

SMT COMMON MODE CHOKES

for PoE+ Applications

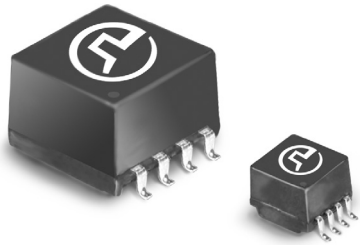

- RoHS peak reflow temperature rating 245°C
- Meets IEEE 802.3 specification

Electrical Specifications @ 25°C - Operating Temperature -0°C to +70°C

Part Number ^{1,2,3}	SRF (TYP)	MAX Inter-winding Capacitance (pF)	Leakage Inductance (μH MAX)	OCL (±35%)	DC Resistance (Ω MAX)	Impedance Curves ⁴
H6500NL	110 MHz	8	0.12	15 μH	0.15	1
H6501NL	60 MHz	15	0.15	30 μH	0.20	2
H6502NL	42 MHz	18	0.20	60 μH	0.25	3
H6503NL	26 MHz	25	0.25	100 μH	0.30	4
H6504NL	7.0 MHz	10	0.20	250 μH	0.18	5
H6505NL	5.5 MHz	18	0.25	500 μH	0.28	6
H6506NL	2.6 MHz	30	0.30	1 mH	0.35	7
H6507NL	300 MHz	120	1.0	20 mH	1.50	8

Notes:

- Turns Ratio: (1 - 4) : (5 - 8) = 1:1 (±3%)
- Between channel isolation: 500 VAC @ 60 seconds
- Polarity: per schematic
- For Tape & Reel** packaging, add a "T" suffix to the end of the part number when ordering (i. e. **H6500NL** becomes **H6500NLT**).
- See charts page 2

USA 858 674 8100

Germany 49 7032 7806 0

Singapore 65 6287 8998

Shanghai 86 21 62787060

China 86 755 33966678

Taiwan 886 3 4356768

SMT COMMON MODE CHOKES

for PoE+ Applications



Mechanicals

Schematics

H6500NL-H6506NL

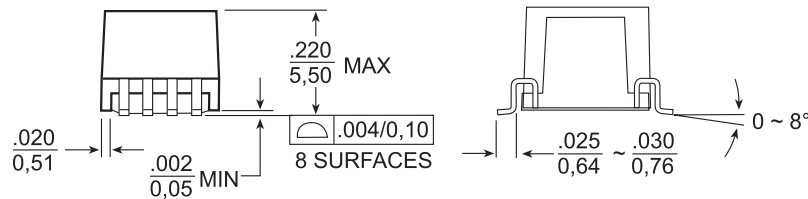
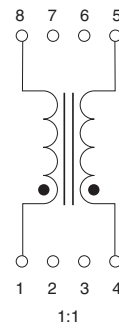
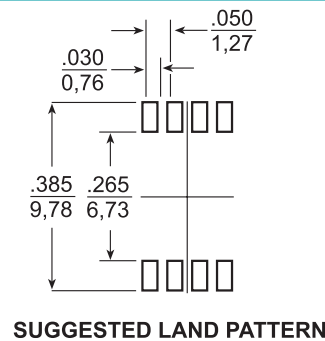
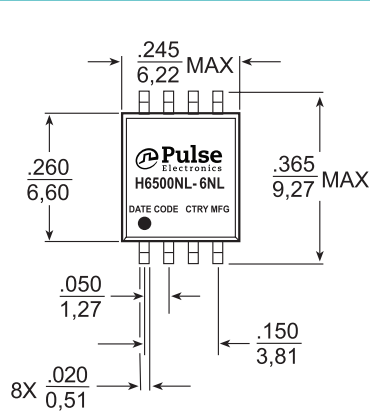

Weight0.4 grams **Dimensions:** $\frac{\text{Inches}}{\text{mm}}$
 Tape & Reel750
 Tube85 Unless otherwise specified, all tolerances are $\pm \begin{matrix} .010 \\ 0.25 \end{matrix}$

Mechanicals

Schematics

H6507NL

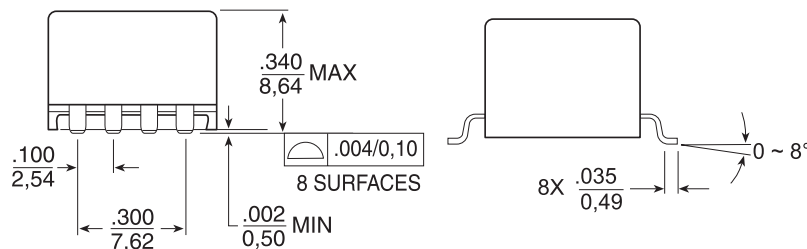
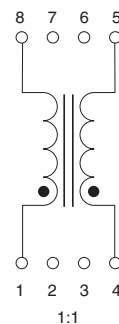
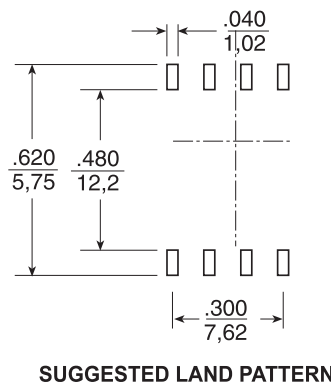
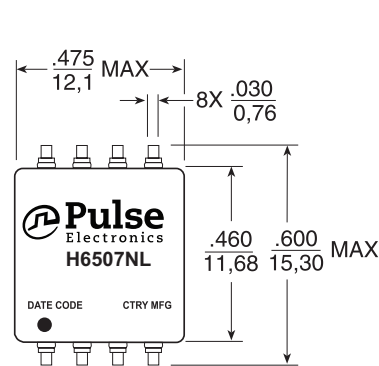

Weight1.8 grams
 Tape & Reel250
 Tube40

SMT COMMON MODE CHOKES

for PoE+ Applications

Impedance Curves

H6500NL-H6506NL

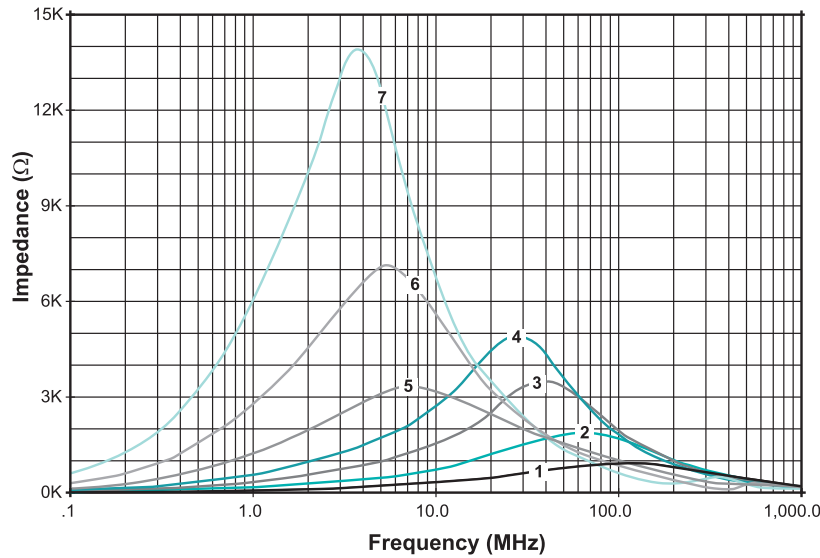

Impedance Curves

H6507NL

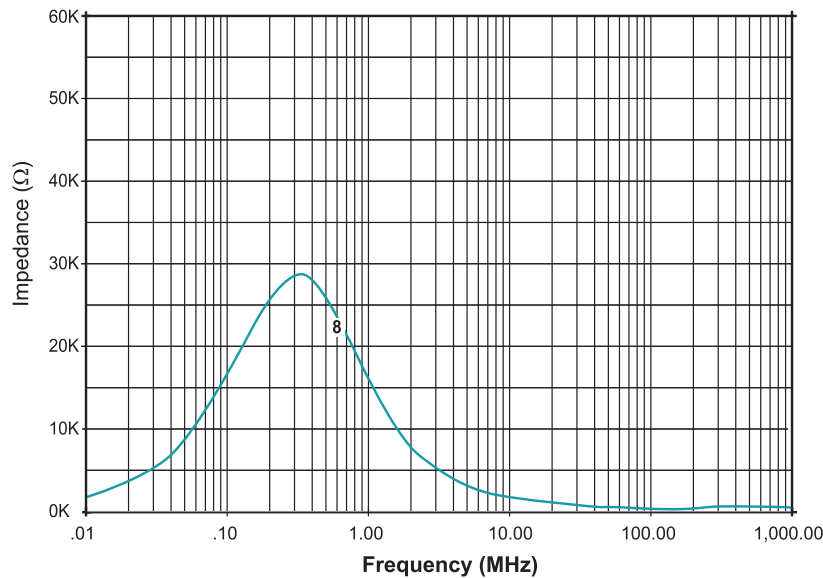

For More Information

Pulse Worldwide Headquarters
12220 World Trade Drive
San Diego, CA
92128
U.S.A.

Tel: 858 674 8100

Pulse Europe
Einsteinstrasse 1
D-71083 Herrenberg
Germany

Tel: 49 7032 7806

Pulse China Headquarters
B402, Shenzhen Academy of
Aerospace Technol-
ogy Bldg.
10th Kejian Road
High-Tech Zone
Nanshan District
Shenzen, PR China
518057

Pulse North China
Room 2704/2705
Super Ocean Finance
Ctr.
2067 Yan An Road
West
Shanghai 200336
China

Pulse South Asia
135 Joo Seng Road
#03-02
PM Industrial Bldg.
Singapore 368363

Tel: 65 6287 8998
Fax: 65 6287 8998

Pulse North Asia
3F, No. 198
Zhongyuan Road
Zhongli City
Taoyuan County 320
Taiwan R. O. C.
Tel: 886 3 4356768
Fax: 886 3 4356823
(Pulse)

Performance warranty of products offered on this data sheet is limited to the parameters specified. Data is subject to change without notice. Other brand and product names mentioned herein may be trademarks or registered trademarks of their respective owners. © Copyright, 2012. Pulse Electronics, Inc. All rights reserved.