

N- and P-Channel Enhancement Mode MOSFET

MTC4603H8

	N-CH	P-CH
BV _{DSS}	30V	-30V
I _D @V _{GS} =10V(-10V), T _A =25°C	10.3A	-9.6A
I _D @V _{GS} =10V(-10V), T _C =25°C	32.8A	-30.3A
R _{DS(on)(typ)} @V _{GS} =10V(-10V)	10.0mΩ	15.0mΩ
R _{DS(on)(typ)} @V _{GS} =4.5V(-4.5V)	12.7mΩ	21.6mΩ

Features

- Simple drive requirement
- Low on-resistance
- Fast switching speed
- Pb-free lead plating and halogen-free package

Equivalent Circuit

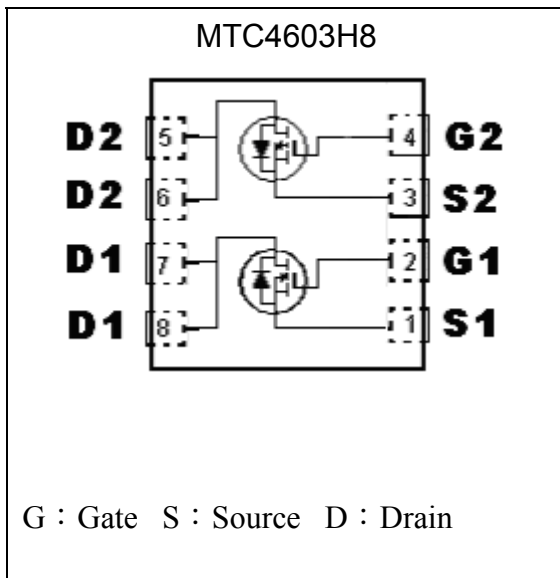

Outline

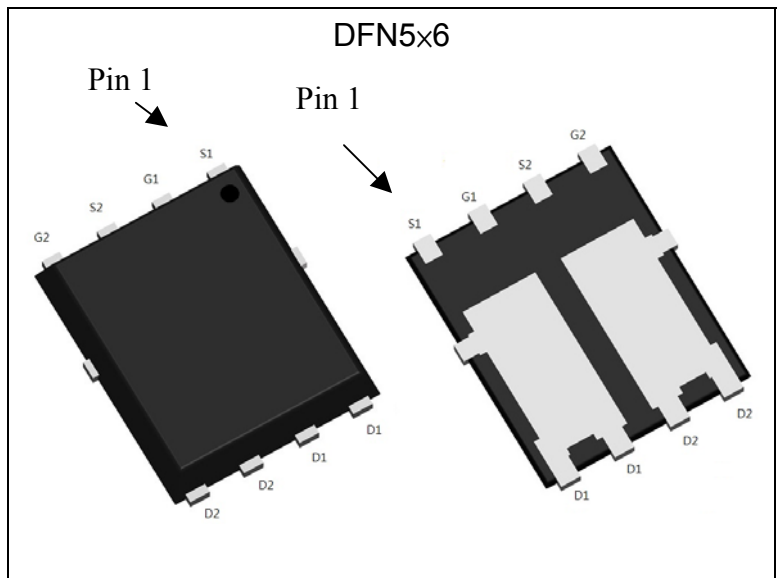

Ordering Information

Device	Package	Shipping
MTC4603H8-0-T6-G	DFN 5 × 6 (Pb-free lead plating & halogen-free package)	3000 pcs / Tape & Reel

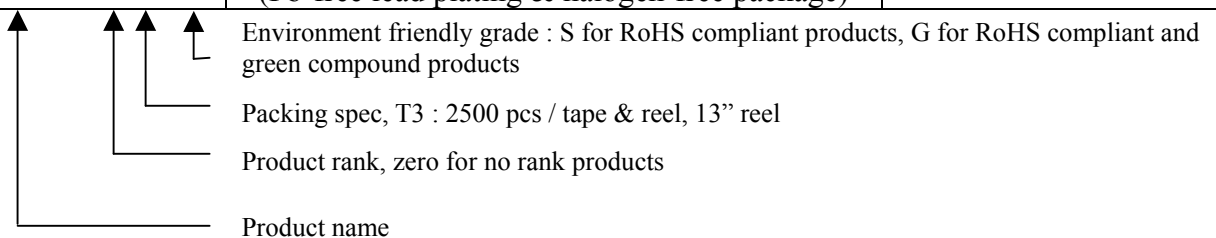



Absolute Maximum Ratings (T_C=25°C, unless otherwise noted)

Parameter	Symbol	Limits		Unit	
		N-channel	P-channel		
Drain-Source Breakdown Voltage	BV _{DSS}	30	-30	V	
Gate-Source Voltage	V _{GS}	±20	±20		
Continuous Drain Current	T _A =25 °C, V _{GS} =10V (-10V)	I _{DSM}	10.3	-9.6	A
	T _A =70 °C, V _{GS} =10V (-10V)		8.2	-7.7	
	T _C =25 °C, V _{GS} =10V (-10V)	I _D	32.8	-30.3	
	T _C =100 °C, V _{GS} =10V (-10V)		20.7	-19.2	
Pulsed Drain Current (Note 1 & 2)	I _{DM}	46	-43		
Single Pulse Avalanche Current @ L=0.1mH	I _{AS}	30	34		
Single Pulse Avalanche Energy (Note 4)	E _{AS}	60.5	108	mJ	
Power Dissipation	T _A =25 °C	P _{DSM}	2.5 (Note 3)		W
	T _A =70 °C		1.6 (Note 3)		
	T _C =25 °C	P _D	25		
	T _C =100 °C		10		
Operating Junction and Storage Temperature Range	T _j ; T _{stg}	-55~+150		°C	

Thermal Data

Parameter	Symbol	Value	Unit
Thermal Resistance, Junction-to-case, max	R _{θJC}	5	°C/W
Thermal Resistance, Junction-to-ambient, max	R _{θJA}	50 (Note 3)	

- Note : 1. Pulse width limited by maximum junction temperature
 2. Duty cycle ≤ 1%
 3. Surface mounted on 1 in² copper pad of FR-4 board, t ≤ 10s; 125°C/W when mounted on minimum copper pad.
 4. For N-channel, L=1mH, V_{DD}=15V, V_{GS}=10V, I_{AS}=11A; for P-channel, L=3mH, V_{DD}=-15V, V_{GS}=-10V, I_{AS}=-8.5A

N-Channel Electrical Characteristics (T_C=25°C, unless otherwise specified)

Symbol	Min.	Typ.	Max.	Unit	Test Conditions
Static					
BV _{DSS}	30	-	-	V	V _{GS} =0V, I _D =250μA
V _{GS(th)}	1.0	-	2.5		V _{DS} =V _{GS} , I _D =250μA
I _{GSS}	-	-	±100	nA	V _{GS} =±20V, V _{DS} =0V
I _{DSS}	-	-	1	μA	V _{DS} =24V, V _{GS} =0V
	-	-	25		V _{DS} =24V, V _{GS} =0, T _j =125°C
*R _{DSON}	-	10	13	mΩ	I _D =6A, V _{GS} =10V
	-	12.7	17		I _D =4A, V _{GS} =4.5V
*G _{FS}	-	7	-	S	V _{DS} =10V, I _D =6A
Dynamic					
C _{iss}	-	788	1180	pF	V _{DS} =25V, V _{GS} =0V, f=1MHz
C _{oss}	-	91	-		
C _{rss}	-	73	-		



*td(ON)	-	8.8	-	ns	V _{DS} =15V, I _D =6A, V _{GS} =10V, R _G =1 Ω
*tr	-	18	-		
*td(OFF)	-	37	-		
*tf	-	6.6	-		
*Qg	-	10.8	16.2	nC	V _{DS} =24V, I _D =6A, V _{GS} =4.5V
*Qgs	-	2.2	-		
*Qgd	-	5.6	-		
Body Diode					
*V _{SD}	-	0.83	1.2	V	V _{GS} =0V, I _S =6A
*trr	-	8.9	-	ns	I _F =6A, dI _F /dt=100A/μs
*Qrr	-	3.9	-	nC	

*Pulse Test : Pulse Width ≤300μs, Duty Cycle ≤2%

P-Channel Electrical Characteristics (T_c=25°C, unless otherwise specified)

Symbol	Min.	Typ.	Max.	Unit	Test Conditions
Static					
BV _{DSS}	-30	-	-	V	V _{GS} =0V, I _D =-250μA
V _{GS(th)}	-1.0	-	-2.5		V _{DS} =V _{GS} , I _D =-250μA
I _{GSS}	-	-	±100	nA	V _{GS} =±20V, V _{DS} =0V
I _{DSS}	-	-	-1	μA	V _{DS} =-24V, V _{GS} =0V
	-	-	-25		V _{DS} =-24V, V _{GS} =0V, T _j =125°C
*R _{Ds(ON)}	-	15.0	20	mΩ	I _D =-6A, V _{GS} =-10V
	-	21.6	30		I _D =-4A, V _{GS} =-4.5V
*G _{FS}	-	11	-	S	V _{DS} =-10V, I _D =-6A
Dynamic					
C _{iss}	-	1471	2210	pF	V _{DS} =-25V, V _{GS} =0V, f=1MHz
C _{oss}	-	151	-		
C _{rss}	-	132	-		
*td(ON)	-	11.2	-	ns	V _{DS} =-15V, I _D =-6A, V _{GS} =-10V, R _G =1 Ω
*tr	-	22	-		
*td(OFF)	-	61.2	-		
*tf	-	11	-		
*Qg	-	18	27	nC	V _{DS} =-24V, I _D =-6A, V _{GS} =-4.5V
*Qgs	-	4.8	-		
*Qgd	-	8.6	-		
Body Diode					
*V _{SD}	-	-0.84	-1.2	V	V _{GS} =0V, I _S =-6A
*trr	-	12.4	-	ns	I _F =-6A, dI _F /dt=100A/μs
*Qrr	-	6.6	-	nC	

*Pulse Test : Pulse Width ≤300μs, Duty Cycle ≤2%

Recommended Soldering Footprint

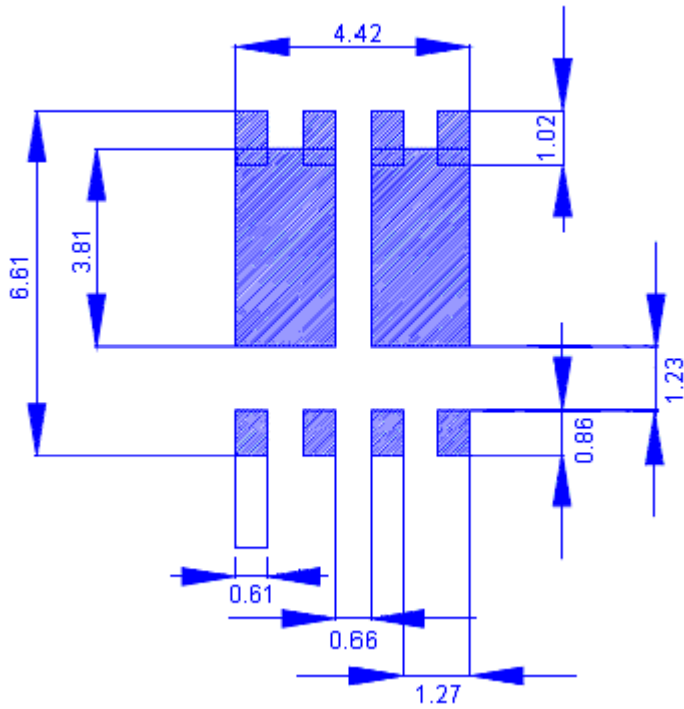

unit : mm

Recommended Stencil Design

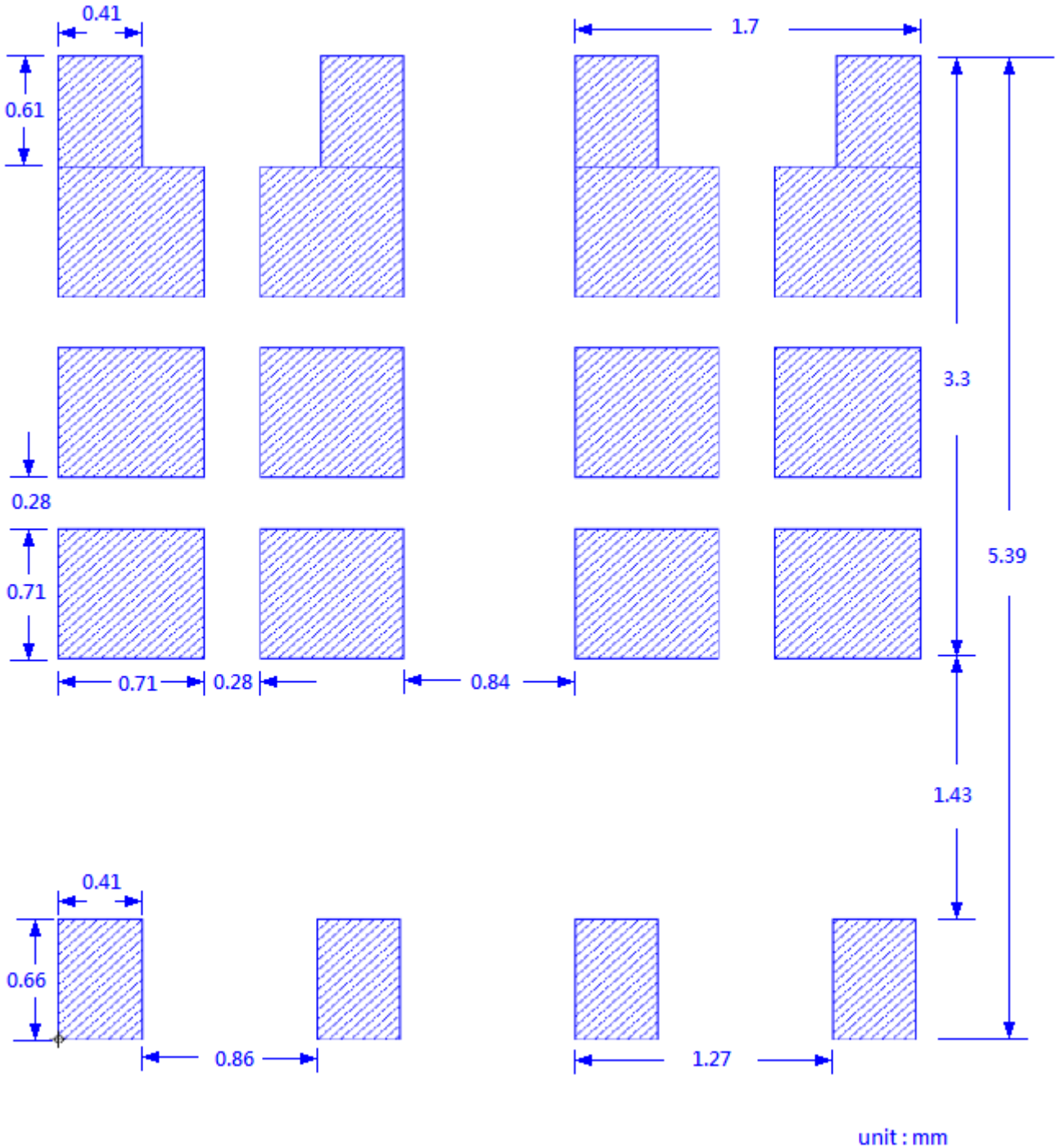

- Note :**
1. Stencil thickness 5 mil (0.127mm)
 2. May need to be adjusted to specific requirements.



Typical Characteristics : Q1(N-channel)

Typical Output Characteristics

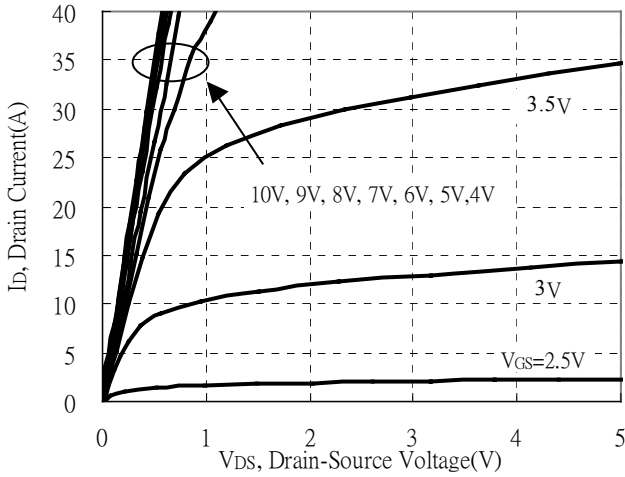

Brekdown Voltage vs Ambient Temperature

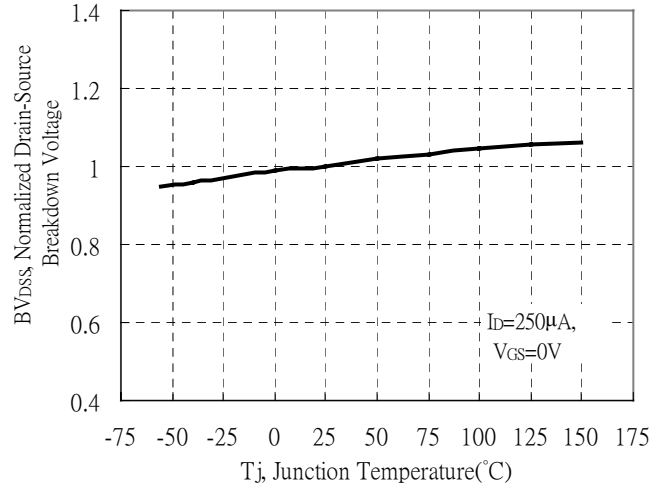

Static Drain-Source On-State resistance vs Drain Current

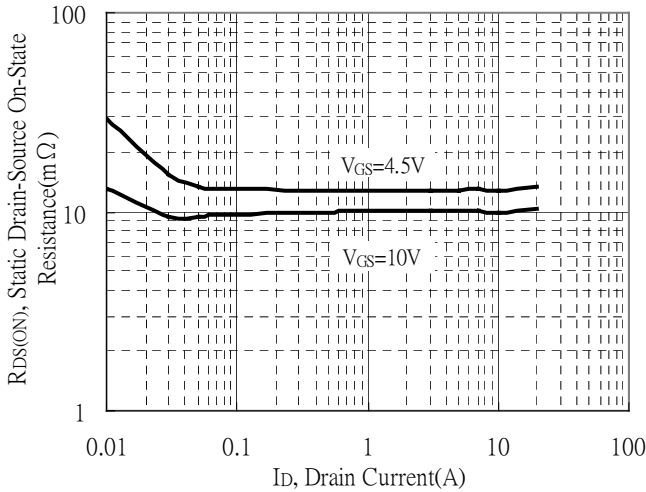

Reverse Drain Current vs Source-Drain Voltage

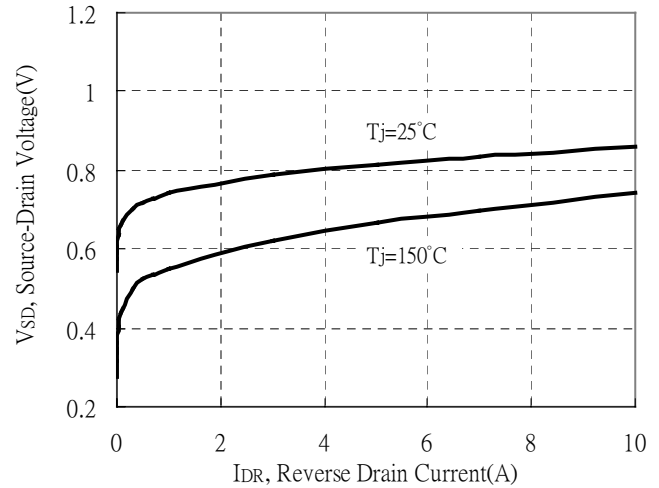

Static Drain-Source On-State Resistance vs Gate-Source Voltage

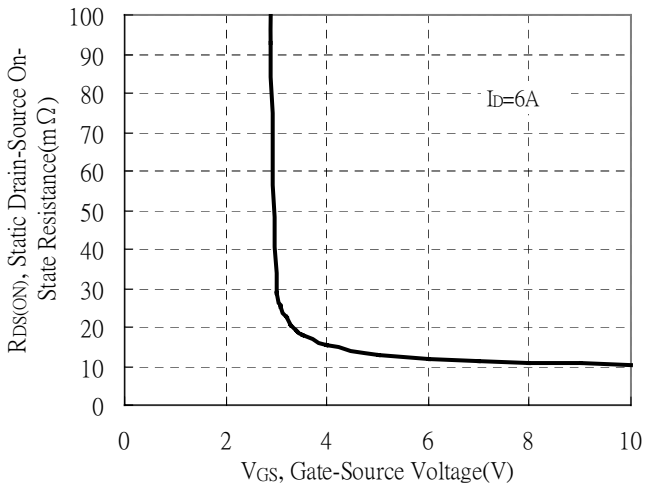

Drain-Source On-State Resistance vs Junction Temperature

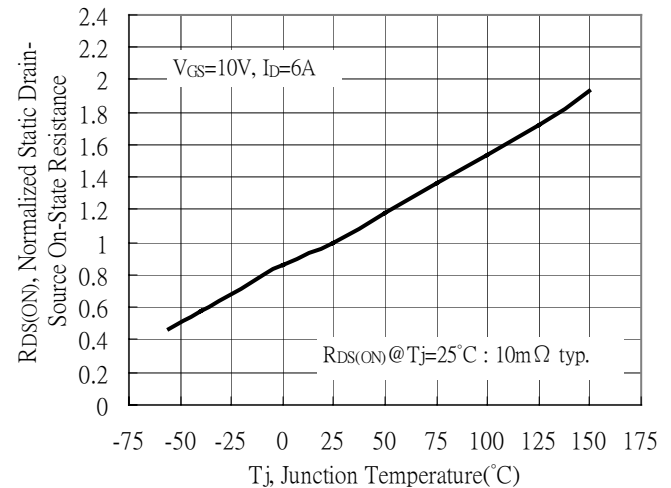

Typical Characteristics(Cont.) : Q1(N-channel)

Capacitance vs Drain-to-Source Voltage

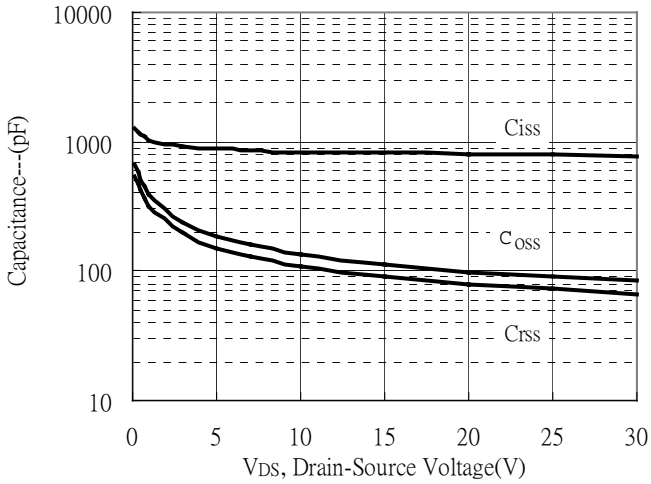

Threshold Voltage vs Junction Temperature

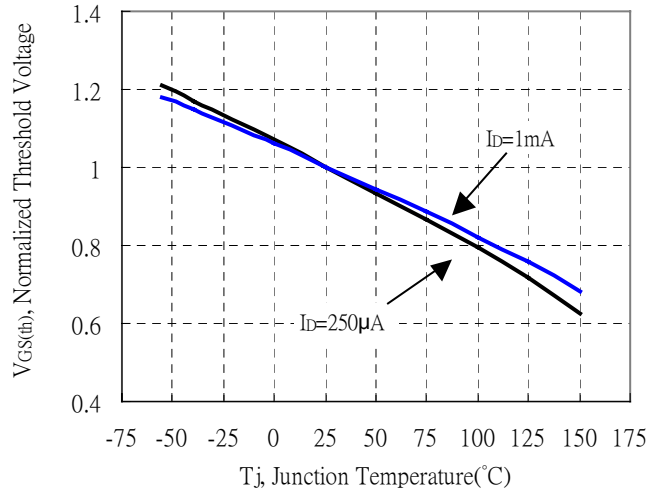

Forward Transfer Admittance vs Drain Current

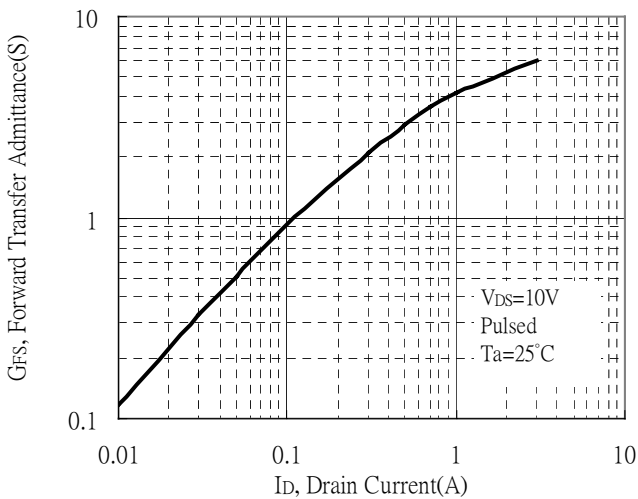

Gate Charge Characteristics

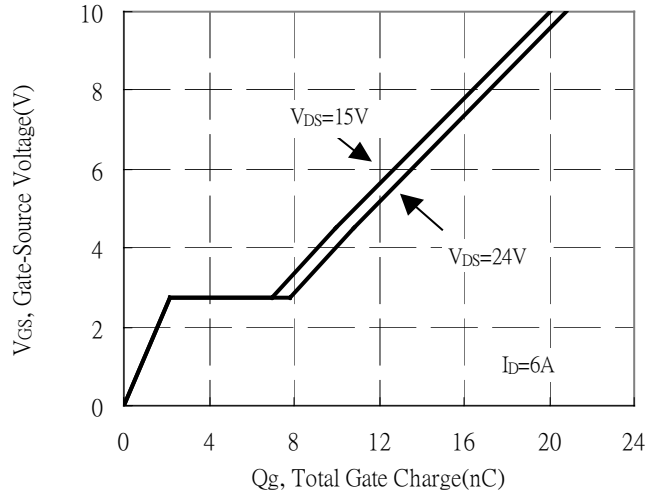

Maximum Safe Operating Area

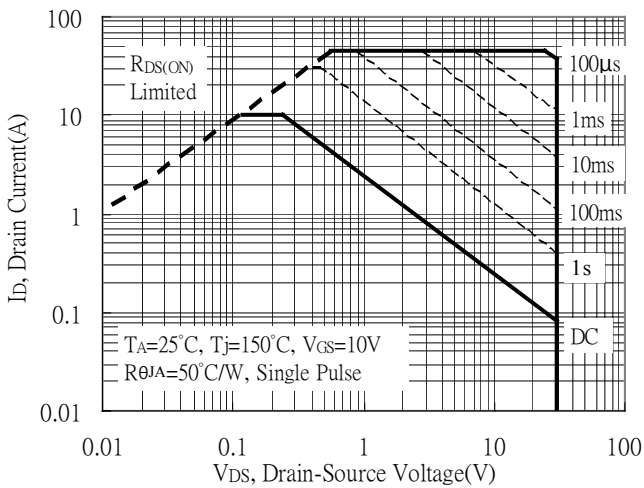

Maximum Drain Current vs Junction Temperature

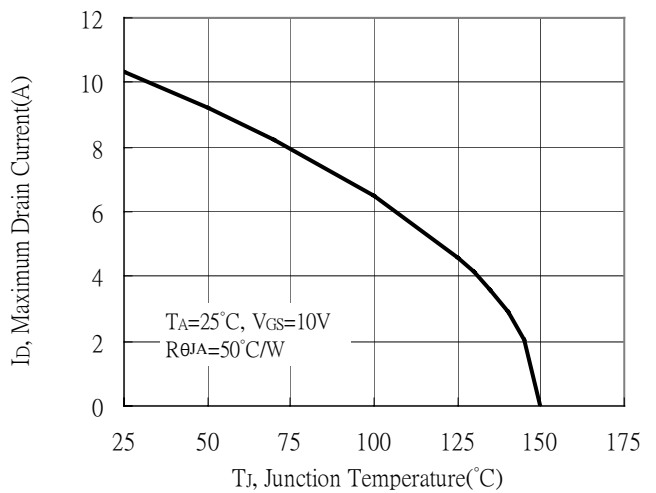



Typical Characteristics(Cont.) : Q1(N-channel)

Single Pulse Power Rating, Junction to Ambient
 (Note on page 2)

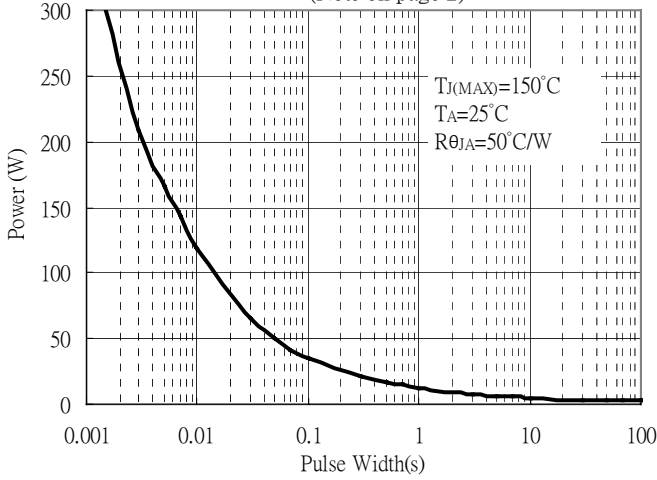

Typical Transfer Characteristics

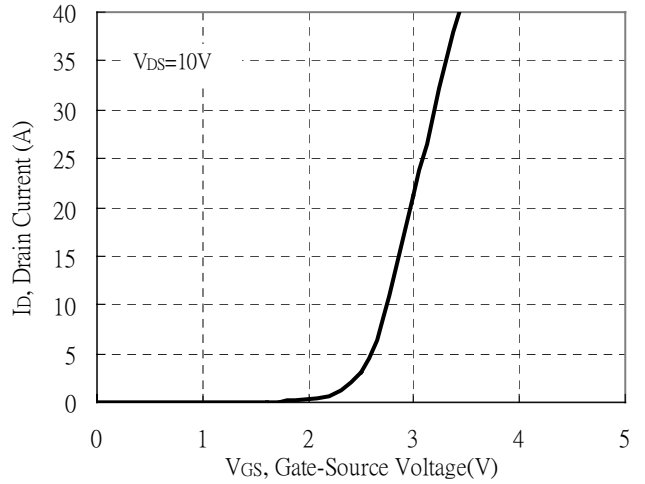

Transient Thermal Response Curves

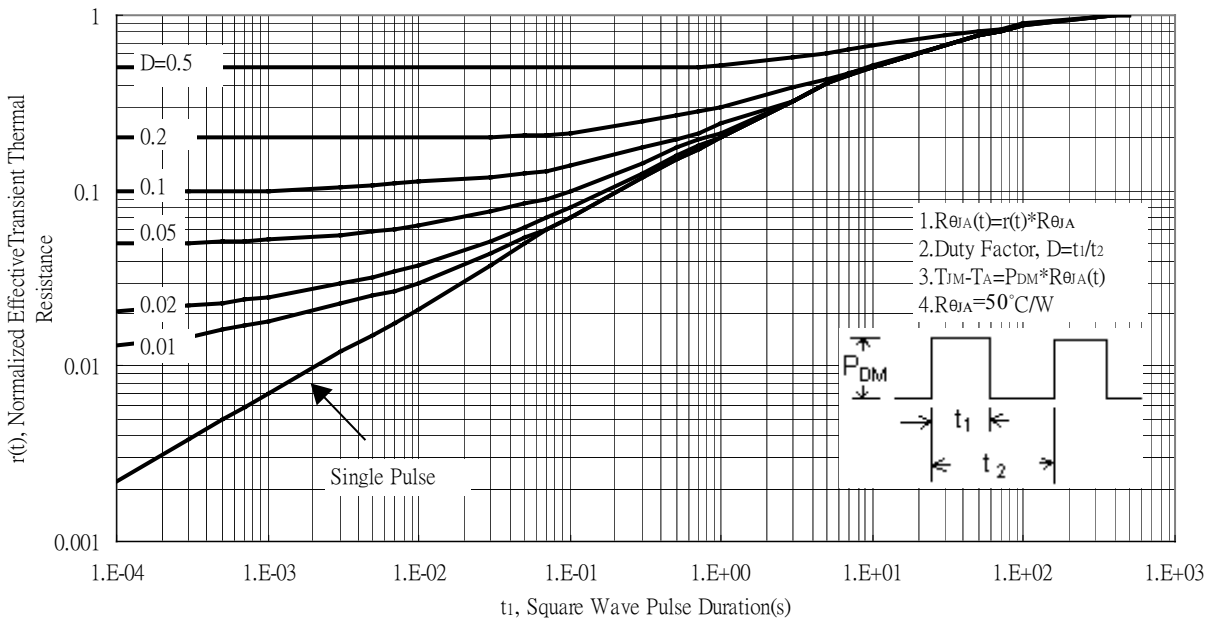

Typical Characteristics : Q2(P-channel)

Typical Output Characteristics

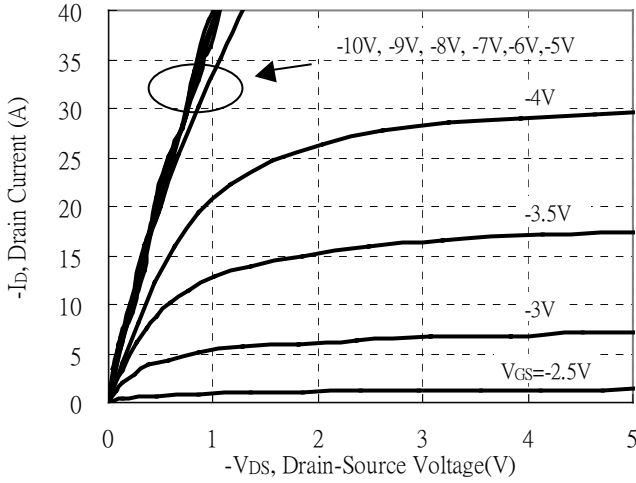

Brekdown Voltage vs Ambient Temperature

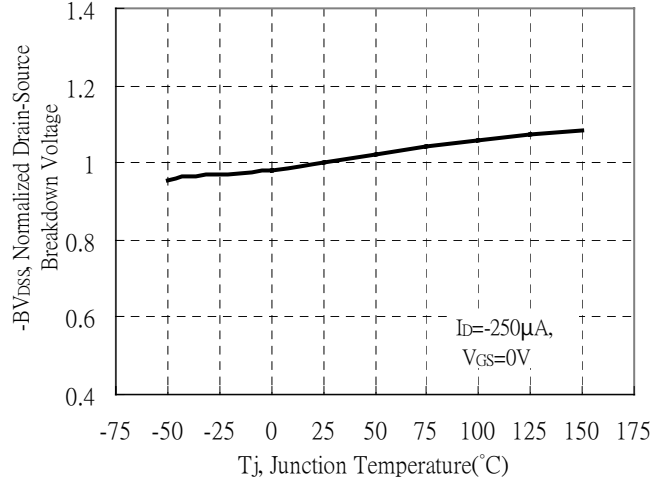

Static Drain-Source On-State resistance vs Drain Current

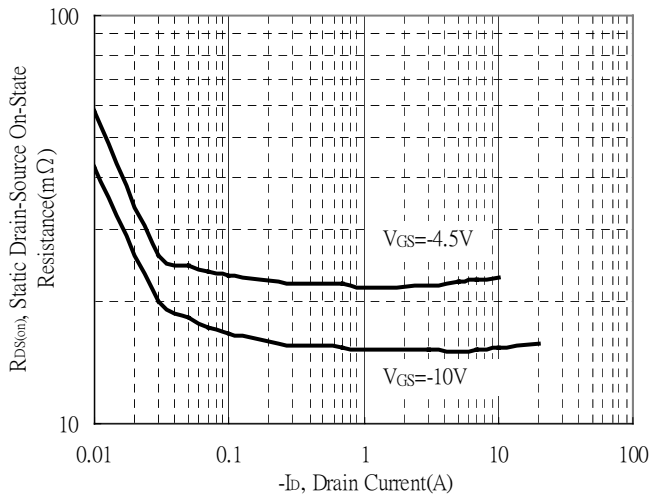

Source Drain Current vs Source-Drain Voltage

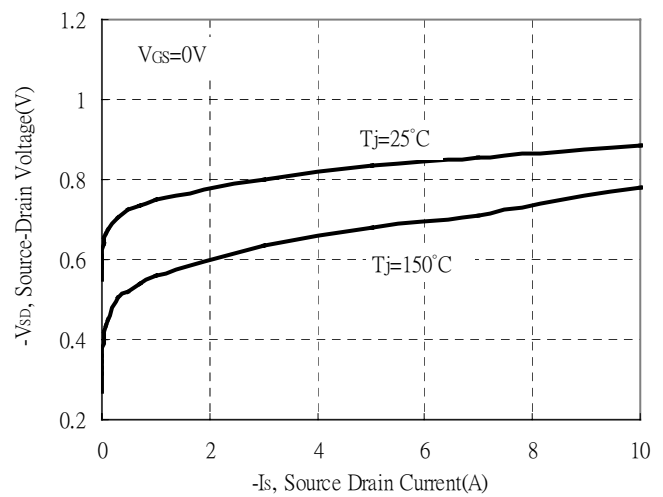

Static Drain-Source On-State Resistance vs Gate-Source Voltage

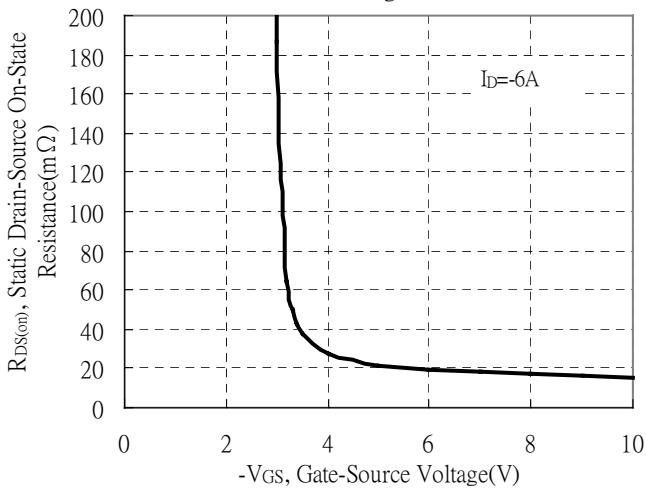

Drain-Source On-State Resistance vs Junction Temperature

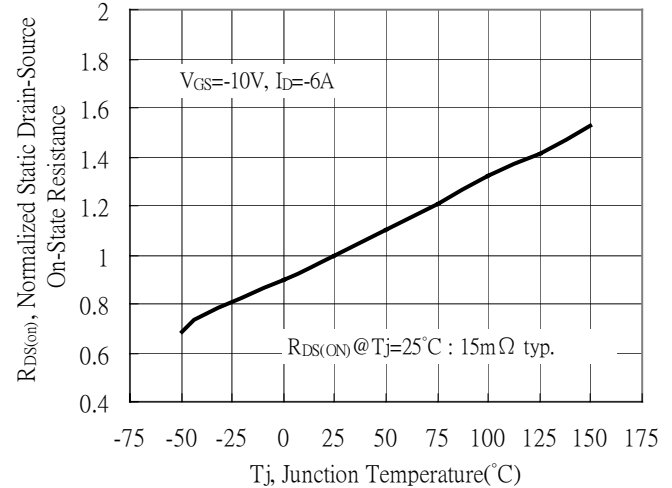

Typical Characteristics(Cont.) : Q2(P-channel)

Capacitance vs Drain-to-Source Voltage

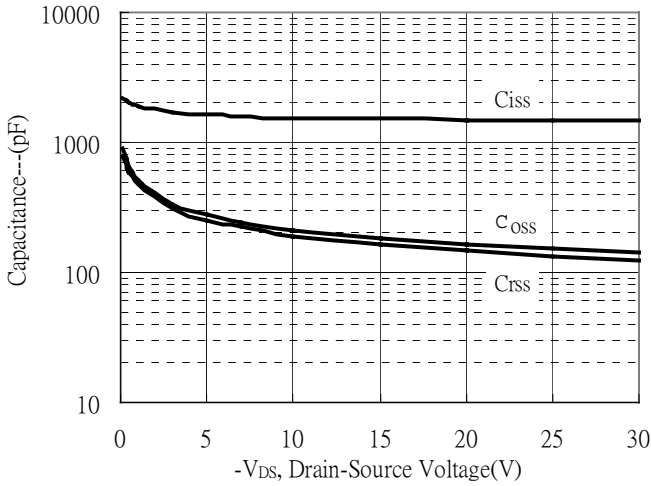

Threshold Voltage vs Junction Temperature

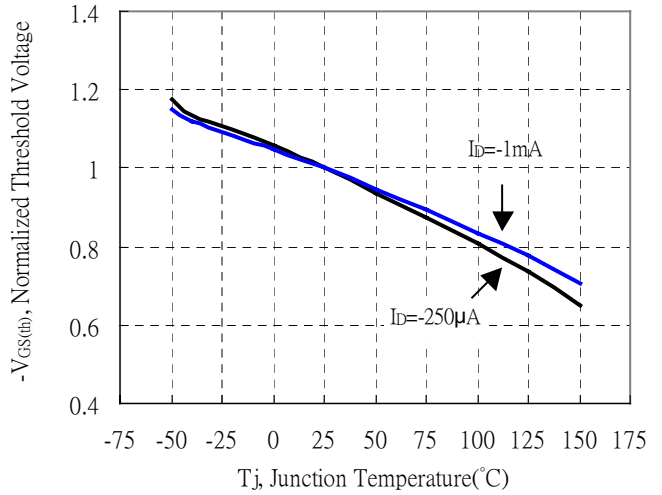

Forward Transfer Admittance vs Drain Current

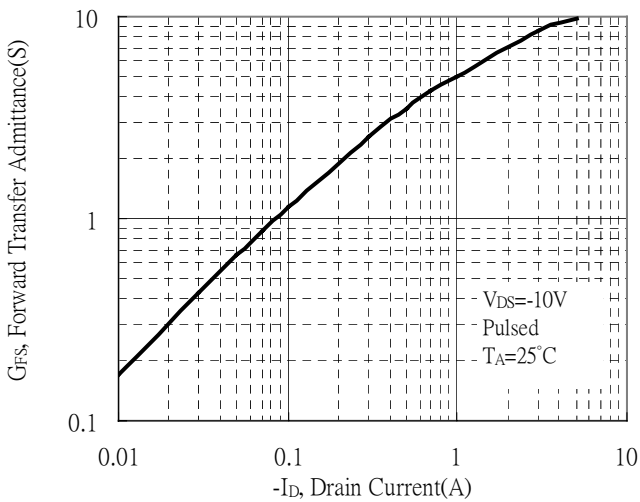

Gate Charge Characteristics

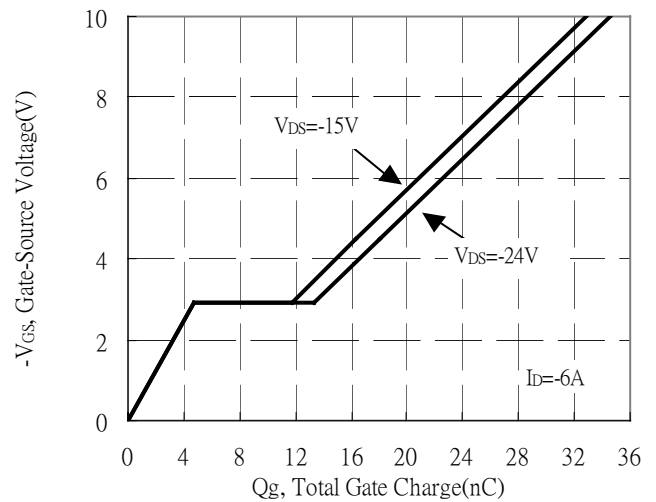

Maximum Safe Operating Area

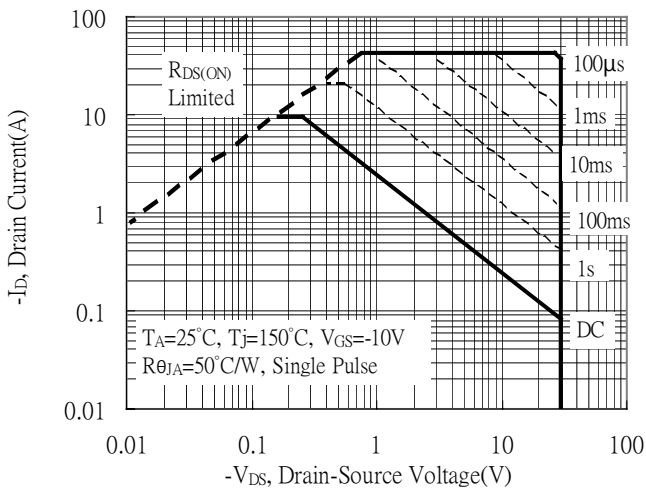

Maximum Drain Current vs Junction Temperature

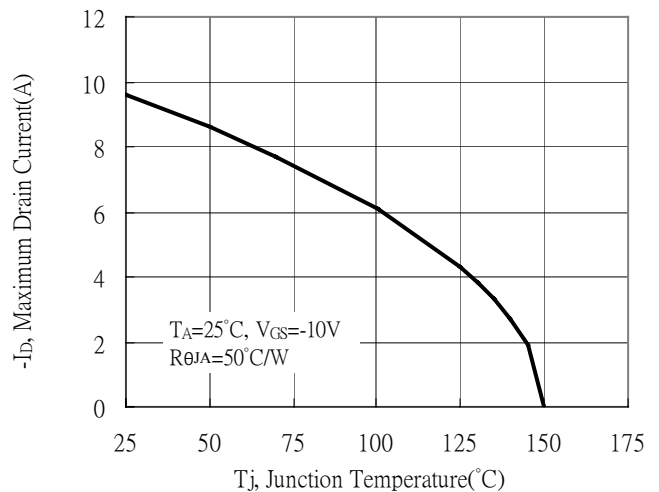

Typical Characteristics(Cont.) : Q2(P-channel)

Single Pulse Power Rating, Junction to Ambient
 (Note on page 2)

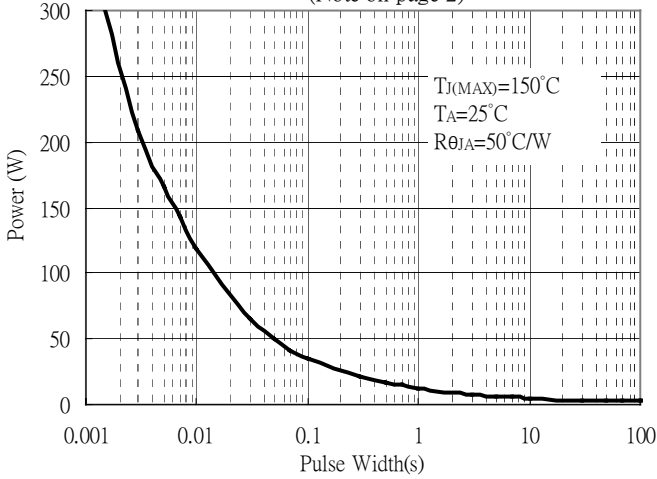

Typical Transfer Characteristics

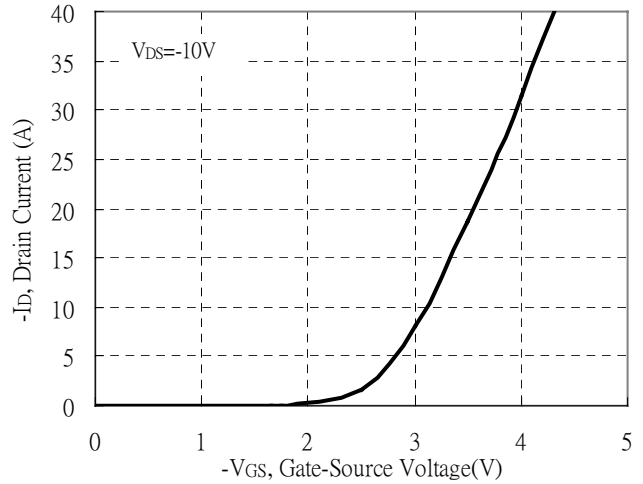

Transient Thermal Response Curves

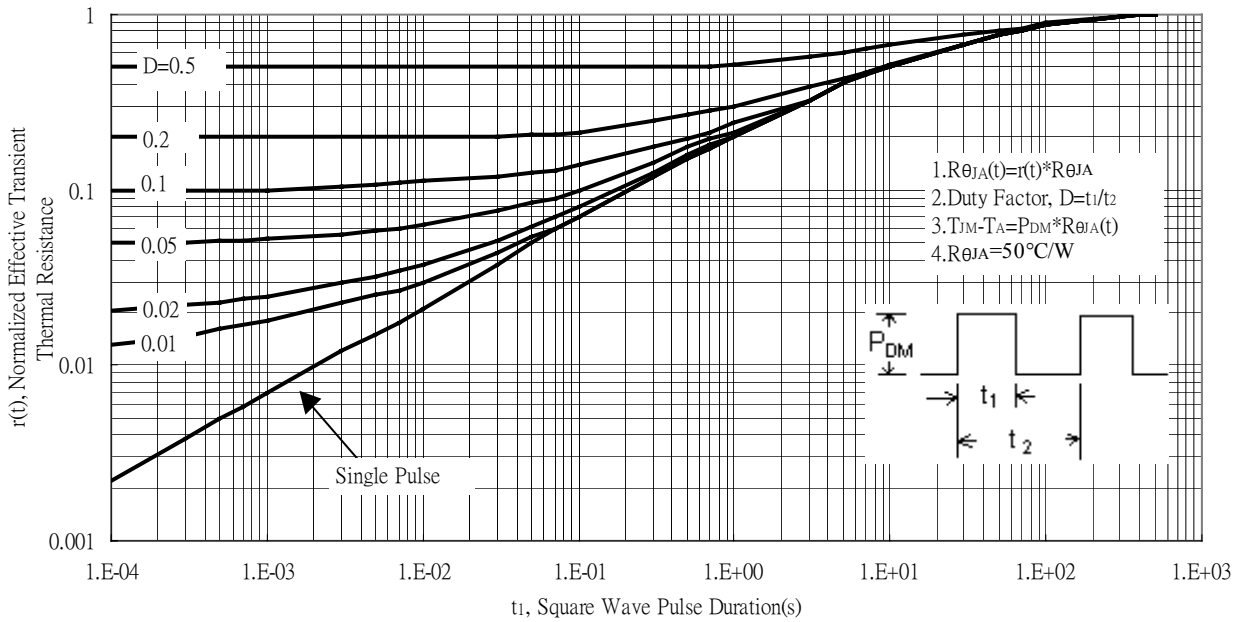

Reel Dimension

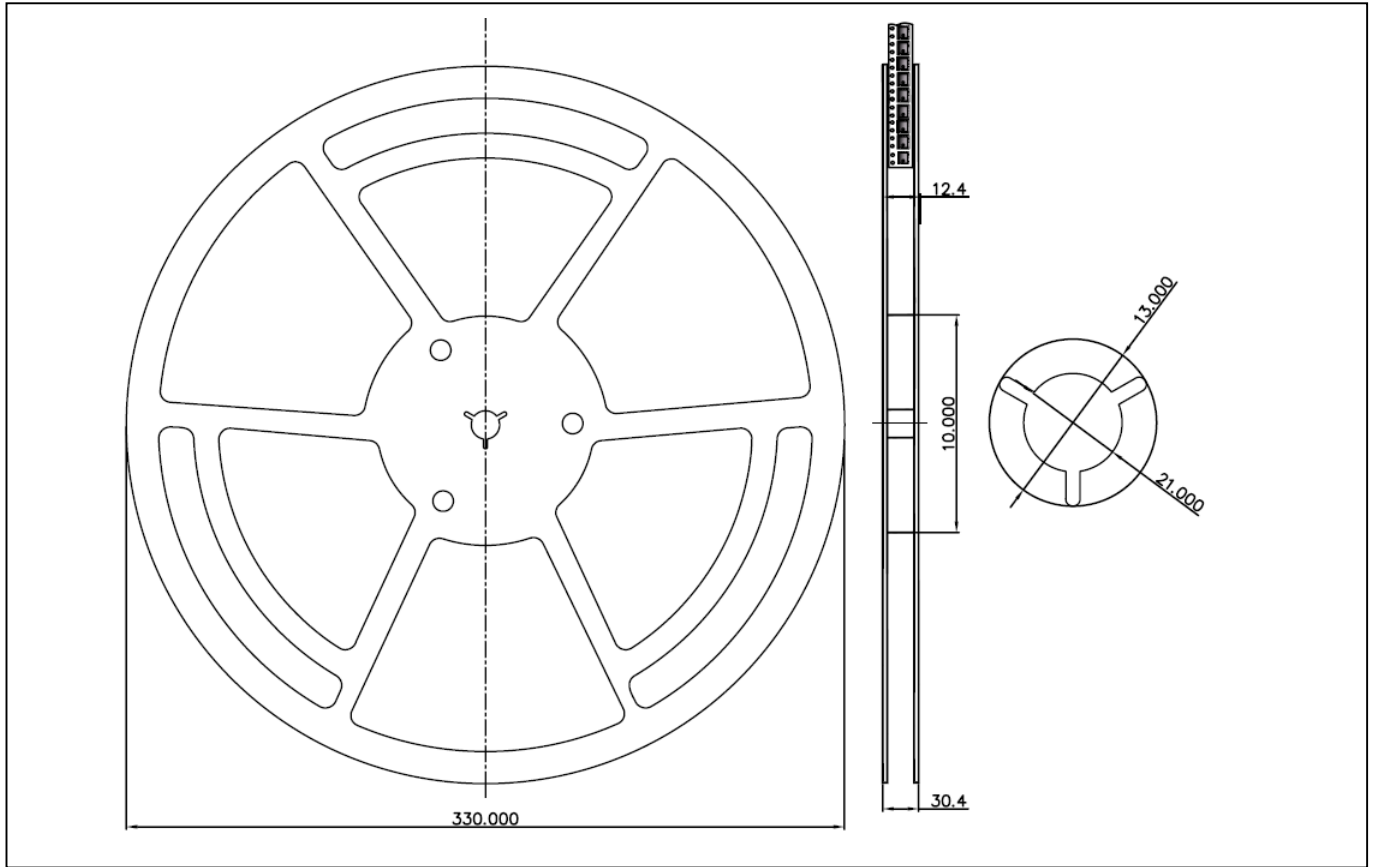

Carrier Tape Dimension

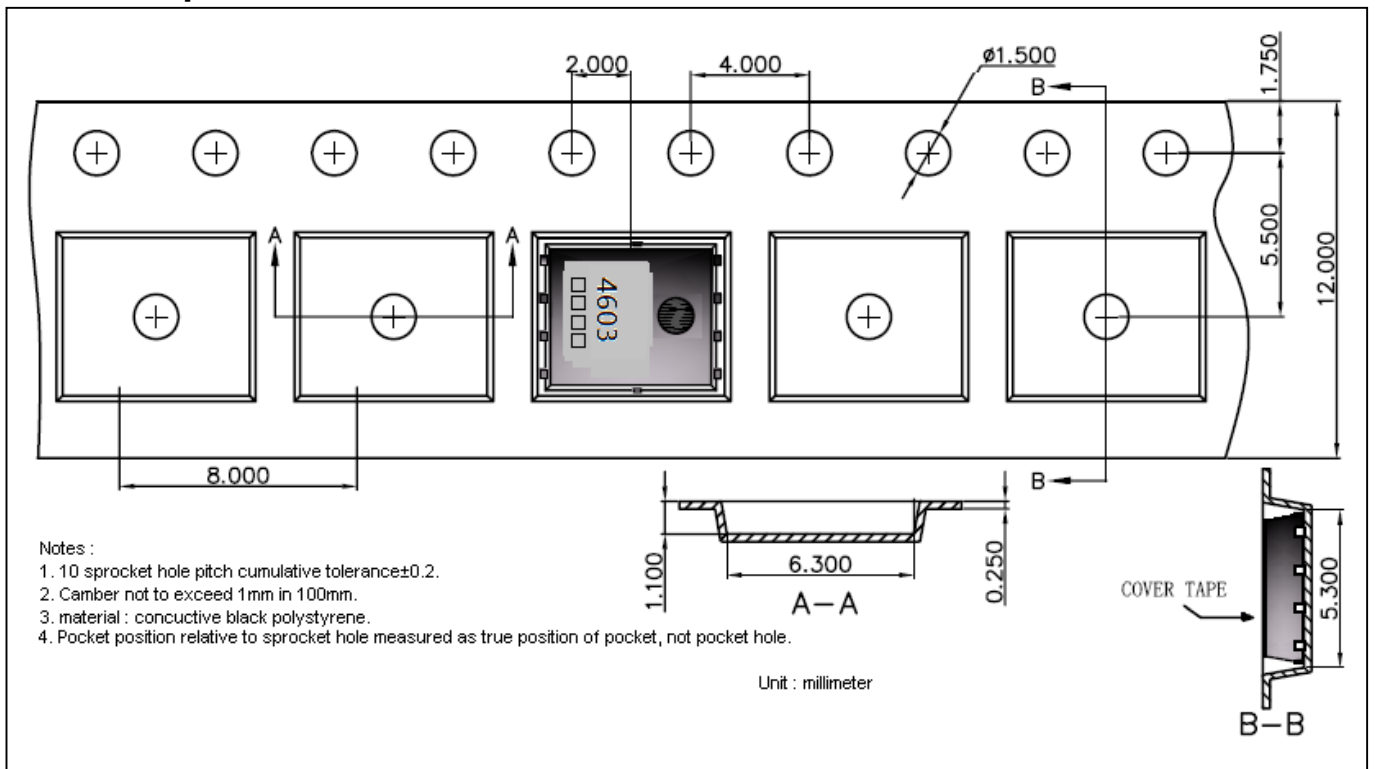

Recommended wave soldering condition

Product	Peak Temperature	Soldering Time
Pb-free devices	260 +0/-5 °C	5 +1/-1 seconds

Recommended temperature profile for IR reflow

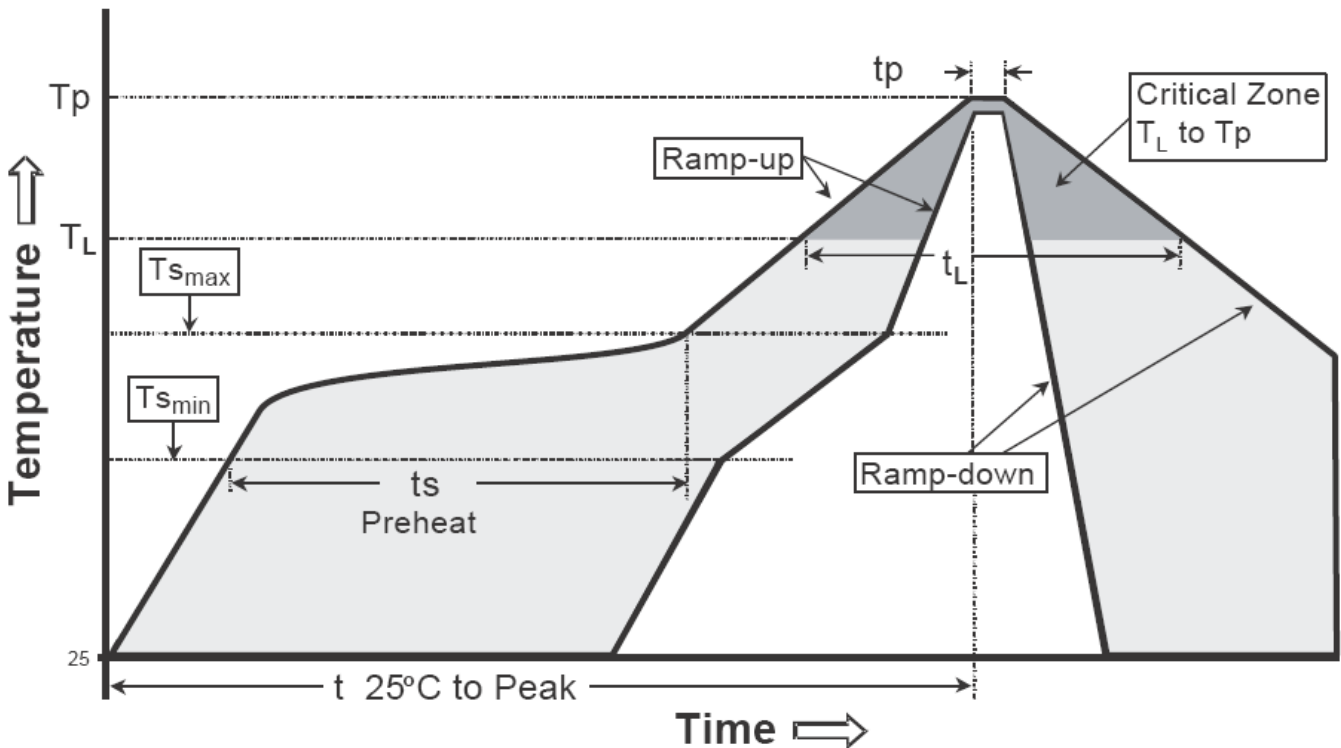

Profile feature	Sn-Pb eutectic Assembly	Pb-free Assembly
Average ramp-up rate (T _{smax} to T _p)	3°C/second max.	3°C/second max.
Preheat		
-Temperature Min(T _{s min})	100°C	150°C
-Temperature Max(T _{s max})	150°C	200°C
-Time(t _{s min} to t _{s max})	60-120 seconds	60-180 seconds
Time maintained above:		
-Temperature (T _L)	183°C	217°C
- Time (t _L)	60-150 seconds	60-150 seconds
Peak Temperature(T _p)	240 +0/-5 °C	260 +0/-5 °C
Time within 5°C of actual peak temperature(tp)	10-30 seconds	20-40 seconds
Ramp down rate	6°C/second max.	6°C/second max.
Time 25 °C to peak temperature	6 minutes max.	8 minutes max.

Note : All temperatures refer to topside of the package, measured on the package body surface.

DFN5x6 Dimension

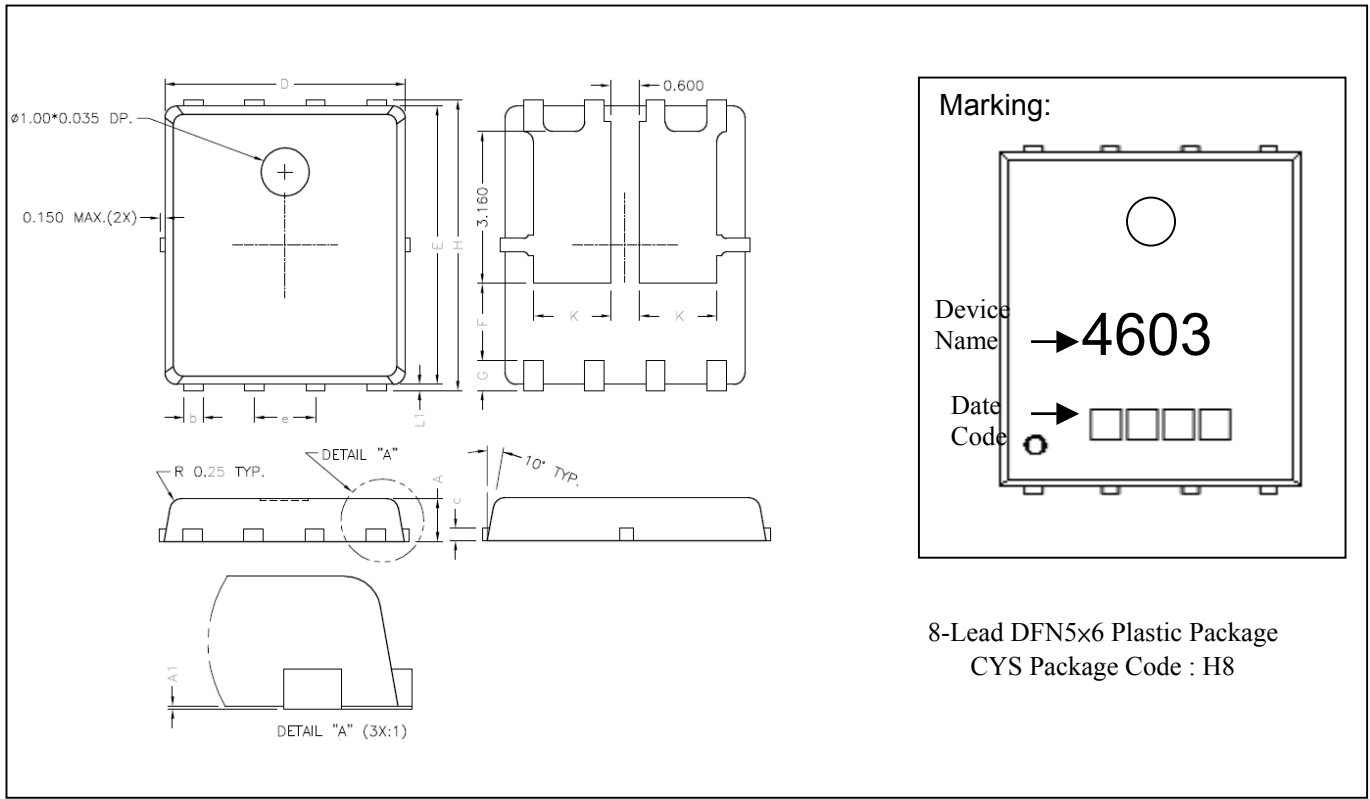

8-Lead DFN5x6 Plastic Package
 CYS Package Code : H8

DIM	Millimeters		Inches		DIM	Millimeters		Inches	
	Min.	Max.	Min.	Max.		Min.	Max.	Min.	Max.
A	0.80	1.00	0.031	0.039	E	5.70	5.90	0.224	0.232
A1	0.00	0.05	0.000	0.002	e	1.27	BSC	0.050	BSC
b	0.35	0.49	0.014	0.019	H	5.95	6.20	0.234	0.244
c	0.254	REF	0.010	REF	L1	0.10	0.18	0.004	0.007
D	4.90	5.10	0.193	0.201	G	0.60	REF	0.024	REF
F	1.60	REF	0.063	REF	K	1.60	REF	0.063	REF

Notes: 1.Controlling dimension: millimeters.
 2.Maximum lead thickness includes lead finish thickness, and minimum lead thickness is the minimum thickness of base material.
 3.If there is any question with packing specification or packing method, please contact your local CYStek sales office.

Material:

- Lead: Pure tin plated.
- Mold Compound: Epoxy resin family, flammability solid burning class: UL94V-0.

Important Notice:

- All rights are reserved. Reproduction in whole or in part is prohibited without the prior written approval of CYStek.
- CYStek reserves the right to make changes to its products without notice.
- CYStek **semiconductor products are not warranted to be suitable for use in Life-Support Applications, or systems.**
- CYStek assumes no liability for any consequence of customer product design, infringement of patents, or application assistance.