

SAW BANDPASS FILTER

ACT PART NO.: ACTF8156_897.5MHz_RF SAW_V1.0

Product Type:		Customer:
SAW Filter		
Part NO.:		Customer Part NO.:
ACTF8156_897.5MHz_RF SAW_V1.0		
		Issued Date:

PREPARED BY	CHECKED BY	APPROVED BY

In line with our ongoing policy of product evolution and improvement, the above specification may subject to change without notice

ISO9001 Registered

For quotations or further information please contact us at:

3 The Business Centre, Molly Millars Lane, Wokingham, Berkshire, RG41 2EY, UK

<http://www.actcrystals.com>

Features

- Low-loss RF filter for mobile systems
- Low amplitude ripple
- No matching network required for operation at 50Ω
- Ceramic package for **Surface Mounted Technology (SMT)**
- Lead-free production and **RoHS** compliant

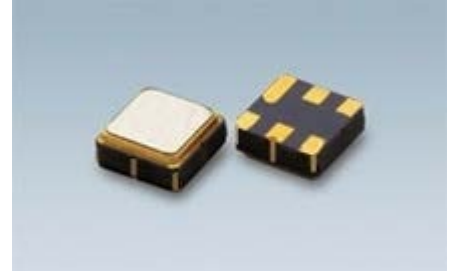

Package Dimensions

Ceramic Package: **DCC6C**

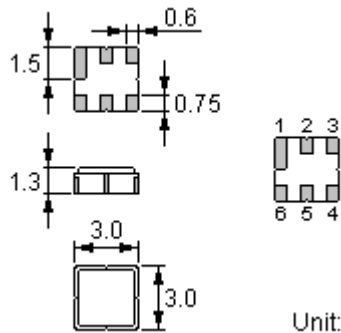

Unit: mm

Pin Configuration

2	Input
5	Output
1, 3, 4, 6	Ground

Marking



Top View, Laser Marking

"ACT": Manufacturer's mark

"F": SAW filter

"8156": Part number

" - ": Terminal 1

"*": Lot number (The code shown below varies in a 4-year cycle)

Code	1	2	3	4	5	6	7	8	9	10	11	12
2010	N	P	Q	R	S	T	U	V	W	X	Y	Z
2011	a	b	c	d	e	f	g	h	i	j	k	m
2012	n	p	q	r	s	t	u	v	w	x	y	z
2013	A	B	C	D	E	F	G	H	J	K	L	M

Maximum Ratings

Rating		Value	Unit
Input Power Level	P	13.5 dBm CW, $T_a=85^\circ\text{C}$, life time>10 years	
		20dBm CW, $T_a=85^\circ\text{C}$, pass band top frequency, test 1000 hours continuously ,electrical characters meet demand;	
		23dBm CW, $T_a=85^\circ\text{C}$, pass band top frequency, test 2 hours continuously ,electrical characters meet demand;	
DC Voltage	V_{DC}	12	V
Operating Temperature Range	T_A	-40 ~ +85	$^\circ\text{C}$
Storage Temperature Range	T_{stg}	-40 ~ +85	$^\circ\text{C}$

Electrical Characteristics

Parameter	Unit	Minimum	Typical	Maximum
Center frequency	MHz		897.5	
Useable bandwidth	MHz		35	
Insertion Loss (880~915MHz)	dB		2.0	2.3
Amplitude Variation(880~915MHz)	dB		0.8	1.0
Absolute Attenuation	0.3~620MHz	dB	40	60
	620~840MHz	dB	45	60
	925~935MHz	dB	10	16
	935~960MHz	dB	20	30
	1200~1400MHz	dB	40	50
	1950~1990MHz	dB	40	45
	1990~2035MHz	dB	38	43
	3000~3400MHz	dB	20	23
3400~5000MHz	dB	10	12	
Input/Output VSWR (880~915MHz)	dB		1.8: 1	2.0: 1
RF Power	dBm			+23
Input/Output Impedance	ohm		50	

RoHS Compliant

Electrostatic Sensitive Device

Typical Frequency Response

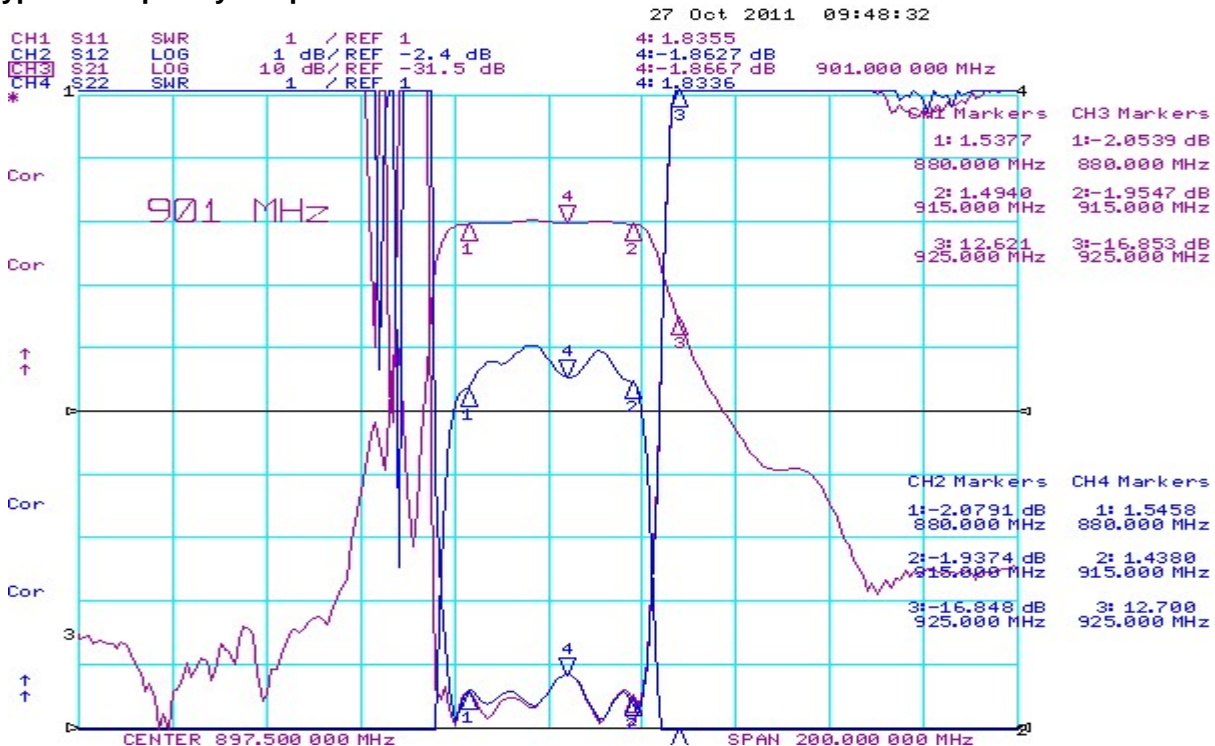

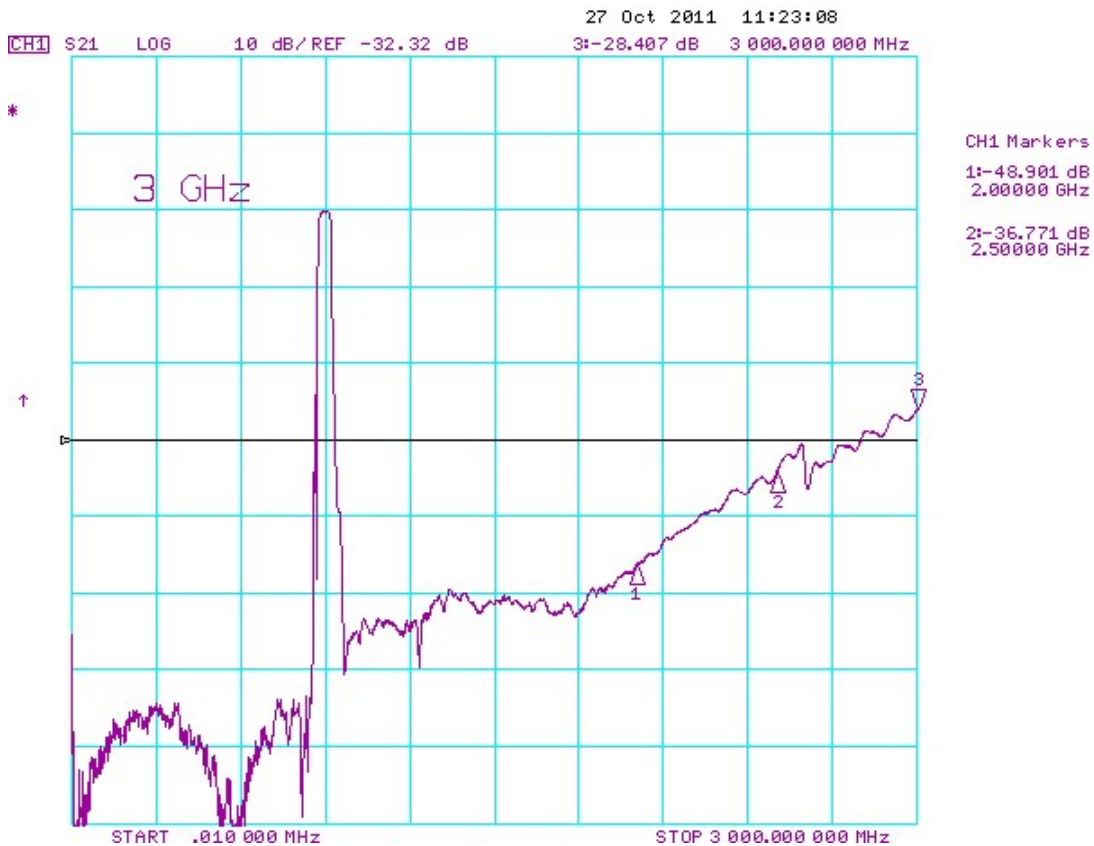

Stability Characteristics

	Test item	Condition of test
1	Mechanical shock	(a) Drops: 3 times on concrete floor (b) Height: 1.0 m
2	Vibration resistance	(a) Frequency of vibration: 10~55Hz (c) Directions: X,Y and Z (b) Amplitude: 1.5 mm (d) Duration: 2 hours
3	Moisture resistance	(a) Condition: 40°C, 90~95% R.H. (c) Wait 4 hours before measurement (b) Duration: 96 hours
4	Climatic sequence	(a) +70°C for 16 hours (c) -25°C for 2 hours (e) Wait 4 hours before measurement (b) +55°C for 24 hours, 90~95% R.H. (d) +40°C for 24 hours, 90~95% R.H.
5	High temperature exposure	(a) Temperature: 70°C (c) Wait 4 hours before measurement (b) Duration: 250 hours
6	Thermal impact	(a) +70°C for 30 minutes ⇒ -25°C for 30 minutes repeated 3 times (b) Wait 4 hours before measurement

Requirements: The SAW filter shall remain within the electrical specifications after tests.

Remarks

- SAW devices should not be used in any type of fluid such as water, oil, organic solvent, etc.
- Be certain not to apply voltage exceeding the rated voltage of components.
- Do not operate outside the recommended operating temperature range of components.
- Sudden change of temperature shall be avoided, deterioration of the characteristics can occur.
- Be careful of soldering temperature and duration of components when soldering.
- Do not place soldering iron on the body of components.
- Be careful not to subject the terminals or leads of components to excessive force.

- SAW devices are electrostatic sensitive. Please avoid static voltage during operation and storage.
- Ultrasonic cleaning shall be avoided. Ultrasonic vibration may cause destruction of components.

Test Circuit

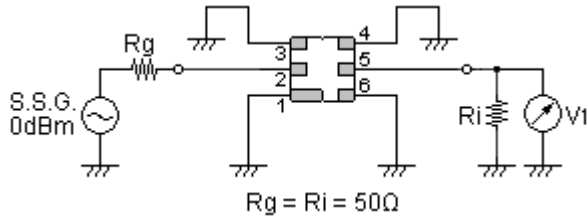

Recommended Land Pattern

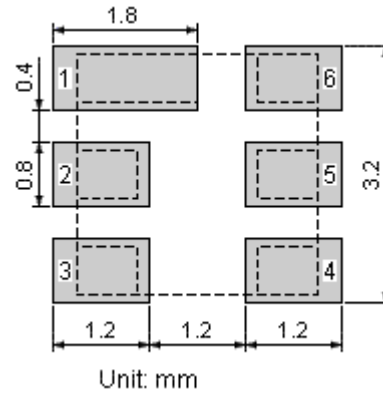

Recommended Soldering Profile

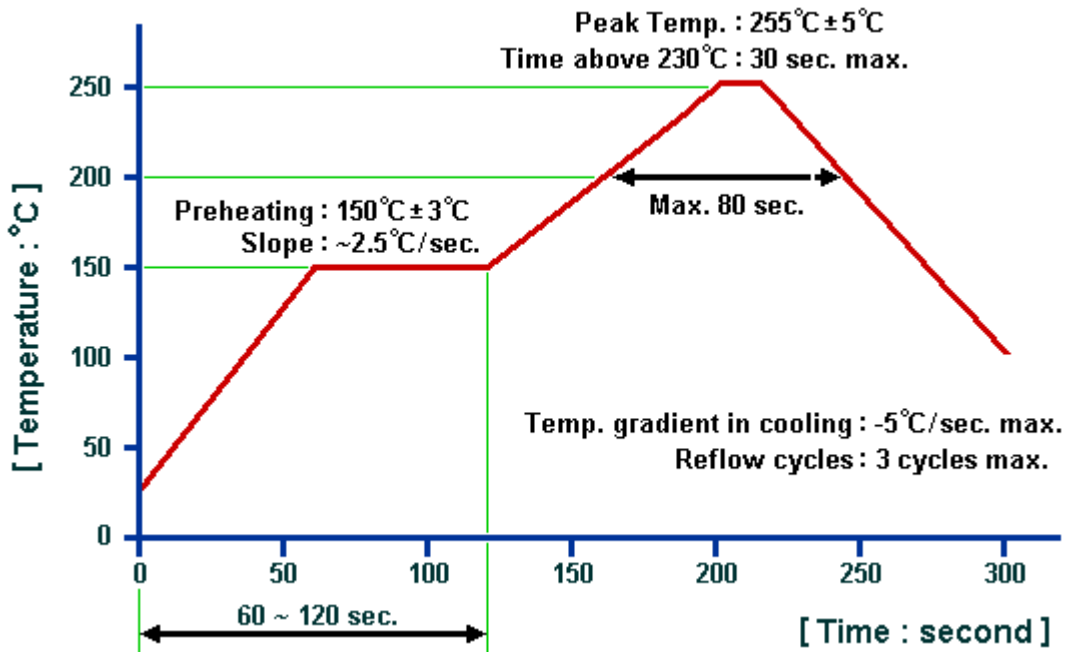

Packing Information

Carrier Tape

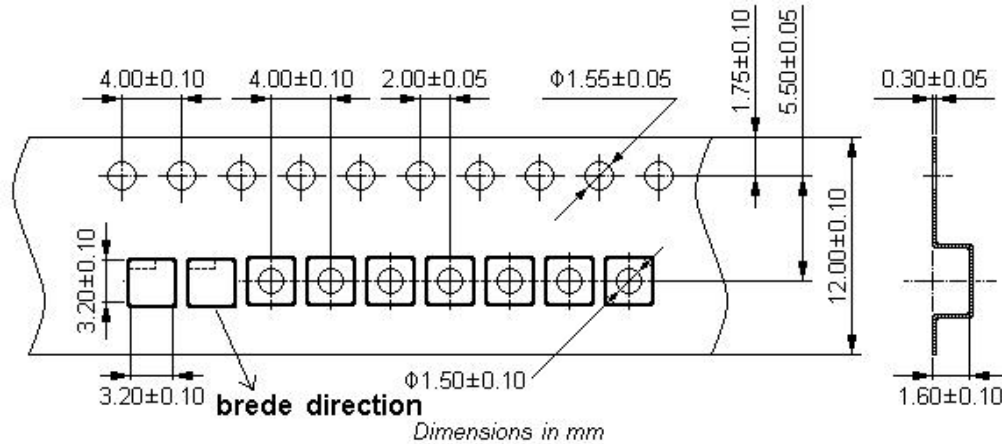

Reel Dimensions

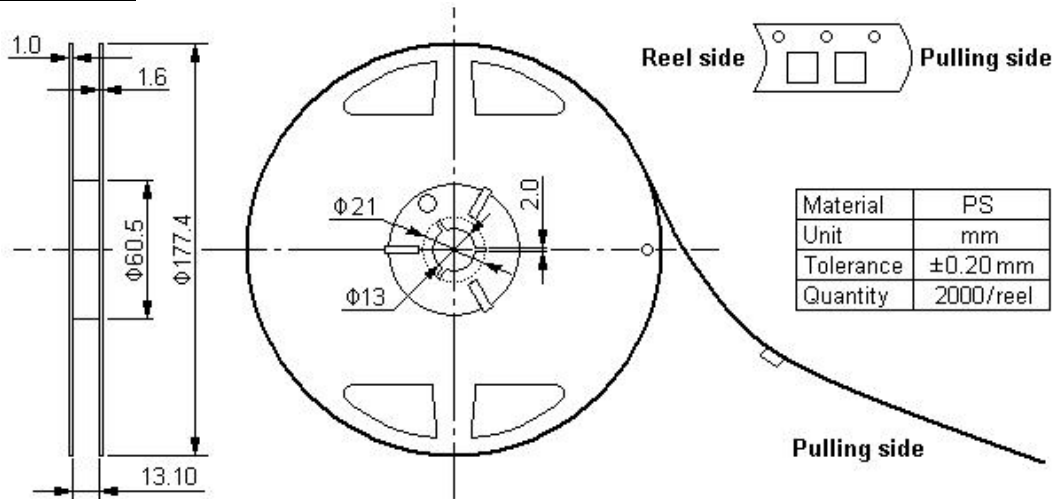

Outer Packing

Type	Quantity	Dimension	Description	Weight
Carton Box I	10000	190×190×95	anti-static plastic bag & carton box 1 reel / bag	0.85
Carton Box II	20000	190×190×190	5 bags / box (10000 pcs) 10 bags / box (20000 pcs)	1.80

Unit: mm

Unit: kg

© ACT 2011. All Rights Reserved.

1. The specifications of this device are subject to change or obsolescence without notice.
2. Typically, equipment utilizing this device requires emissions testing and government approval, which is the responsibility of the equipment manufacturer.
3. Our liability is only assumed for the Surface Acoustic Wave (SAW) component(s) per se, not for applications, processes and circuits implemented within components or assemblies.