



ULB124

NPN SILICON TRANSISTOR

NPN EPITAXIAL PLANAR TRANSISTOR

DESCRIPTION

The UTC **ULB124** is designed for high voltage, high speed switching inductive circuits, and amplifier applications.

FEATURES

- * High Speed Switching
- * Low Saturation Voltage
- * High Reliability

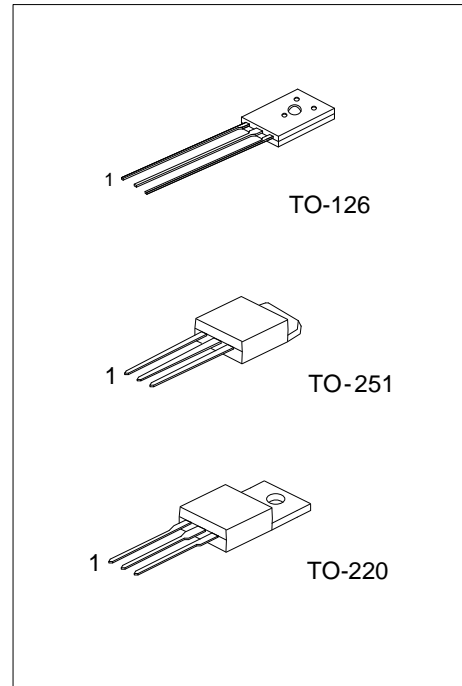

ORDERING INFORMATION

Ordering Number		Package	Pin Assignment			Packing
Lead Free	Halogen Free		1	2	3	
ULB124L-xx-TA3-T	ULB124G-xx-TA3-T	TO-220	B	C	E	Tube
ULB124L-xx-TM3-T	ULB124G-xx-TM3-T	TO-251	B	C	E	Tube
ULB124L-xx-T60-K	ULB124G-xx-T60-K	TO-126	B	C	E	Bulk

<p>ULB124L-xx-TA3-T</p> <p>(1) Packing Type (2) Package Type (3) Rank (4) Lead Free</p>	<p>(1) T: Tube (2) TA3: TO-220, TM3: TO-251, T60: TO-126 (3) xx: refer to Classification of h_{FE1} (4) L: Lead Free, G: Halogen Free</p>
---	--

■ ABSOLUTE MAXIMUM RATING (T_A=25°C)

PARAMETER		SYMBOL	RATINGS	UNIT
Collector-Base Voltage		V _{CBO}	600	V
Collector-Emitter Voltage		V _{CEO}	400	V
Emitter-Base Voltage		V _{EBO}	8	V
Collector Current	DC	I _C	2	A
	Pulse		4	A
Base Current	DC	I _B	1	A
	Pulse		2	A
Power Dissipation (T _C =25°C)	TO-220	P _D	35	W
	TO-251		20	
	TO-126		1.4	
Junction Temperature		T _J	150	°C
Storage Temperature		T _{STG}	-40 ~ +150	°C

Note: Absolute maximum ratings are those values beyond which the device could be permanently damaged. Absolute maximum ratings are stress ratings only and functional device operation is not implied.

■ ELECTRICAL CHARACTERISTICS (T_A=25°C, unless otherwise specified.)

PARAMETER	SYMBOL	TEST CONDITIONS	MIN	TYP	MAX	UNIT
OFF CHARACTERISTICS						
Collector-Base Breakdown Voltage	BV _{CBO}	I _C =1mA	600			V
Collector-Emitter Breakdown Voltage	BV _{CEO}	I _C =10mA	400			V
Emitter-Base Breakdown Voltage	BV _{EBO}	I _E =1mA	8			V
Collector Cutoff Current	I _{CBO}	V _{CB} =600V			10	μA
Emitter Cutoff Current	I _{EBO}	V _{EB} =9V, I _C =0			10	μA
ON CHARACTERISTICS						
DC Current Gain(Note)	h _{FE1}	V _{CE} = 5V, I _C =0.3A	10		40	
	h _{FE2}	V _{CE} = 5V, I _C =0.5A	10			
	h _{FE3}	V _{CE} = 5V, I _C =1A	6			
Collector-Emitter Saturation Voltage (Note)	V _{CE(SAT)}	I _C =0.1A, I _B =10mA			0.3	V
		I _C =0.3A, I _B =30mA			0.8	V
Base-Emitter Saturation Voltage (Note)	V _{BE(SAT)}	I _C =0.1A, I _B =10mA			0.9	V
		I _C =0.3A, I _B =30mA			1.2	V
SWITCHING CHARACTERISTICS						
Gain-Bandwidth Product	f _T	V _{CE} =10V, I _C =0.3A, f=1MHz	15			MHz

Note: Pulse Test : Pulse Width ≤ 380μs, Duty Cycle ≤ 2%

■ CLASSIFICATION OF h_{FE1}

RANK	B1	B2	B3	B4	B5	B6
Range	10 ~ 17	13 ~ 22	18 ~ 27	23 ~ 32	28 ~ 37	33 ~ 40

TYPICAL CHARACTERISTICS

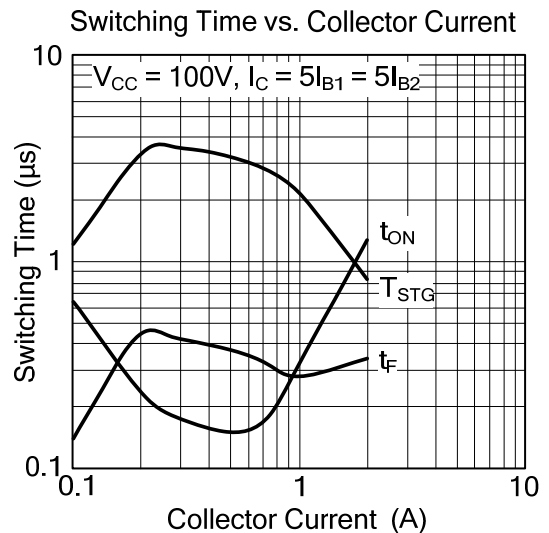
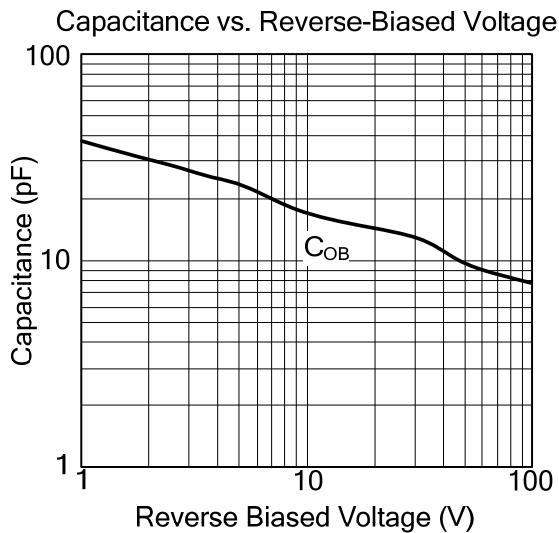
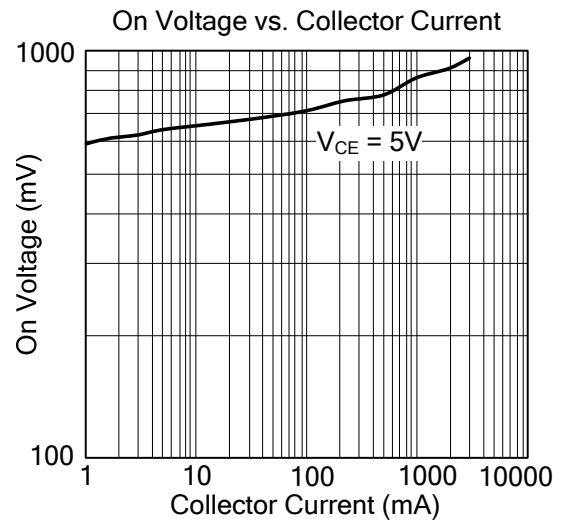
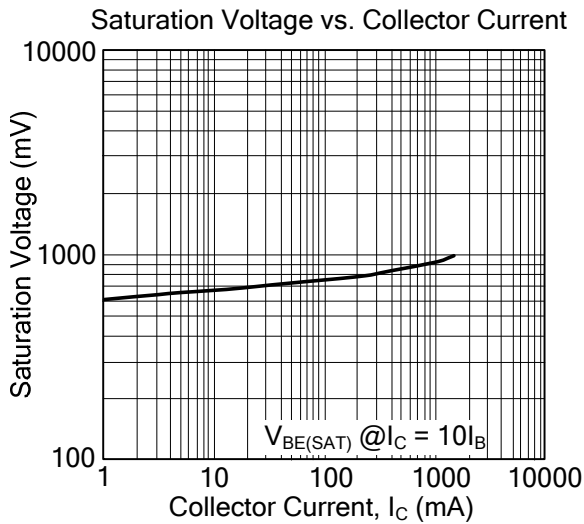
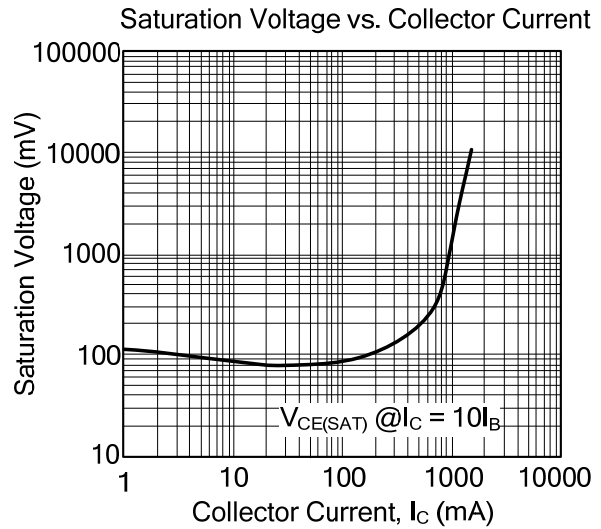
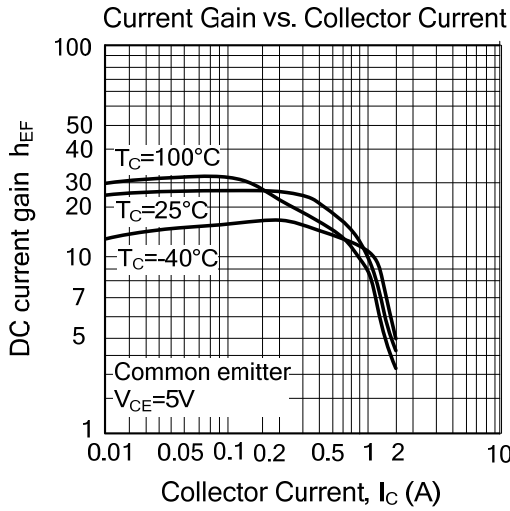

■ TYPICAL CHARACTERISTICS(Cont.)

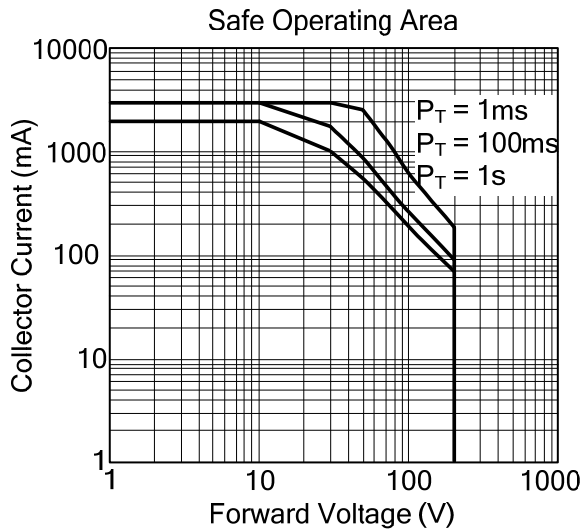

UTC assumes no responsibility for equipment failures that result from using products at values that exceed, even momentarily, rated values (such as maximum ratings, operating condition ranges, or other parameters) listed in products specifications of any and all UTC products described or contained herein. UTC products are not designed for use in life support appliances, devices or systems where malfunction of these products can be reasonably expected to result in personal injury. Reproduction in whole or in part is prohibited without the prior written consent of the copyright owner. The information presented in this document does not form part of any quotation or contract, is believed to be accurate and reliable and may be changed without notice.