



IMF18-12NNSNC0S

IMF

INDUCTIVE PROXIMITY SENSORS

SICK
Sensor Intelligence.



Ordering information

| Type | Part no. |
|-----------------|----------|
| IMF18-12NNSNCOS | 1076668 |

Other models and accessories → www.sick.com/IMF

Illustration may differ



Detailed technical data

Features

| | |
|---|---|
| Housing | Cylindrical thread design |
| Housing | Standard |
| Thread size | M18 1 |
| Diameter | Ø 18 mm |
| Sensing range S_n | 12 mm |
| Safe sensing range S_a | 9.72 mm |
| Installation type | Non-flush |
| Switching frequency | 1,000 Hz |
| Connection type | Male connector M12, 4-pin ¹⁾ |
| Switching output | NPN |
| Output function | NO |
| Electrical wiring | DC 3-wire |
| Enclosure rating | IP68 ²⁾ IP69K ³⁾ |
| Special features | Suitable for use in the food industry, Resistant to cleaning agents |

¹⁾ With gold plated contact pins.

²⁾ According to EN 60529.

³⁾ According to ISO 20653:2013-03.

Mechanics/electronics

| | |
|----------------------------|-----------------------|
| Supply voltage | 10 V DC ... 30 V DC |
| Ripple | ≤ 10 % |
| Voltage drop | ≤ 2 V ¹⁾ |
| Current consumption | ≤ 10 mA ²⁾ |

¹⁾ At I_a max.

²⁾ Without load.

³⁾ U_b and T_a constant.

⁴⁾ Of S_r.

⁵⁾ Reference voltage DC 50 V.

| | |
|---|--|
| Hysteresis | 3 % ... 20 % |
| Reproducibility | ≤ 2 % ^{3) 4)} |
| Temperature drift (of S_r) | ± 10 % |
| EMC | According to EN 60947-5-2 |
| Continuous current I_a | ≤ 200 mA |
| Short-circuit protection | ✓ |
| Reverse polarity protection | ✓ |
| Power-up pulse protection | ✓ |
| Shock and vibration resistance | 100 g / 2 ms / 500 cycles; 150 g / 1 Mio cycles; 10 Hz ... 55 Hz / 1 mm; 55 Hz ... 500 Hz / 60 g |
| Ambient operating temperature | -40 °C ... +100 °C |
| Housing material | Stainless steel, V4A (1.4404, AISI 316L) |
| Sensing face material | Plastic, LCP (FDA certified) |
| Housing length | 65 mm |
| Thread length | 39 mm |
| Tightening torque, max. | Typ. 90 Nm |
| Protection class | II ⁵⁾ |
| UL File No. | E181493 |

1) At I_a max.

2) Without load.

3) U_b and T_a constant.

4) Of S_r.

5) Reference voltage DC 50 V.

Reduction factors

| | |
|-----------------------------------|--|
| Note | The values are reference values which may vary |
| Stainless steel (V2A, 304) | Approx. 0.7 |
| Aluminum (Al) | Approx. 0.43 |
| Copper (Cu) | Approx. 0.37 |
| Brass (Br) | Approx. 0.43 |

Installation note

| | |
|---------------|---------------------------------------|
| Remark | Associated graphic see "Installation" |
| A | 18 mm |
| B | 45 mm |
| C | 18 mm |
| D | 36 mm |
| E | 12 mm |
| F | 96 mm |

Classifications

| | |
|---------------------|----------|
| ECl@ss 5.0 | 27270101 |
| ECl@ss 5.1.4 | 27270101 |
| ECl@ss 6.0 | 27270101 |
| ECl@ss 6.2 | 27270101 |

| | |
|-----------------------|----------|
| ECl@ss 7.0 | 27270101 |
| ECl@ss 8.0 | 27270101 |
| ECl@ss 8.1 | 27270101 |
| ECl@ss 9.0 | 27270101 |
| ETIM 5.0 | EC002714 |
| ETIM 6.0 | EC002714 |
| UNSPSC 16.0901 | 39122230 |

Installation note

Non-flush installation

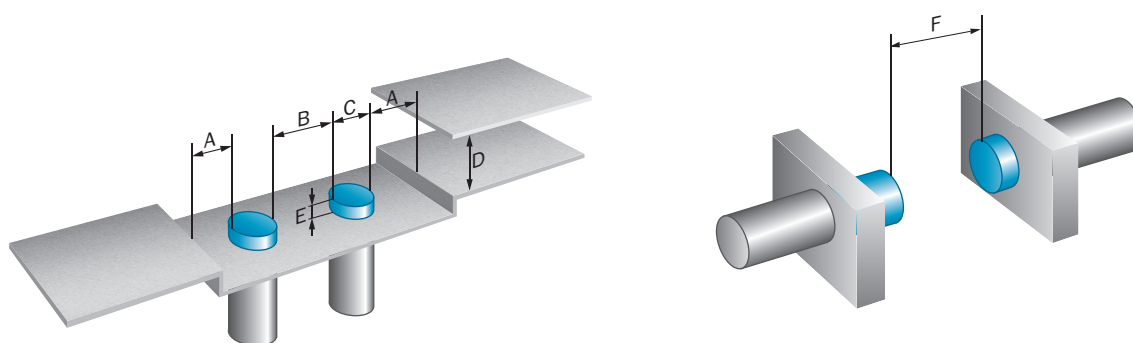

Adjustments possible

Normally open

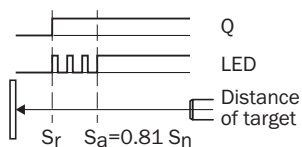

Connection diagram

cd-007

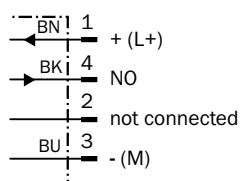

Characteristic curve

Non-flush installation

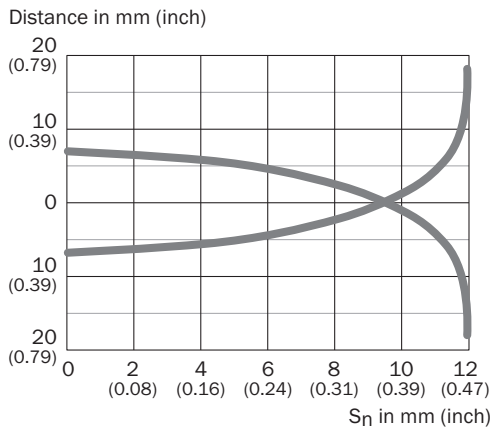

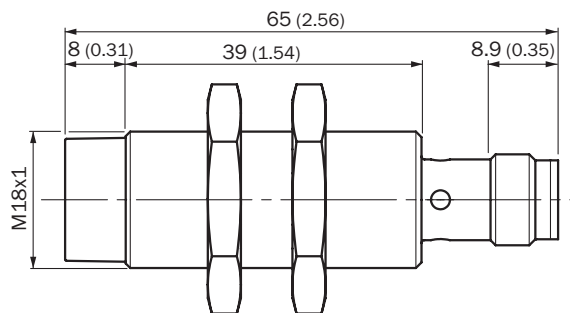

Dimensional drawing (Dimensions in mm (inch))

IMF18, non flush



Recommended accessories

Other models and accessories → www.sick.com/IMF

| | Brief description | Type | Part no. |
|---|---|--------------|----------|
| Universal bar clamp systems | | | |
|  | Plate N06N for universal clamp bracket, M18, Stainless steel 1.4571 (sheet), Stainless steel 1.4408 (clamp), Universal clamp (5322627), mounting hardware | BEF-KHS-N06N | 2051622 |
| Mounting brackets and plates | | | |
|  | Mounting plate for M18 sensors, stainless steel, without mounting hardware | BEF-WG-M18N | 5320948 |
|  | Mounting bracket for M18 sensors, stainless steel, without mounting hardware | BEF-WN-M18N | 5320947 |

| | Brief description | Type | Part no. |
|---|---|-----------------|-----------------|
| Plug connectors and cables | | | |
|  | <p>Head A: female connector, M12, 4-pin, straight Head B: open cable ends Cable: PP, unshielded, 2 m This product is generally resistant to chemical cleaning agents (see ECOLAB) and other chemical compounds such as H2O2 and CH2O2. Before permanent installation is carried out, the material's resistance to the cleaning agent being used must be checked.</p> | DOL-1204-G02MRN | 6058291 |
| | <p>Head A: female connector, M12, 4-pin, straight Head B: open cable ends Cable: PP, unshielded, 5 m This product is generally resistant to chemical cleaning agents (see ECOLAB) and other chemical compounds such as H2O2 and CH2O2. Before permanent installation is carried out, the material's resistance to the cleaning agent being used must be checked.</p> | DOL-1204-G05MRN | 6058476 |
|  | <p>Head A: female connector, M12, 4-pin, angled with LED Head B: open cable ends Cable: PP, unshielded, 2 m This product is generally resistant to chemical cleaning agents (see ECOLAB) and other chemical compounds such as H2O2 and CH2O2. Before permanent installation is carried out, the material's resistance to the cleaning agent being used must be checked.</p> | DOL-1204-L02MRN | 6058482 |
| | <p>Head A: female connector, M12, 4-pin, angled with LED Head B: open cable ends Cable: PP, unshielded, 5 m This product is generally resistant to chemical cleaning agents (see ECOLAB) and other chemical compounds such as H2O2 and CH2O2. Before permanent installation is carried out, the material's resistance to the cleaning agent being used must be checked.</p> | DOL-1204-L05MRN | 6058483 |
|  | <p>Head A: female connector, M12, 4-pin, angled Head B: open cable ends Cable: PP, unshielded, 2 m This product is generally resistant to chemical cleaning agents (see ECOLAB) and other chemical compounds such as H2O2 and CH2O2. Before permanent installation is carried out, the material's resistance to the cleaning agent being used must be checked.</p> | DOL-1204-W02MRN | 6058474 |
| | <p>Head A: female connector, M12, 4-pin, angled Head B: open cable ends Cable: PP, unshielded, 5 m This product is generally resistant to chemical cleaning agents (see ECOLAB) and other chemical compounds such as H2O2 and CH2O2. Before permanent installation is carried out, the material's resistance to the cleaning agent being used must be checked.</p> | DOL-1204-W05MRN | 6058477 |
|  | <p>Head A: female connector, M12, 4-pin, angled Head B: male connector, M12, 4-pin, straight Cable: PP, unshielded, 2 m This product is generally resistant to chemical cleaning agents (see ECOLAB) and other chemical compounds such as H2O2 and CH2O2. Before permanent installation is carried out, the material's resistance to the cleaning agent being used must be checked.</p> | DSL-1204-B02MRN | 6058502 |
| | <p>Head A: female connector, M12, 4-pin, angled Head B: male connector, M12, 4-pin, straight Cable: PP, unshielded, 5 m This product is generally resistant to chemical cleaning agents (see ECOLAB) and other chemical compounds such as H2O2 and CH2O2. Before permanent installation is carried out, the material's resistance to the cleaning agent being used must be checked.</p> | DSL-1204-B05MRN | 6058503 |
|  | <p>Head A: female connector, M12, 4-pin, straight Head B: male connector, M12, 4-pin, straight Cable: PP, unshielded, 2 m This product is generally resistant to chemical cleaning agents (see ECOLAB) and other chemical compounds such as H2O2 and CH2O2. Before permanent installation is carried out, the material's resistance to the cleaning agent being used must be checked.</p> | DSL-1204-G02MRN | 6058499 |
| | <p>Head A: female connector, M12, 4-pin, straight Head B: male connector, M12, 4-pin, straight Cable: PP, unshielded, 5 m This product is generally resistant to chemical cleaning agents (see ECOLAB) and other chemical compounds such as H2O2 and CH2O2. Before permanent installation is carried out, the material's resistance to the cleaning agent being used must be checked.</p> | DSL-1204-G05MRN | 6058500 |

SICK AT A GLANCE

SICK is one of the leading manufacturers of intelligent sensors and sensor solutions for industrial applications. A unique range of products and services creates the perfect basis for controlling processes securely and efficiently, protecting individuals from accidents and preventing damage to the environment.

We have extensive experience in a wide range of industries and understand their processes and requirements. With intelligent sensors, we can deliver exactly what our customers need. In application centers in Europe, Asia and North America, system solutions are tested and optimized in accordance with customer specifications. All this makes us a reliable supplier and development partner.

Comprehensive services complete our offering: SICK LifeTime Services provide support throughout the machine life cycle and ensure safety and productivity.

For us, that is “Sensor Intelligence.”

WORLDWIDE PRESENCE:

Contacts and other locations www.sick.com