

MITSUBISHI IGBT MODULES  
**CM75DY-12H**  
 HIGH POWER SWITCHING USE  
 INSULATED TYPE

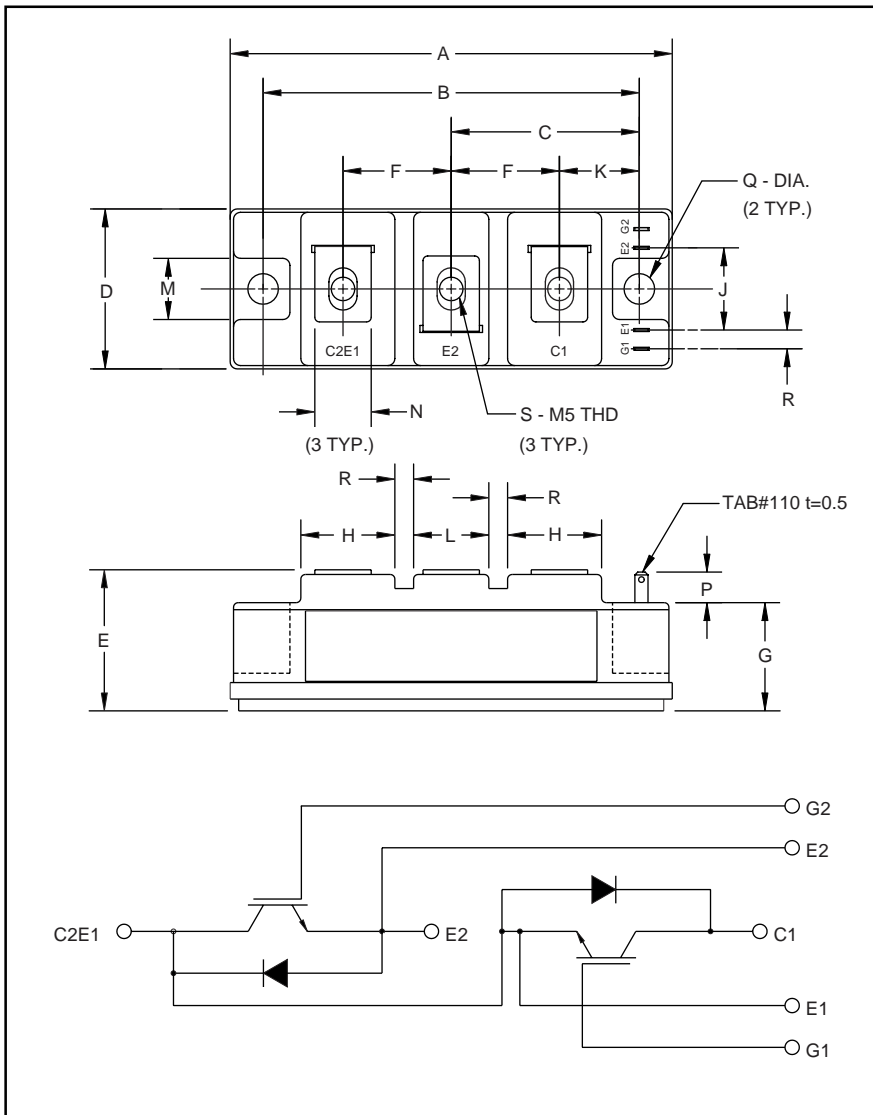

**Description:**

Mitsubishi IGBT Modules are designed for use in switching applications. Each module consists of two IGBTs in a half-bridge configuration with each transistor having a reverse-connected super-fast recovery free-wheel diode. All components and interconnects are isolated from the heat sinking baseplate, offering simplified system assembly and thermal management.

**Features:**

- Low Drive Power
- Low  $V_{CE(sat)}$
- Discrete Super-Fast Recovery Free-Wheel Diode
- High Frequency Operation
- Isolated Baseplate for Easy Heat Sinking

**Applications:**

- AC Motor Control
- Motion/Servo Control
- UPS
- Welding Power Supplies

**Ordering Information:**

Example: Select the complete part module number you desire from the table below -i.e. CM75DY-12H is a 600V ( $V_{CES}$ ), 75 Ampere Dual IGBT Module.

Type	Current Rating Amperes	$V_{CES}$ Volts (x 50)
CM	75	12

**Outline Drawing and Circuit Diagram**

Dimensions	Inches	Millimeters
A	3.70	94.0
B	3.150±0.01	80.0±0.25
C	1.57	40.0
D	1.34	34.0
E	1.22 Max.	31.0 Max.
F	0.90	23.0
G	0.85	21.5
H	0.79	20.0
J	0.71	18.0

Dimensions	Inches	Millimeters
K	0.67	17.0
L	0.63	16.0
M	0.51	13.0
N	0.47	12.0
P	0.28	7.0
Q	0.256 Dia.	Dia. 6.5
R	0.16	4.0
S	M5 Metric	M5

# CM75DY-12H

HIGH POWER SWITCHING USE  
INSULATED TYPE

## Absolute Maximum Ratings, $T_j = 25\text{ }^\circ\text{C}$ unless otherwise specified

Ratings	Symbol	CM75DY-12H	Units
Junction Temperature	$T_j$	-40 to 150	$^\circ\text{C}$
Storage Temperature	$T_{stg}$	-40 to 125	$^\circ\text{C}$
Collector-Emitter Voltage (G-E SHORT)	$V_{CES}$	600	Volts
Gate-Emitter Voltage (C-E SHORT)	$V_{GES}$	$\pm 20$	Volts
Collector Current ( $T_C = 25\text{ }^\circ\text{C}$ )	$I_C$	75	Amperes
Peak Collector Current	$I_{CM}$	150*	Amperes
Emitter Current** ( $T_C = 25\text{ }^\circ\text{C}$ )	$I_E$	75	Amperes
Peak Emitter Current**	$I_{EM}$	150*	Amperes
Maximum Collector Dissipation ( $T_C = 25\text{ }^\circ\text{C}$ , $T_j \leq 150\text{ }^\circ\text{C}$ )	$P_c$	310	Watts
Mounting Torque, M5 Main Terminal	-	1.47 ~ 1.96	N · m
Mounting Torque, M6 Mounting	-	1.96 ~ 2.94	N · m
Weight	-	190	Grams
Isolation Voltage (Main Terminal to Baseplate, AC 1 min.)	$V_{iso}$	2500	Vrms

\*Pulse width and repetition rate should be such that the device junction temperature ( $T_j$ ) does not exceed  $T_{j(max)}$  rating.

\*\*Represents characteristics of the anti-parallel, emitter-to-collector free-wheel diode (FWDi).

## Static Electrical Characteristics, $T_j = 25\text{ }^\circ\text{C}$ unless otherwise specified

Characteristics	Symbol	Test Conditions	Min.	Typ.	Max.	Units
Collector-Cutoff Current	$I_{CES}$	$V_{CE} = V_{CES}$ , $V_{GE} = 0V$	-	-	1.0	mA
Gate Leakage Current	$I_{GES}$	$V_{GE} = V_{GES}$ , $V_{CE} = 0V$	-	-	0.5	$\mu\text{A}$
Gate-Emitter Threshold Voltage	$V_{GE(th)}$	$I_C = 7.5\text{mA}$ , $V_{CE} = 10V$	4.5	6.0	7.5	Volts
Collector-Emitter Saturation Voltage	$V_{CE(sat)}$	$I_C = 75A$ , $V_{GE} = 15V$	-	2.1	2.8**	Volts
		$I_C = 75A$ , $V_{GE} = 15V$ , $T_j = 150\text{ }^\circ\text{C}$	-	2.15	-	Volts
Total Gate Charge	$Q_G$	$V_{CC} = 300V$ , $I_C = 75A$ , $V_{GE} = 15V$	-	225	-	nC
Emitter-Collector Voltage	$V_{EC}$	$I_E = 75A$ , $V_{GE} = 0V$	-	-	2.8	Volts

\*\* Pulse width and repetition rate should be such that device junction temperature rise is negligible.

## Dynamic Electrical Characteristics, $T_j = 25\text{ }^\circ\text{C}$ unless otherwise specified

Characteristics	Symbol	Test Conditions	Min.	Typ.	Max.	Units	
Input Capacitance	$C_{ies}$		-	-	7.5	nF	
Output Capacitance	$C_{oes}$	$V_{GE} = 0V$ , $V_{CE} = 10V$	-	-	2.6	nF	
Reverse Transfer Capacitance	$C_{res}$		-	-	1.5	nF	
Resistive	Turn-on Delay Time	$V_{CC} = 300V$ , $I_C = 75A$ , $V_{GE1} = V_{GE2} = 15V$ , $R_G = 8.3\Omega$	-	-	120	ns	
Load	Rise Time						$t_{d(on)}$
Switching	Turn-off Delay Time						$t_r$
Times	Fall Time						$t_{d(off)}$
Diode Reverse Recovery Time	$t_{rr}$	$I_E = 75A$ , $di_E/dt = -150A/\mu\text{s}$	-	-	110	ns	
Diode Reverse Recovery Charge	$Q_{rr}$	$I_E = 75A$ , $di_E/dt = -150A/\mu\text{s}$	-	0.2	-	$\mu\text{C}$	

## Thermal and Mechanical Characteristics, $T_j = 25\text{ }^\circ\text{C}$ unless otherwise specified

Characteristics	Symbol	Test Conditions	Min.	Typ.	Max.	Units
Thermal Resistance, Junction to Case	$R_{th(j-c)}$	Per IGBT	-	-	0.40	$^\circ\text{C/W}$
Thermal Resistance, Junction to Case	$R_{th(j-c)}$	Per FWDi	-	-	0.90	$^\circ\text{C/W}$
Contact Thermal Resistance	$R_{th(c-f)}$	Per Module, Thermal Grease Applied	-	-	0.075	$^\circ\text{C/W}$

# CM75DY-12H

HIGH POWER SWITCHING USE  
INSULATED TYPE

**OUTPUT CHARACTERISTICS (TYPICAL)**

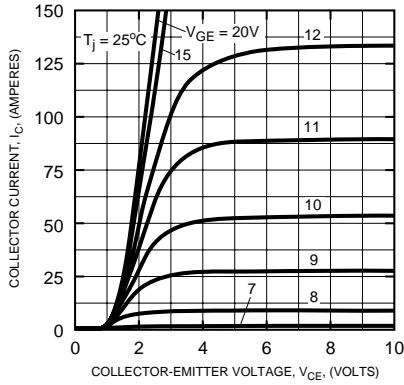

**TRANSFER CHARACTERISTICS (TYPICAL)**

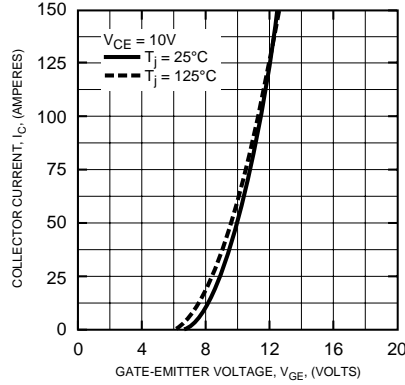

**COLLECTOR-EMITTER SATURATION VOLTAGE CHARACTERISTICS (TYPICAL)**

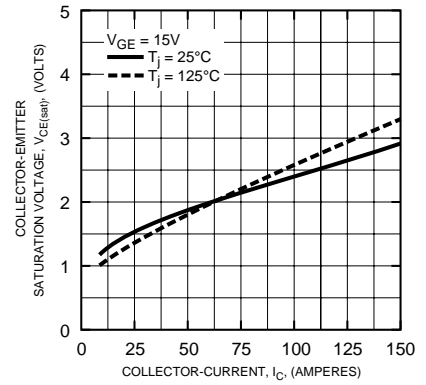

**COLLECTOR-EMITTER SATURATION VOLTAGE CHARACTERISTICS (TYPICAL)**

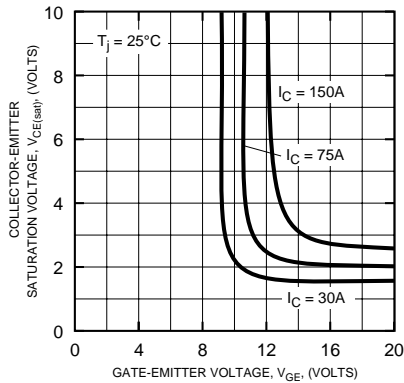

**FREE-WHEEL DIODE FORWARD CHARACTERISTICS (TYPICAL)**

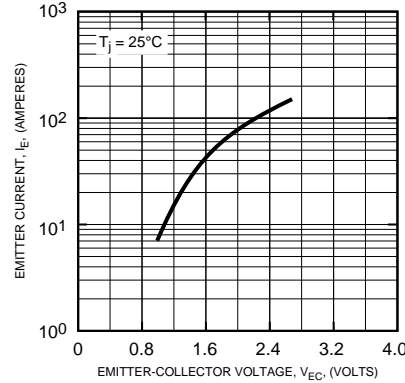

**CAPACITANCE VS. VCE (TYPICAL)**

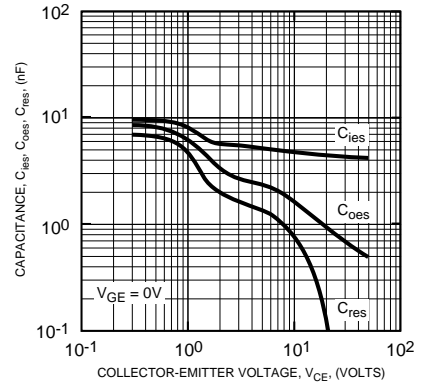

**HALF-BRIDGE SWITCHING CHARACTERISTICS (TYPICAL)**

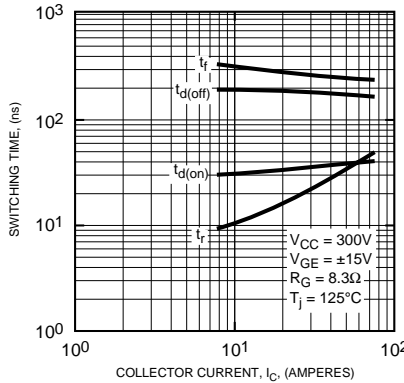

**REVERSE RECOVERY CHARACTERISTICS (TYPICAL)**

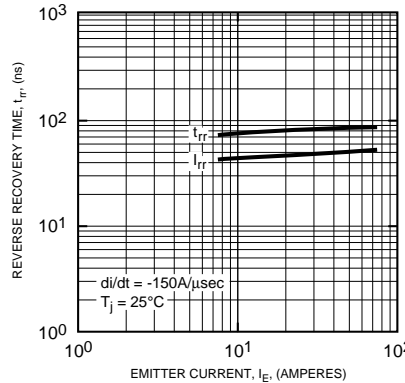

**GATE CHARGE, VGE**

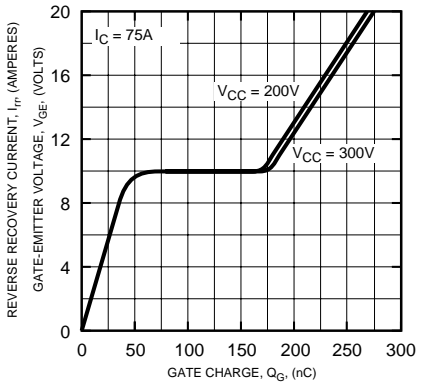

# CM75DY-12H

HIGH POWER SWITCHING USE  
INSULATED TYPE

