

# SMG5C60F

Thyristor **SMG5C60F** is designed for full wave AC control applications. It can be used as an ON/OFF function or for phase control operation.

### Typical Applications

- Home Appliances : Electric Blankets, Starter for FL, other control applications
- Industrial Use : SMPS, Solenoid for Breakers, Motor Controls, Heater Controls, other control applications

### Features

- $I_{T(AV)}=5A$
- High Surge Current
- Low Voltage Drop
- Lead-Free Package

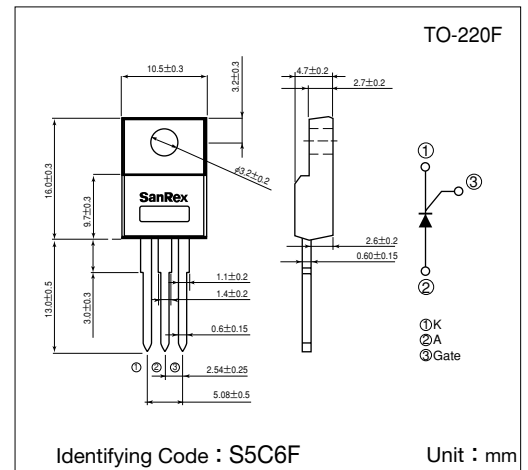

### Maximum Ratings

( $T_j=25^{\circ}C$  unless otherwise specified)

Symbol	Item	Reference	Ratings	Unit
$V_{RRM}$	Repetitive Peak Reverse Voltage		600	V
$V_{RSM}$	Non-Repetitive Peak Reverse Voltage		720	V
$V_{DRM}$	Repetitive Peak Off-State Voltage		600	V
$I_{T(AV)}$	Average On-State Current	Single phase, half wave, $180^{\circ}$ , conduction, $T_c=96^{\circ}C$	5	A
$I_{T(RMS)}$	R.M.S. On-State Current	Single phase, half wave, $180^{\circ}$ , conduction, $T_c=96^{\circ}C$	7.8	A
$I_{TSM}$	Surge On-State Current	50Hz/60Hz, $\frac{1}{2}$ cycle Peak value, non-repetitive	80/88	A
$I^2t$	$I^2t$		32	A <sup>2</sup> S
$P_{GM}$	Peak Gate Power Dissipation		5	W
$P_{G(AV)}$	Average Gate Power Dissipation		0.5	W
$I_{FGM}$	Peak Gate Current		2	A
$V_{FGM}$	Peak Gate Voltage (Forward)		6	V
$V_{RGM}$	Peak Gate Voltage (Reverse)		10	V
$V_{ISO}$	Isolation Breakdown (R.M.S.)	A.C 1minute	1500	V
$T_j$	Operating Junction Temperature		$-40 \sim +125$	$^{\circ}C$
$T_{stg}$	Storage Temperature		$-40 \sim +150$	$^{\circ}C$
	Mass		2	g

### Electrical Characteristics

Symbol	Item	Reference	Ratings			Unit
			Min.	Typ.	Max.	
$I_{DRM}$	Repetitive Peak Off-State Current	$T_j=125^{\circ}C, V_D=V_{DRM}$			2	mA
$I_{RRM}$	Repetitive Peak Reverse Current	$T_j=125^{\circ}C, V_R=V_{RRM}$			2	mA
$V_{TM}$	Peak On-State Voltage	$I_T=15A$ , Inst. measurement			1.5	V
$I_{GT}$	Gate Trigger Current	$V_D=6V, R_L=10\Omega$			10	mA
$V_{GT}$	Gate Trigger Voltage				1.4	V
$V_{GD}$	Non-Trigger Gate Voltage	$T_j=125^{\circ}C, V_D=\frac{1}{2}V_{DRM}$	0.2			V
$I_H$	Holding Current			15		mA
$R_{th(j-c)}$	Thermal Resistance	Junction to case			4	$^{\circ}C/W$

Gate Characteristics

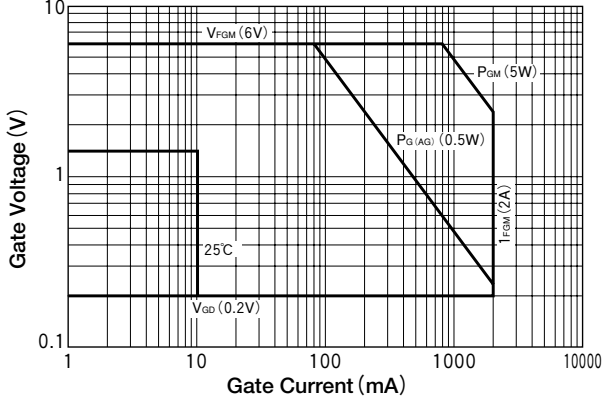

On-State Voltage Max

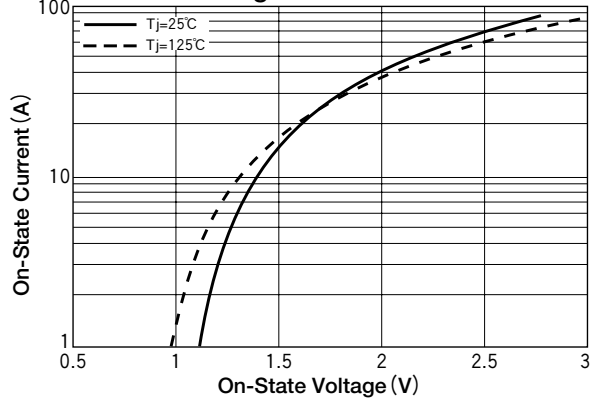

Average On-State Current vs Power Dissipation (Single phase half wave)

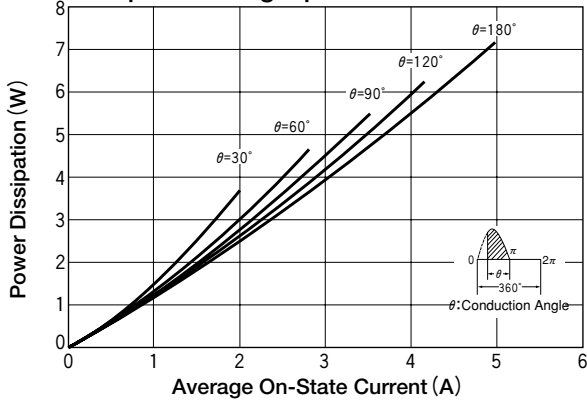

Average On-State Current vs Ambient Temperature (Single phase half wave)

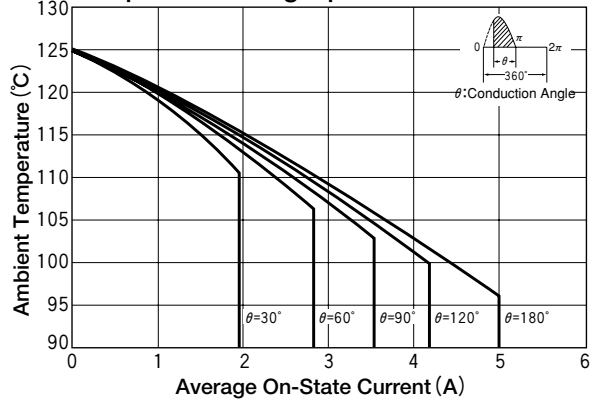

Surge On-State Current Rating (Non-Repetitive)

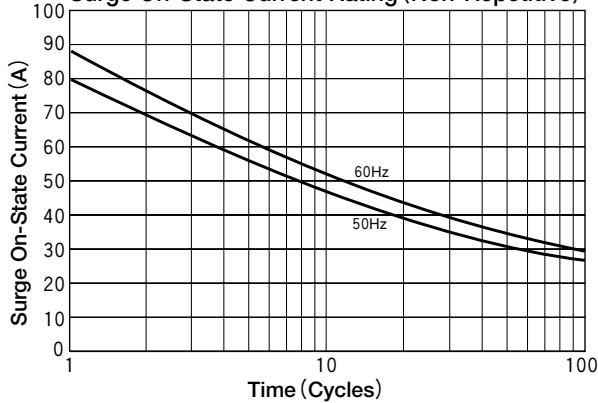

Maximum Transient Thermal Impedance Characteristics

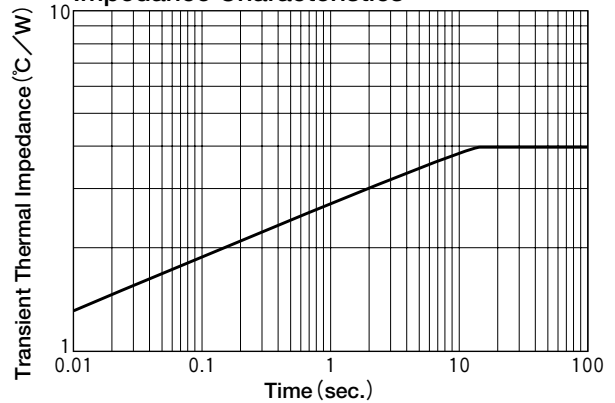

$I_{GT} - T_j$  [Change Rate] (Typical)

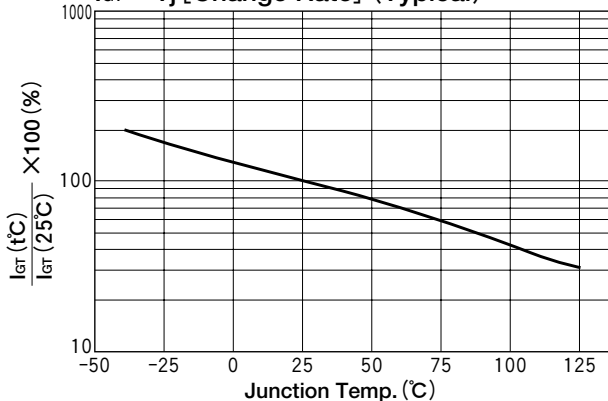

$V_{GT} - T_j$  (Typical)

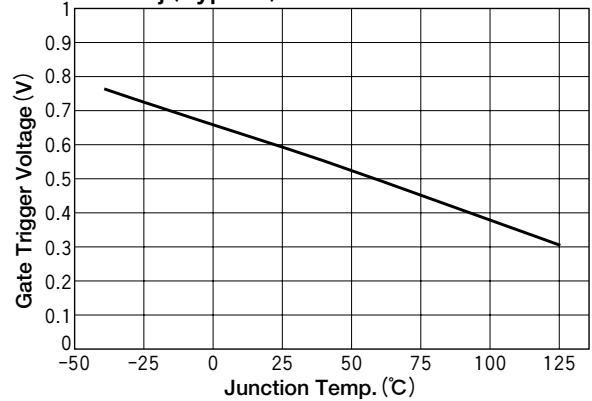

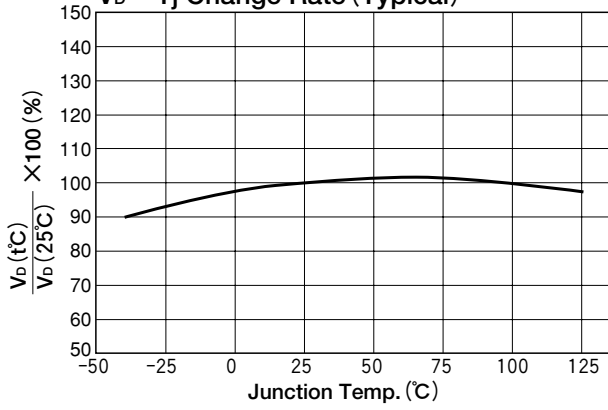
**$V_D - T_j$  Change Rate (Typical)**

 **$V_R - T_j$  Change Rate (Typical)**
