



# AL20E-PM331

Ax20

ARRAY SENSORS

**SICK**  
Sensor Intelligence.



### Ordering information

Type	Part no.
AL20E-PM331	1046462

Other models and accessories → [www.sick.com/Ax20](http://www.sick.com/Ax20)



### Detailed technical data

#### Features

<b>Functional principle</b>	Edge detection, reflector
<b>Dimensions (W x H x D)</b>	24.3 mm x 59.8 mm x 54.1 mm
<b>Sensing distance</b>	100 mm
<b>Housing design (light emission)</b>	Rectangular
<b>Working range</b>	90 mm ... 110 mm
<b>Measurement range</b>	30 mm
<b>Minimum detectable object (MDO)</b>	1.6 mm
<b>Light source</b>	LED, White
<b>Wave length</b>	400 nm ... 700 nm
<b>Light spot size</b>	50 mm x 10 mm
<b>Reproducibility</b>	0.05 mm <sup>1)</sup>
<b>Linearity</b>	± 2 % <sup>2)</sup>

<sup>1)</sup> With respect to sensing distance.

<sup>2)</sup> Analog current range (16 mA).

#### Mechanics/electronics

<b>Supply voltage</b>	≤ 24 V DC <sup>1)</sup>
<b>Ripple</b>	≤ 5 V <sup>2)</sup>
<b>Power consumption</b>	< 3.1 W <sup>3)</sup>
<b>Switching output</b>	PNP
<b>Switching output (voltage)</b>	PNP: HIGH = V <sub>S-</sub> ≤ 2 V / LOW approx. 0 V
<b>Analog output</b>	4 mA ... 20 mA
<b>Resolution of analog output</b>	12 bit

<sup>1)</sup> ± 20 %. Operation in short-circuit protected network max. 8 A.

<sup>2)</sup> May not exceed or fall below U<sub>v</sub> tolerances.

<sup>3)</sup> Without load.

<sup>4)</sup> Typ. max. 1.6 s.

<b>Output rate of analog output</b>	1 ms
<b>Output current I<sub>max.</sub></b>	< 100 mA
<b>Initialization time</b>	0.48 s <sup>4)</sup>
<b>Connection type</b>	Male connector M12, 5-pin
<b>Protection class</b>	III
<b>Circuit protection</b>	U <sub>V</sub> connections, reverse polarity protected Output Q short-circuit protected Interference pulse suppression
<b>Enclosure rating</b>	IP67
<b>Weight</b>	135 g
<b>Housing material</b>	Metal

1) ± 20 %. Operation in short-circuit protected network max. 8 A.

2) May not exceed or fall below U<sub>V</sub> tolerances.

3) Without load.

4) Typ. max. 1.6 s.

### Ambient data

<b>Ambient operating temperature</b>	-10 °C ... +55 °C
<b>Ambient storage temperature</b>	-25 °C ... +75 °C
<b>Shock load</b>	According to IEC 60068
<b>UL File No.</b>	NRKH.E181493 & NRKH7.E181493

### Classifications

<b>ECl@ss 5.0</b>	27310205
<b>ECl@ss 5.1.4</b>	27310205
<b>ECl@ss 6.0</b>	27310205
<b>ECl@ss 6.2</b>	27310205
<b>ECl@ss 7.0</b>	27310205
<b>ECl@ss 8.0</b>	27310205
<b>ECl@ss 8.1</b>	27310205
<b>ECl@ss 9.0</b>	27310205
<b>ETIM 5.0</b>	EC001825
<b>ETIM 6.0</b>	EC001825
<b>UNSPSC 16.0901</b>	43211731

### Dimensional drawing (Dimensions in mm (inch))

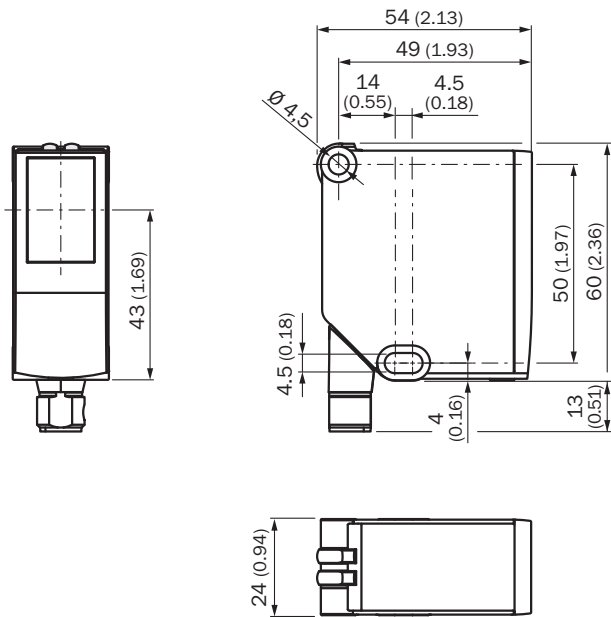

### Connection diagram

cd-315

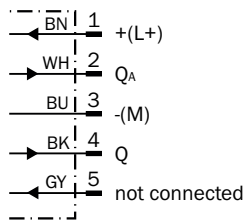

## Concept of operation

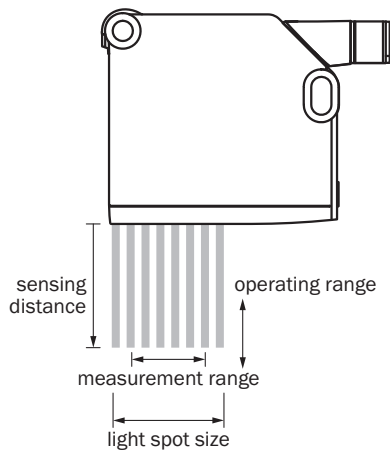

Explanation of parameters





Sensing distance	Operating range	Measurement range	Light spot size
25 mm	20 mm ... 30 mm	20 mm	30 mm x 5 mm
100 mm	90 mm ... 110 mm	30 mm	50 mm x 10 mm

## Recommended accessories

Other models and accessories → [www.sick.com/Ax20](http://www.sick.com/Ax20)

	Brief description	Type	Part no.
<b>Mounting brackets and plates</b>			
	Mounting bracket, stainless steel, without mounting material, for DT20 Hi, without mounting hardware	BEF-WN-DT20	4043524
<b>Plug connectors and cables</b>			
	Head A: female connector, M12, 5-pin, straight, A-coded Head B: Flying leads Cable: Sensor/actuator cable, PVC, unshielded, 2 m	YF2A15-020VB5XLEAX	2096239
	Head A: female connector, M12, 5-pin, straight, A-coded Head B: Flying leads Cable: Sensor/actuator cable, PVC, unshielded, 5 m	YF2A15-050VB5XLEAX	2096240
	Head A: female connector, M12, 5-pin, straight, A-coded Head B: Flying leads Cable: Sensor/actuator cable, PVC, unshielded, 10 m	YF2A15-100VB5XLEAX	2096241
	Head A: female connector, M12, 5-pin, angled, A-coded Head B: Flying leads Cable: Sensor/actuator cable, PVC, unshielded, 2 m	YG2A15-020VB5XLEAX	2096215
	Head A: female connector, M12, 5-pin, angled, A-coded Head B: Flying leads Cable: Sensor/actuator cable, PVC, unshielded, 5 m	YG2A15-050VB5XLEAX	2096216
	Head A: female connector, M12, 5-pin, angled, A-coded Head B: Flying leads Cable: Sensor/actuator cable, PVC, unshielded, 10 m	YG2A15-100VB5XLEAX	2096217

	Brief description	Type	Part no.
	Head A: female connector, M12, 5-pin, straight Cable: unshielded	DOS-1205-G	6009719
	Head A: female connector, M12, 5-pin, angled Head B: - Cable: unshielded	DOS-1205-W	6009720

## SICK AT A GLANCE

SICK is one of the leading manufacturers of intelligent sensors and sensor solutions for industrial applications. A unique range of products and services creates the perfect basis for controlling processes securely and efficiently, protecting individuals from accidents and preventing damage to the environment.

We have extensive experience in a wide range of industries and understand their processes and requirements. With intelligent sensors, we can deliver exactly what our customers need. In application centers in Europe, Asia and North America, system solutions are tested and optimized in accordance with customer specifications. All this makes us a reliable supplier and development partner.

Comprehensive services complete our offering: SICK LifeTime Services provide support throughout the machine life cycle and ensure safety and productivity.

For us, that is “Sensor Intelligence.”

## WORLDWIDE PRESENCE:

Contacts and other locations –[www.sick.com](http://www.sick.com)