



## User's Guide

# C-28-0605

# VFD

(Vacuum Fluorescent Character Display Module)

---

For product support, contact

New haven Display International  
2511 Technology Drive #101  
Elgin , IL 601 24  
Tel: (847) 8 44-8795 Fax: (847) 8 44-8796

October 31, 2006

# Vacuum Fluorescent Display Specification

**PART NUMBER:** C-28-0605

**FEATURES:** 7 Digits, Seven Segmented, with Icons – DVD

**APPLICATION:** Character Display (7-Seg)

**RATINGS:** Below

<b>Outer Dimensions</b>	Panel Length	P.L.	100.0	mm	
	Panel Height	P.H.	28.0	mm	
	Panel Thickness	P.T.	8.5	mm	
<b>Leads</b>	Lead Pitch	L.P.	2.54	Mm	
	Lead Out	-	SIL		
<b>Character Size</b>	Character Height	C.H.	Multi	mm	
	Character Width	C.W.	Multi	mm	
<b>Item</b>	<b>Symbol</b>	<b>Min.</b>	<b>Recommended</b>	<b>Max.</b>	<b>Unit</b>
<b>Filament Voltage</b>	Ef	3.2	3.5	3.9	Vac
<b>Peak Grid Voltage</b>	Ec	-	25.0	28.0	Vp-p
<b>Peak Anode Voltage</b>	Eb	-	25.0	28.0	Vp-p
<b>Cut-off Bias</b>	Ek	-	-	-	-
<b>Duty Cycle</b>	Du	-	1/9	-	-
<b>Pulse Width</b>	Tp	-	100	-	uS
<b>Operating Temperature</b>	Topr	-20	-	+ 70	C
<b>Storage Temperature</b>	Tstg	-55	-	+ 80	C
<b>Color of Illumination</b>	Green / Red / Yellow				

Electrical Characteristics



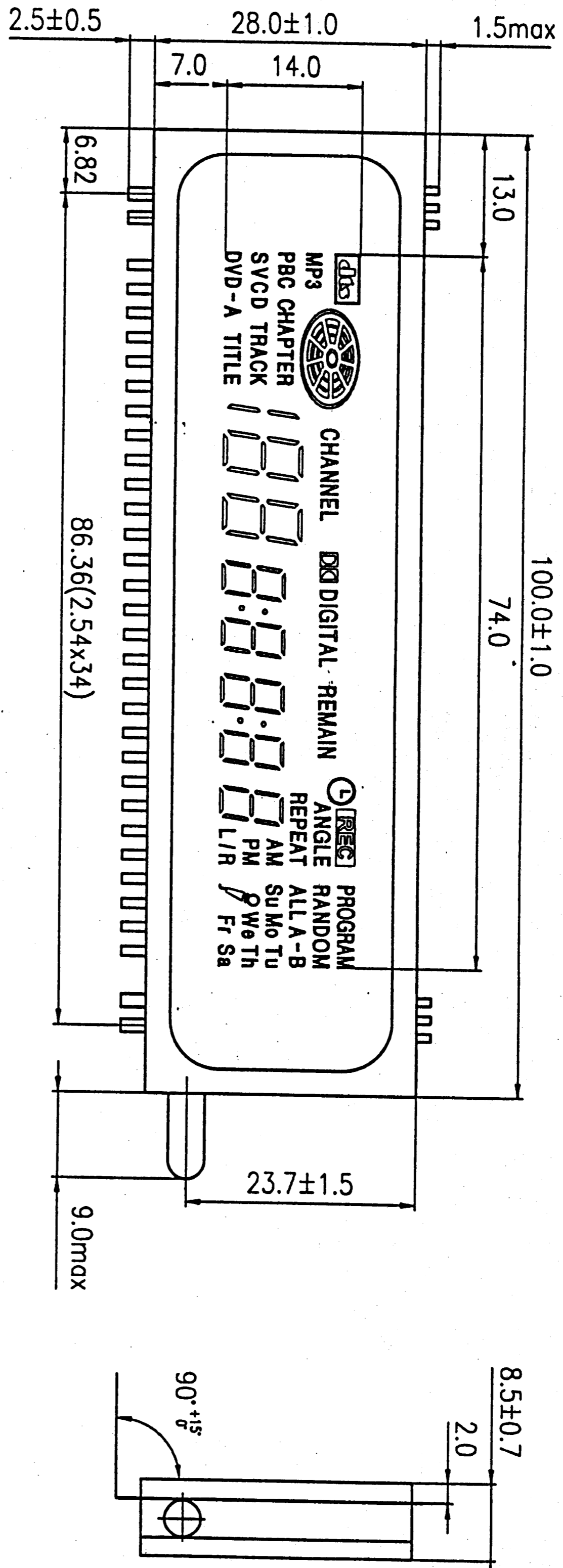

Item	Symbol	Test Condition	Min.	Typical	Max.	Unit
<b>Filament Current</b>	If -	Ef = 3.5 Vac eb = ec = 0	112.5 -	125.0 -	137.5 -	mAac -
<b>Anode Current</b>	ib/1,2,3,4G	Ef = 3.5 Vac eb = 25.0 Vp-p ec = 25.0 Vp-p Du = 1/9 tp = 100 uS	-	8.0	16.0	mA <sub>p-p</sub>
	ib/5,6G		-	10.0	20.0	mA <sub>p-p</sub>
	-		-	-	-	mA <sub>p-p</sub>
	-		-	-	-	mA <sub>p-p</sub>
	-		-	-	-	mA <sub>p-p</sub>
<b>Grid Current</b>	ic/1,2,3,4G		-	8.5	17.0	mA <sub>p-p</sub>
	ic/5,6G		-	11.0	22.0	mA <sub>p-p</sub>
	-		-	-	-	mA <sub>p-p</sub>
	-		-	-	-	mA <sub>p-p</sub>
	-		-	-	-	mA <sub>p-p</sub>
<b>Luminance</b>	L(G)		350 (102)	700 (204)	-	cd/m <sup>2</sup> (fL)
	L(R)		35 (10)	70 (20)		cd/m <sup>2</sup> (fL)
	L(Y)		60 (17)	120 (34)		cd/m <sup>2</sup> (fL)
<b>Luminance Ratio</b>	Lmin/Lmax		50	-	-	%
<b>Grid Cut-off Voltage</b>	Ecco	Ef = 3.5 Vac Eb = 25.0 Vdc	-4.5	-	-	Vdc
<b>Anode Cut-off Voltage</b>	Ebco	Ef = 3.5 Vac ec = 25.0 Vp-p Du = 1/9 tp = 100 uS	-4.5	-	-	Vdc

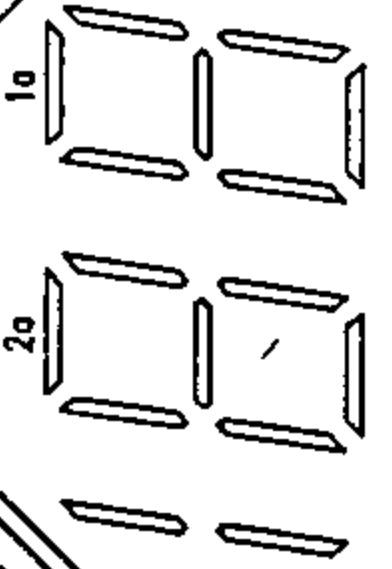
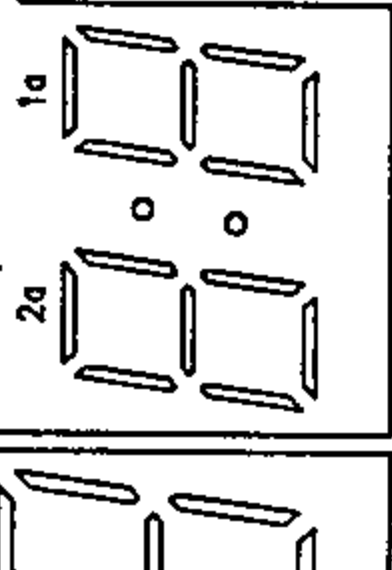
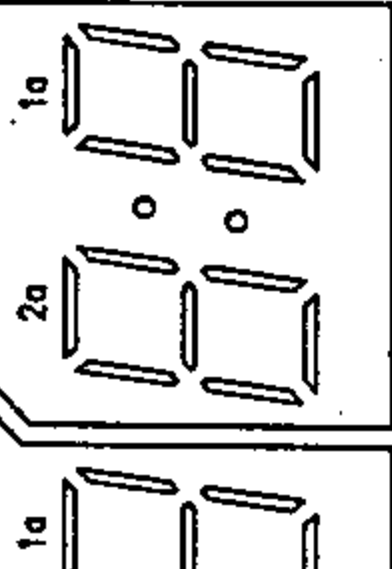

PINOUT CONNECTIONS

Pin No.	1	2	3	4	5	6	7	8	9	10	11	12	13	14	15	16	17	18
Connection	F	F	NP	P1	P2	P3	P4	P5	P6	P7	P8	P9	P10	P11	P12	P13	P14	P15
Pin No.	19	20	21	22	23	24	25	26	27	28	29	30	31	32	33	34	35	
Connection	P16	NC	NC	NC	NC	NC	NC	NC	6G	5G	4G	3G	2G	1G	NP	F	F	

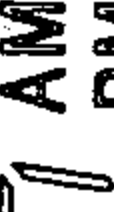
F: Filament G: Grid P: Anode NP: No Pin NC: No Connection

 MP3 PBC CHAPTER SVCD TRACK DVD-A TITLE	CHANNEL 	DIGITAL 	REMAIN 	 ANGLE REPEAT  L/R	PROGRAM RANDOM ALL A - B Su Mo Tu  We Th Fr Sa
--	---	--	--	--	--

6G 5G 4G 3G 2G 1G

CHAPTER, TRACK, TITLE, 5G

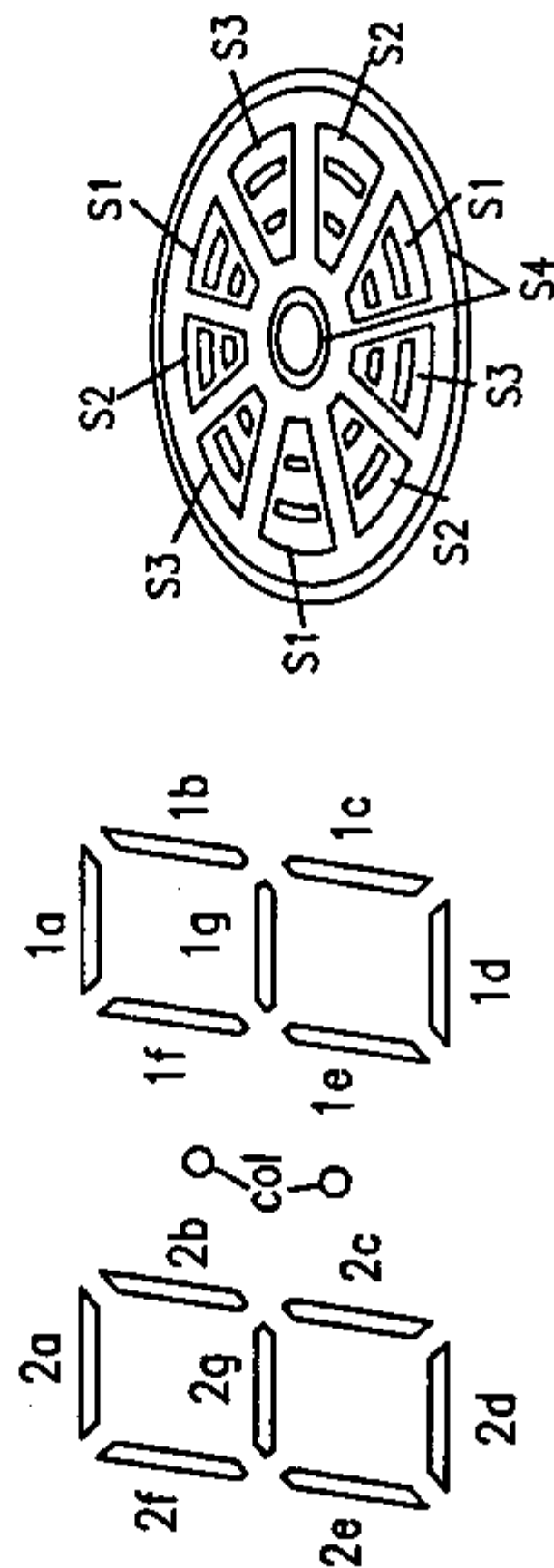

	6G	5G	4G	3G	2G	1G
P1	CHAPTER	CHANNEL	col	col	L	
P2	TRACK	/	<input type="checkbox"/> DIGITAL	REMAIN	/	PROGRAM
P3	<input type="checkbox"/> <b>MS</b>	1a	1a	1a	R	RANDOM
P4	MP3	1b	1b	1b	<input type="radio"/> <b>G</b>	A-
P5	S1	1c	1c	1c	REPEAT	ALL
P6	S3	1d	1d	1d	PM	
P7	S2	1e	1e	1e	AM	Su
P8		1f	1f	1f	<input type="checkbox"/> <b>REC</b>	B
P9	S4	1g	1g	1g	ANGLE	
P10	PBC	2a	2a	2a	d	Mo
P11	CD	2b	2b	2b	b	Tu
P12	DVD	2c	2c	2c	c	Th
P13	TITLE	2d	2d	2d	d	Sa
P14	-A	2e	2e	2e	e	Fr
P15	V	2f	2f	2f	f	<b>P</b>
P16	S	2g	2g	2g	g	Wa