

PRODUCT SPECIFICATION

Part Number
PLC3020-WCNW75-N0x

Details

- Single Color Surface Mount LED
- PLCC-2 3.0 x 2.0 x 0.8mm
- Package: 4,000 piece reels
- Emitting Color: Natural White
- InGaN dice used

Features

- High luminous intensity
- Wide viewing angle 120°
- JEDEC MSL 2a
- Compatible lead-free reflow soldering process
- RoHS Compliant

Mechanical Dimensions

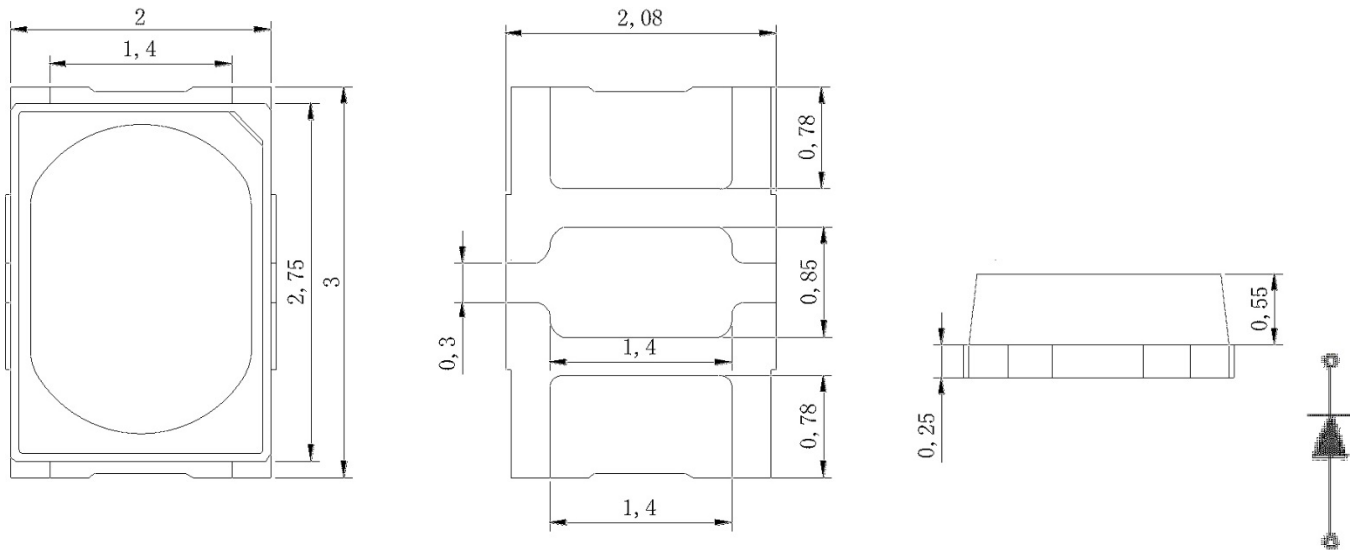

Notes:

1. Specifications subject to change without notice
2. Tolerance of measurement of dimensions: $\pm 0.2\text{mm}$



Device Selection Guide

Model Number	Chip		Encapsulation
	Material	Emitting Color	
PLC3020-WCNW75-N0x	InGaN	Natural White	Silicone Resin

Absolute Maximum Ratings at Ta=25 °C

Parameter	Symbol	Rating	Unit
Power Dissipation	Pd	186	mW
Forward Current	IF	60	mA
Peak Forward Current (1)	IFP	100	mA
Reverse Voltage	VR	5	V
LED Junction Temperature (2)	Tj	110	°C
Operating Temperature	Topr	-40~+85	°C
Storage Temperature	Tstg	-40~+100	°C
Soldering Temperature	Tsol	Reflow Soldering: 260°C for 10 sec Hand Soldering: 350°C for 3 sec	

Notes: 1. Pulse width ≤ 0.1 msec, duty $\leq 1/10$

2. Proper current rating must be observed to maintain junction temperature below the maximum at all the time.

Electrical and Optical Characteristics at Ta=25 °C

Parameter	Symbol	Min.	Typ.	Max.	Unit	Condition
Forward Voltage	VF	--	3.1	--	V	IF=60mA
Luminous Flux	Φ_v	--	19	--	md	
Color Rendering Index	Ra	--	75	--	CRI	
Viewing Angle	2 θ 1/2	--	120	--	deg	
Reverse Current	IR	--	--	10	μ A	VR=5V

Recommended Soldering Pad Pattern

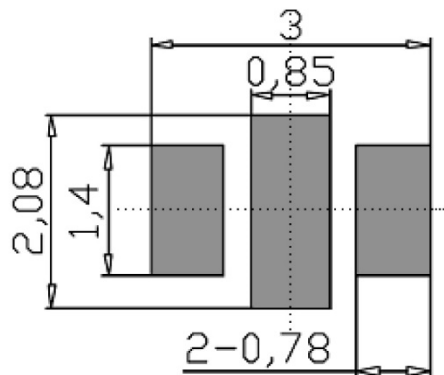

Luminous Intensity Rank Limits (IF = 60mA)

Part Number	Luminous Flux			
	P157	P173	P190	P230
PLC3020-WCNW75-N0x	15.7-17.2	17.3-19.0	19.0-23.0	23.0-25.3

Note: Tolerance of measurement of luminous flux: $\pm 7\%$

Forward Voltage Rank Limits

VF Rank	Min	Max	Unit	Condition
V28	2.8	2.9	V	IF = 60mA
V29	2.9	3.0		
V30	3.0	3.1		
V31	3.1	3.2		
V32	3.2	3.3		
V33	3.3	3.4		

Color Rank Limits (IF = 60mA)

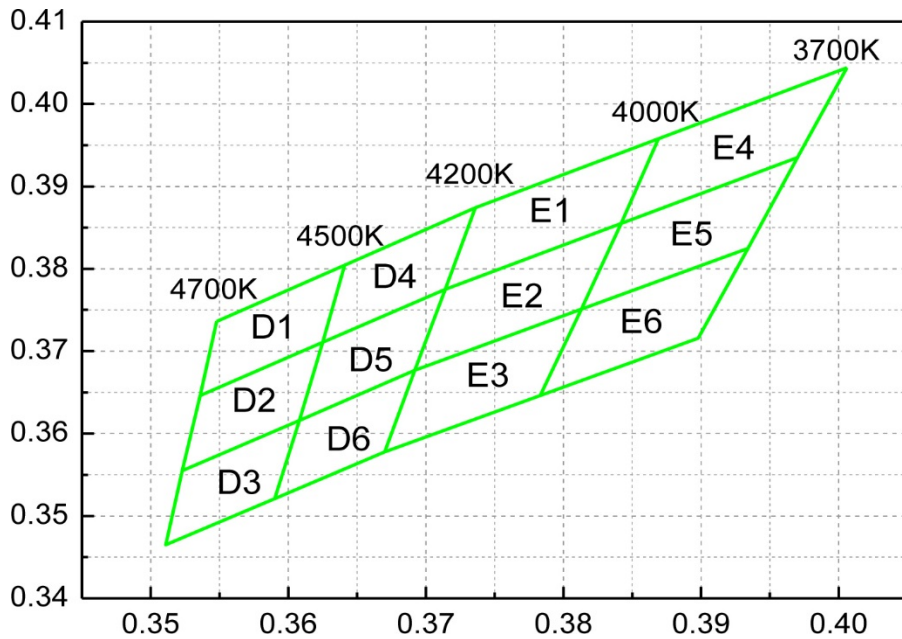

Rank D Color Temperature:4500~4700K					
D1		D2		D3	
CIE X	CIE Y	CIE X	CIE Y	CIE X	CIE Y
0.3548	0.3736	0.3536	0.3646	0.3523	0.3555
0.3536	0.3646	0.3523	0.3555	0.3511	0.3465
0.3625	0.3711	0.3608	0.3616	0.3590	0.3521
0.3641	0.3804	0.3625	0.3711	0.3608	0.3616

Rank D Color Temperature:4200~4500K					
D4		D5		D6	
CIE X	CIE Y	CIE X	CIE Y	CIE X	CIE Y
0.3641	0.3804	0.3625	0.3711	0.3608	0.3616
0.3625	0.3711	0.3608	0.3616	0.359	0.3521
0.3714	0.3775	0.3692	0.3677	0.3670	0.3578
0.3736	0.3874	0.3714	0.3775	0.3692	0.3677

Rank E Color Temperature:4000~4200K					
E1		E2		E3	
CIE X	CIE Y	CIE X	CIE Y	CIE X	CIE Y
0.3736	0.3874	0.3714	0.3775	0.3692	0.3677
0.3714	0.3775	0.3692	0.3677	0.3670	0.3578
0.3842	0.3855	0.3813	0.3751	0.3783	0.3646
0.3869	0.3958	0.3842	0.3855	0.3813	0.3751

Rank E Color Temperature:3700~4000K					
E4		E5		E6	
CIE X	CIE Y	CIE X	CIE Y	CIE X	CIE Y
0.3869	0.3958	0.3842	0.3855	0.3813	0.3751
0.3842	0.3855	0.3813	0.3751	0.3783	0.3646
0.3970	0.3935	0.3934	0.3825	0.3898	0.3716
0.4006	0.4044	0.397	0.3935	0.3934	0.3825

Note: Tolerance of measurement of color coordinates: ± 0.01

Typical Electrical / Optical Characteristic Curves

- $T_a = 25^\circ\text{C}$ Unless Otherwise Noted

Figure1. Forward Current VS. Forward Voltage

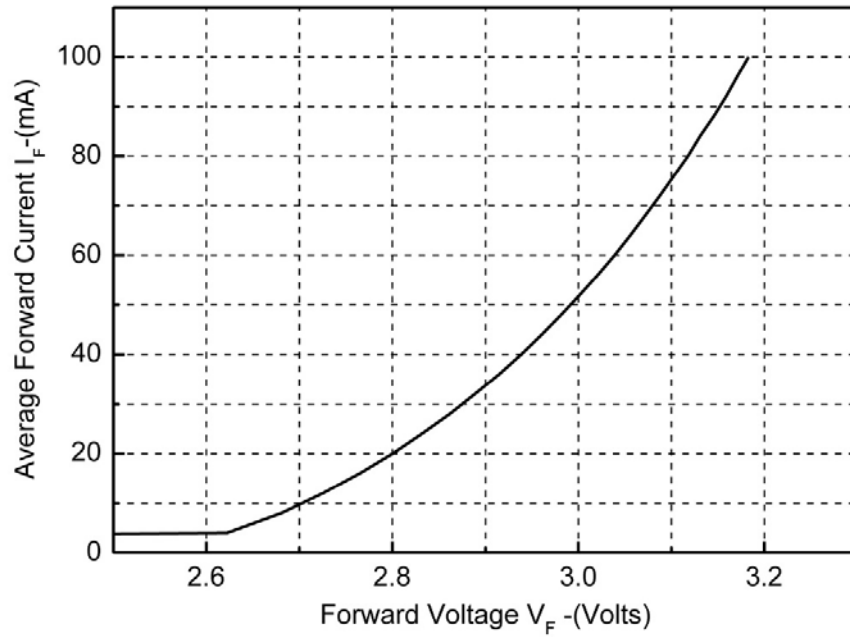

Figure2. Relative Spectral Power Distribution VS. Wavelength

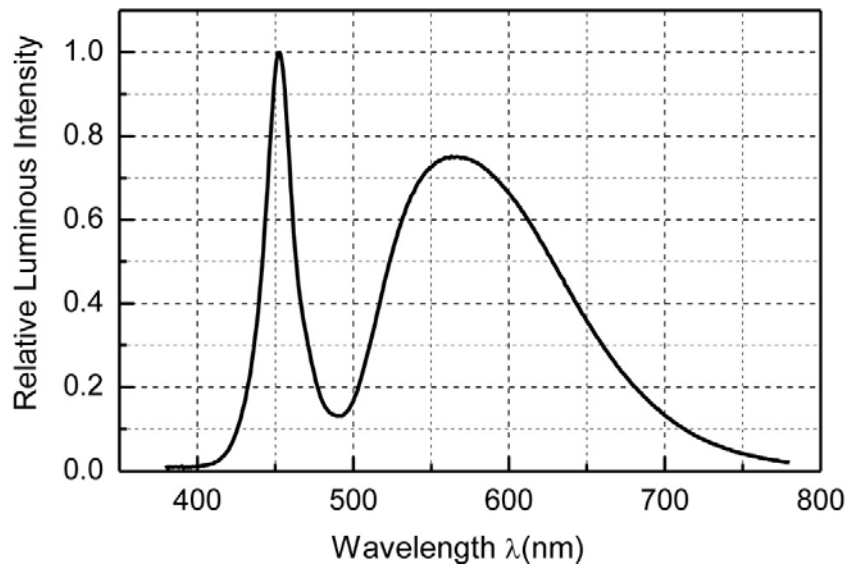
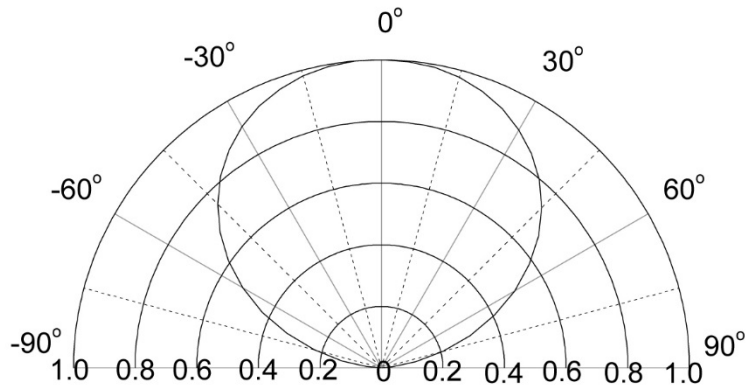
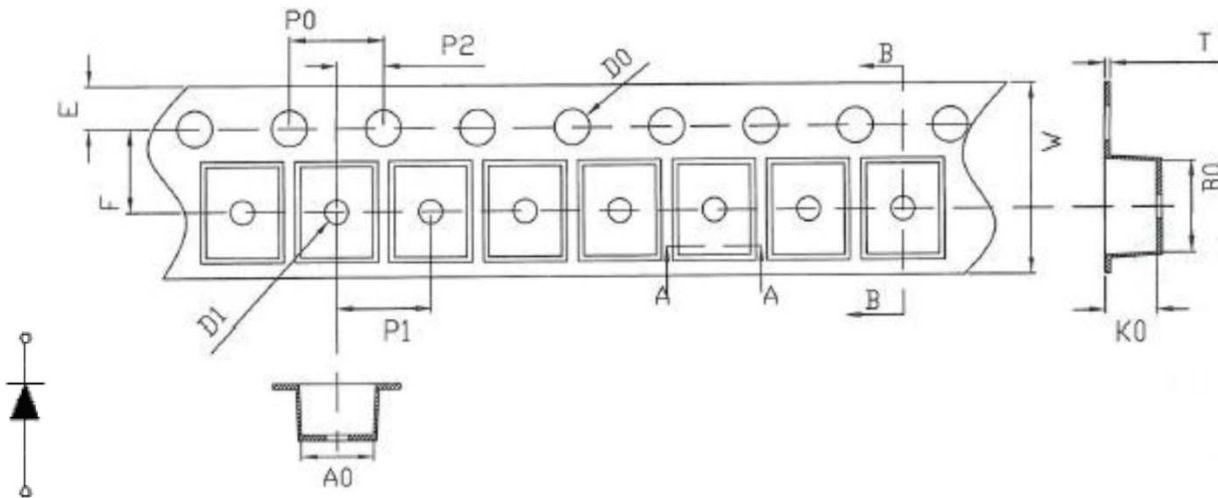

Figure3. Relative Luminosity VS. Radiation Angle



Package – Tape Dimensions



Unit: mm

Symbol	A0	B0	K0	P0	P1	P2	T
Spec	2.20±0.1	3.20±0.1	0.95±0.1	4.00±0.1	4.00±0.1	2.00±0.05	0.25±0.05
Symbol	E	F	D0	D1	W	10P0	
Spec	1.75±0.1	3.50±0.1	1.5+0.1/-0	1.00±0.1/-0	8.00±0.1	40.00±0.2	

Reel Dimensions

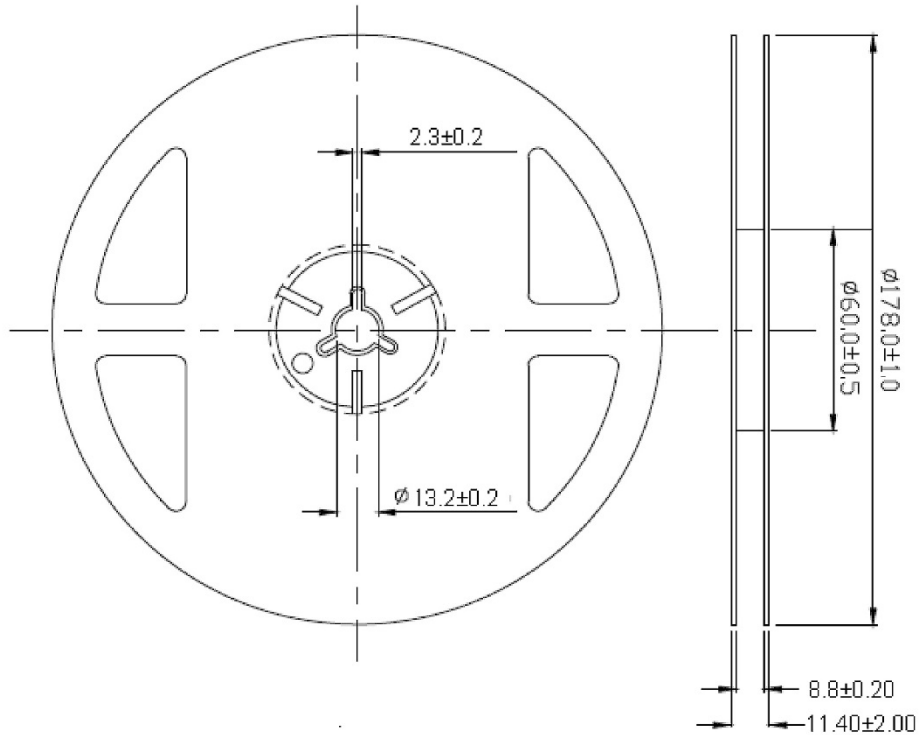

- (1) Quantity: 4,000pcs/Reel
- (2) Tolerance $\pm 0.2\text{mm}$ unless otherwise mentioned

Packaging

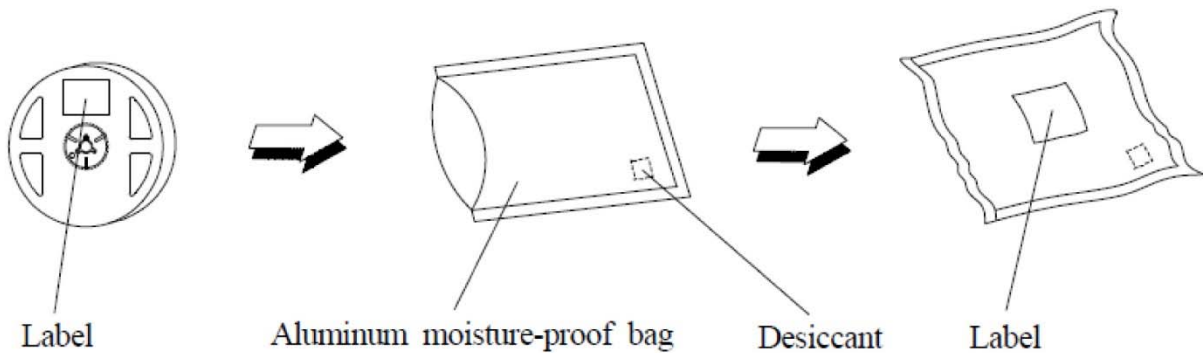

Note: Specifications subject to change without notice

■ **Cautions –**

Users should be cautioned not to stare at the light of this LED product. The bright light can damage the eye

■ **Soldering Characteristics –**

● **Hand Soldering**

Soldering temperature	350°C	One time only
Soldering time	3 sec	

● **Reflow Soldering**

Reflow Soldering		
	Lead Solder	Lead-free Solder
Pre-heat	120~150°C	180~200°C
Pre-heat time	120sec.Max.	120sec.Max.
Peak	240°C Max	260°C Max
Temperature Soldering time Condition	10sec.Max. refer to Temperature-profile A	10sec.Max.refer to Temperature-profile B (N ₂ reflow is recommended)

A: Lead Solder

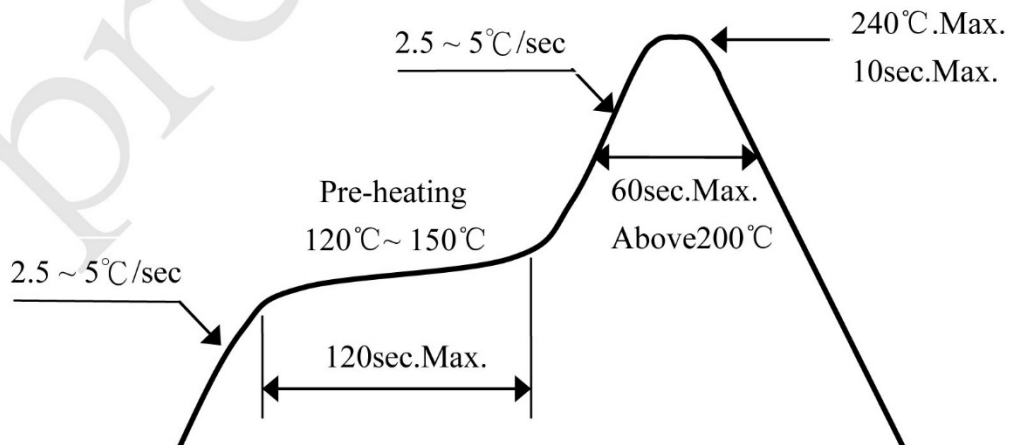

B: Lead-free Solder

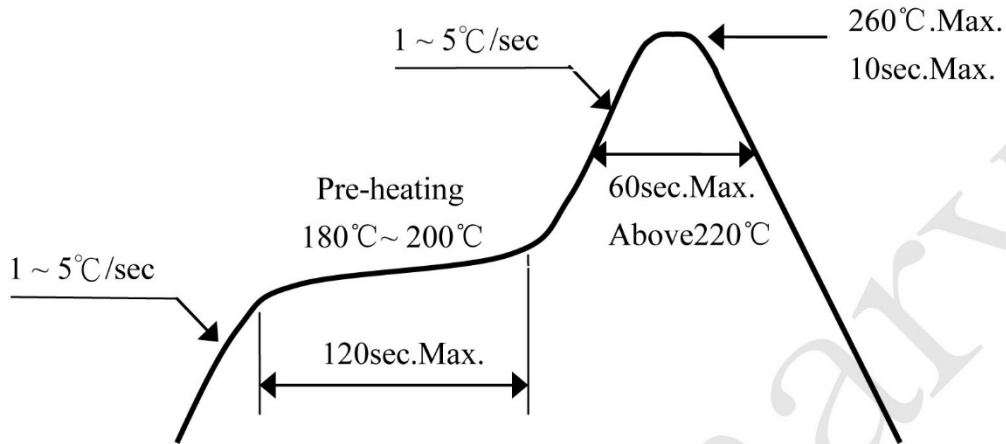

Notes:

- *Although the recommended soldering conditions are specified in above table, reflow or hand soldering at the lowest possible temperature is desired for the LEDs.
- *A rapid-rate process is not recommended for cooling the LEDs down from the peak temperature.
- *All temperatures refer to solder Pad.

■ JEDEC Information –

JEDEC is used to determine what classification level should be used for initial reliability qualification. Once identified, the LEDs can be properly packaged, stored and handled to avoid subsequent thermal and mechanical damage during the assembly solder attachment and/or repair operation. PLCC 3020 series are certified at level 2a.

Characteristics for PLCC 3020 series

Level	Floor Life		Soak Requirements			
			Standard		Accelerated Equivalent	
	Time	Condition	Time(hours)	Condition	Time(hours)	Condition
2a	4 weeks	≤30°C/60%RH	696+5/-0	30°C/60%RH	120+1/-0	60°C/60%RH

Notes: The standard soak time includes a default value of 24 hours for semiconductor manufacturer's exposure time (MET) between bake and bag, and includes maximum time allowed out of the bag at the distributor's facility

■ Reliability-
● Tests and Results

NO.	Test Item	Standard Test Method	Test Conditions	Test Duration	Failure Criteria #	Units Failed/Tested
1	Resistance to Soldering Heat (Reflow Soldering)	JEITA ED-4701 300 301	Tsld=260°C, 10sec,reflows Pretreatment30°C,70%,168hrs		#1	0/20
2	Solderability (Reflow Soldering)	JEITA ED-4701 300 303A	Tsld=245±5°C,5sec. Lead-free Solder(Sn-3.0Ag-0.5Cu)		#3	0/20
3	Thermal Shock		-40°C~110°C 10min dwell, 5min transfer, Pretreatment:30°C,70%,168hrs	100cycles	#1	0/20
4	Temperature Cycle	JEITA ED-4701 100 105	-40°C (30min) ~25°C (5min) ~ 110°C (30min) ~25°C (5min)	100cycles	#1	0/20
5	High Temperature Storage	JEITA ED-4701 200 201	Ta=110°C	1000hrs.	#1	0/20
6	Temperature Humidity Storage	JEITA ED-4701 100 103	Ta=60°C, RH=90%	1000hrs.	#1	0/20
7	Low Temperature Storage	JEITA ED-4701 200 202	Ta=-40°C	1000hrs.	#1	0/20
8	Room Temperature Operating life		Ta=25°C, IF=20mA	1000 hrs.	#2	0/20
9	High Temperature Operating life		Ta=65°C, IF=20mA	1000hrs.	#2	0/20
10	Temperature Humidity Operating life		60°C, RH=90%, IF=20mA	1000hrs.	#2	0/20
11	Low Temperature Operating life		Ta=-40°C, IF=20mA	1000hrs.	#2	0/20

Notes:

Measurements are performed after allowing the LEDs to return to room temperature.

● **Failure Criteria**

Criteria #	Items	Conditions	Failure Criteria
#1	Forward Voltage(VF)	IF=20mA	>U.S.L.X1.1
	Luminous Intensity(IV)	IF=20mA	<L.S.L.X0.7
#2	Forward Voltage(VF)	IF=20mA	>U.S.L.X1.1
	Luminous Intensity(IV)	IF=20mA	<L.S.L.X0.5
#3	Solderability		Less than 95% solder coverage

U.S.L.: Upper Specification limit **L.S.L.:** Lower Specification Limit

■ **Handling of Silicone Resin LEDs-**

● **Handling Indications**

- i. When handling the product, do not touch it directly with bare hands as it may contaminate the surface and affect on optical characteristics. In the worst cases, excessive force to the product might result in catastrophic failure due to package damage and/or wire breakage.



- ii. When handling the product with tweezers, LEDs should only be handled from the side and make sure that excessive force is not applied to the resin portion of the product. Failure to comply can cause the resin portion of the product to be cut, chipped, delaminated and/or deformed, and wire to be broken, and thus resulting in catastrophic failure.



- **Pick and place**

Recommended conditions: Outer nozzle > $\Phi 1.4\text{mm}$

Avoid direct contact to the encapsulant with picking up nozzle. Failure to comply might result in pick and place processes or damage to encapsulant. In the worst cases, catastrophic failure of the LEDs due to wire deformation and/or breakage.

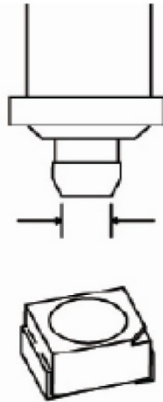

- **Storage –**

- Storage Conditions

A. Before opening the package:

The LEDs should be kept at $\leq 40^{\circ}\text{C}$ and $\leq 90\%\text{RH}$. The LEDs should be used within a year. When storing the LEDs, moisture proof packaging with absorbent material (silica gel) is recommended.

B. After opening the package:

The LEDs should be kept at $\leq 30^{\circ}\text{C}$ and $\leq 60\%\text{RH}$. The LEDs should be soldered within 672 hours (4 weeks) after opening the package. If unused LEDs remain, they should be stored in moisture proof packages, such as sealed containers with packages of moisture absorbent material (silica gel). It is also recommended to return the LEDs to the original moisture proof bag and to reseal the moisture proof bag again.

- If the moisture absorbent material (silica gel) has faded away or the LEDs have exceeded the storage time, baking treatment should be performed using the following conditions.

Baking treatment: more than 24 hours at $60 \pm 5^{\circ}\text{C}$

- This product has silver plated metal parts that are inside and/or outside the package body. The silver plating becomes tarnished when being exposed to an environment

which contains corrosive gases. Any LED with tarnished leads may lead to poor solderability and deterioration of optical characteristics. Please do not expose the LEDs to corrosive atmosphere during storage.

- After assembly and during use, silver plating can be affected by the corrosive gases emitted by components and materials in close proximity of the LEDs within an end product, and the gases entering into the product from the external atmosphere. The above should be taken into consideration when designing.

■ Moisture Proof Package –

- When moisture is absorbed into the SMT package it may vaporize and expand during soldering. There is a possibility that this can cause exfoliation of the contacts and damage to the optical characteristics of the LEDs. For this reason, the moisture proof package is used to keep moisture to a minimum in the package.
- The moisture proof package is made of an aluminum moisture proof bag. A package of a moisture absorbent material (silica gel) is inserted into the aluminum moisture proof bag. The silica gel changes its color from blue to red as it absorbs moisture.
- Please avoid rapid transitions in ambient temperature, especially in high humidity environments where condensation can occur.

■ Recommended circuit –

- In designing a circuit, the current through each LED must not exceed the absolute maximum rating specified for each LED. It is recommended to use Circuit B which regulates the current flowing through each LED. In the meanwhile, when driving LEDs with a constant voltage in Circuit A, the current through the LEDs may vary due to the variation in forward voltage (VF) of the LEDs. In the worst case, some LED may be subjected to stresses in excess of the absolute maximum rating.

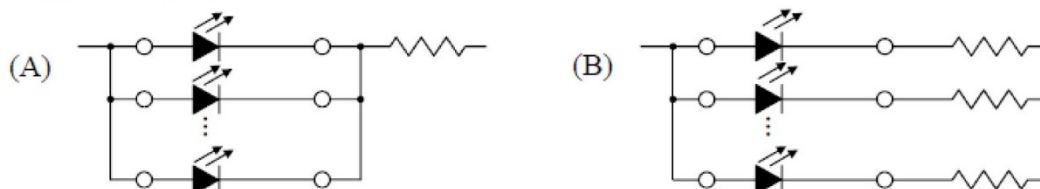

- This product should be operated in forward bias. A driving circuit must be designed so that the product is not subjected to either forward or reverse voltage while it is off.

In particular, if a reverse voltage is continuously applied to the product, such operation can cause migration resulting in LED damage.

■ **Heat Generation –**

- Thermal design of the end product is of paramount importance. Please consider the heat generation of the LED when making the system design. The coefficient of temperature increase per input electric power is affected by the thermal resistance of the circuit board and density of LED placement on the board, as well as other components. It is necessary to avoid intense heat generation and operate within the maximum ratings given in this specification.
- The operating current should be decided after considering the ambient maximum temperature of LEDs.

■ **Static Electricity –**

- Static electricity or surge voltage damages the LEDs. It is recommended that a wrist band or an anti-electrostatic glove be used when handling the LEDs.
- All devices, equipment and machinery must be properly grounded. It is recommended that precautions be taken against surge voltage to the equipment that mounts the LEDs.
- When inspecting the final products in which LEDs were assembled, it is recommended to check whether the assembled LEDs are damaged by static electricity or not. It is easy to find static-damaged LEDs by a light-on test or a VF test at a lower current (below 1mA is recommended).
- Damaged LEDs will show some unusual characteristics such as the leak current remarkably increases, the forward voltage becomes lower, or the LEDs do not light at the low current.

Criteria: (VF > 2.0V at IF=0.5mA)

■ **Cleaning –**

- It is recommended that isopropyl alcohol be used as a solvent for cleaning the LEDs. When using other solvents, it should be confirmed beforehand whether the solvents will dissolve the package and the resin or not. Freon solvents should not be used to clean the LEDs because of worldwide regulations.
- Do not clean the LEDs by the ultrasonic. When it is absolutely necessary, the influence of ultrasonic cleaning on the LEDs depends on factors such as ultrasonic power and the assembled condition. Before cleaning, a pre-test should be done to confirm whether any damage to the LEDs will occur.



PLC3020-WCNW75-N0x Customer Approval Signatures	Approved By	Checked By	Prepared By

Record Of Revisions			
Rev.	Comments	Page	Date
0	Released Spec	--	01/13/14
1	Added new logo	--	03/18/15