

KEMET Part Number: M3253503E1B101JZMB-T&R
(C0603K101J1EML7189)

SMD MIL C0G PRF32535, Ceramic, Military/High Reliability, 100 pF, 5%, 100 V, C0G, SMD, Low ESR, MIL-PRF-32535, N/A, 0603

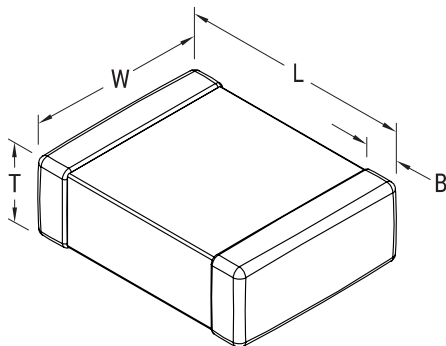

Dimensions

L (Imperial)	0.063 Inches +/-0.006 Inches
L	1.6mm +/-0.15mm
W (Imperial)	0.032 Inches +/-0.006 Inches
W	0.81mm +/-0.15mm
T (Imperial)	0.039 Inches MAX
T	0.99mm MAX
B (Imperial)	0.016 Inches +/-0.008 Inches
B	0.41mm +/-0.2mm

Packaging Specifications

Packaging:	T&R
Packaging Quantity:	4000

General Information

Supplier:	KEMET
Series:	SMD MIL C0G PRF32535
Style:	SMD Chip
Description:	SMD, Low ESR, MIL-PRF-32535
RoHS:	No
Termination:	Solder Plated
Failure Rate:	N/A
Qualifications:	MIL-PRF-32535 M-Level
Chip Size:	0603
Shelf Life:	78 Weeks
MSL:	1

Specifications

Capacitance:	100 pF
Capacitance Tolerance:	5%
Voltage DC:	100 VDC
Dielectric Withstanding Voltage:	250 V
Temperature Range:	-55/+125C
Temperature Coefficient:	C0G
Dissipation Factor:	0.15% 1MHz 25C
Aging Rate:	0% Loss/Decade Hour
Insulation Resistance:	100 GOhms