150 mA 24 V Input High Voltage Regulator

NO.EA-270-150702

OUTLINE

The R1155x is a CMOS-based 24 V input voltage regulator featuring 150 mA output that provides high output voltage accuracy and low supply current. Internally, the R1155x consists of a voltage reference unit, an error amplifier, and a resistor net for setting output voltage. As protection circuits, the R1155x contains a current limit circuit, a fold-back protection circuit, a thermal shutdown circuit and a reverse current protection circuit.

The R1155x is available in the fixed output voltage type (R1155xxxxB), and the adjustable output voltage type (R1155x001C). The output voltage accuracy for the fixed output voltage type is as high as $\pm 2.0\%$.

The R1155x is offered in a 5-pin SOT-89-5 package and a 5-pin SOT-23-5 package.

FEATURES

- Supply Current Typ. 7.5 μA ($V_{\text{IN}} = 6.0 \text{ V}$ or 3.0 V)
- Standby Current Typ. 0.1 μA
- Output Current Min. 150 mA ($V_{\text{IN}} = 6.0 \text{ V}$ or 3.0 V)
- Output Voltage Accuracy $\pm 2.0\%$
- Package SOT-23-5, SOT-89-5
- Input Voltage Range Max. 24.0 V
- Output Voltage Range Fixed Output Voltage Type: 2.5 V to 12.0 V
Adjustable Output Voltage Type: 2.5 V, 2.5 V to 23.0 V
using external resistor
- Fold-back Protection Circuit Typ. 30 mA
- Thermal Shutdown Circuit
- Reverse Current Protection Circuit
- Ceramic Capacitor Capable $C_{\text{OUT}} = 4.7 \mu\text{F}$ or more

APPLICATIONS

- Power source for home appliances (refrigerators, rice cookers, electric water warmers, etc.)
- Power source for in-car audio systems, in-car navigation systems, ETC systems, and reset circuits
- Power source for laptop personal computers, digital TVs, cordless phones, and private LAN systems for home, and reset circuits
- Power source for copiers, printers, facsimiles, scanners, and reset circuits

R1155x

NO.EA-270-150702

SELECTION GUIDE

The output voltage, the output voltage type, and the package type for the ICs are user-selectable options.

Selection Guide

Product Name	Package	Quantity per Reel	Pb Free	Halogen Free
R1155Nxxx*-TR-FE	SOT-23-5	3,000 pcs	Yes	Yes
R1155Hxxx*-T1-FE	SOT-89-5	1,000 pcs	Yes	Yes

xxx: Designation of the output voltage (V_{SET})

For Fixed Output Voltage Type: 2.5 V (025) to 12 V (120) in 0.1 V steps

For Adjustable Output Voltage Type: 2.5 V (001) only

*: Designation of the output voltage type

(B) Fixed Output Voltage Type

(C) Adjustable Output Voltage Type

BLOCK DIAGRAMS

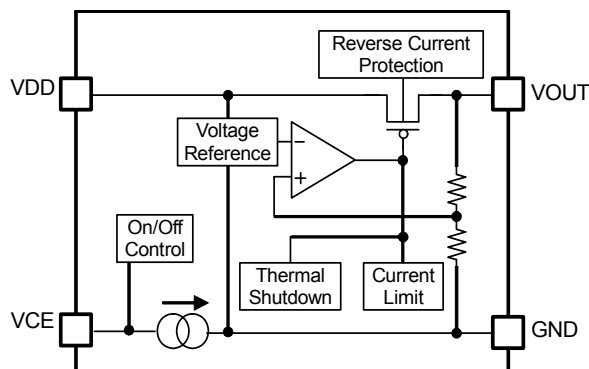

R1155xxxxB Block Diagram
(Fixed Output Voltage Type)

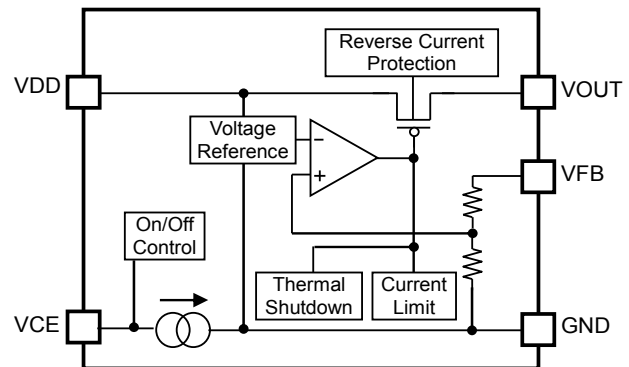

R1155x001C Block Diagram
(Adjustable Output Voltage Type)

PIN DESCRIPTION

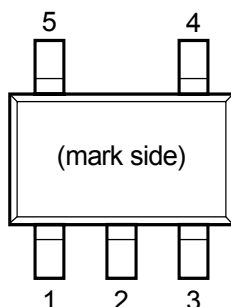

SOT-23-5 Pin Configuration

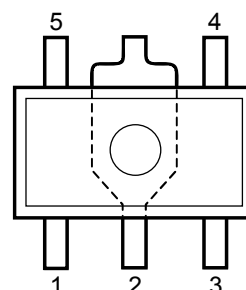

SOT-89-5 Pin Configuration

SOT-23-5 Pin Description

Pin No	Symbol	Description	
1	VOUT	VR Output Pin	
2	GND	Ground Pin	
3	VDD	Input Pin	
4	TP ¹	R1155NxxxB	Test Pin
	VFB ²	R1155N001C ³	VR Adjustment Pin
5	CE	Chip Enable Pin, Active-high	

SOT-89-5 Pin Description

Pin No	Symbol	Description	
1	VOUT	VR Output Pin	
2	GND	Ground Pin	
3	CE	Chip Enable Pin, Active-high	
4	TP ¹	R1155HxxxB	Test Pin
	VFB ²	R1155H001C ³	VR Adjustment Pin
5	VDD	Input Pin	

¹ The TP pin must be connected to GND.

² A 24 MΩ or less voltage setting resistor must be connected to the VFB pin.

³ As for the adjustable output voltage type (R1155N001C), please refer to *ADJUSTABLE OUTPUT VOLTAGE TYPE SETTING*.

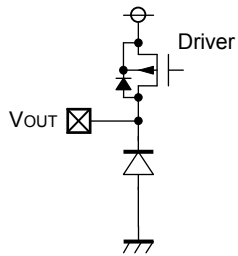
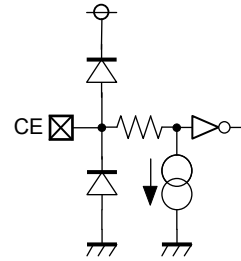
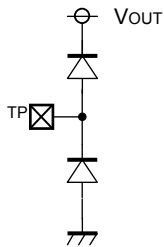
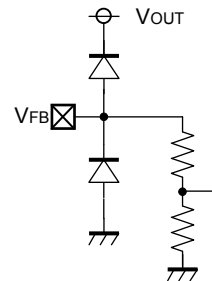
PIN EQUIVALENT CIRCUIT DIAGRAMS**VOUT Pin Equivalent Circuit Diagram****VFB Pin Equivalent Circuit Diagram****TP Pin Equivalent Circuit Diagram
(R1155xxxxB)****VFB Pin Equivalent Circuit Diagram
(R1155x001C)**

ABSOLUTE MAXIMUM RATINGS

Absolute Maximum Ratings

Symbol	Item	Rating	Unit	
V_{IN}	Input Voltage	-0.3 to 26	V	
V_{CE}	Input Voltage (CE Pin)	-0.3 to $V_{IN} + 0.3$	V	
V_{OUT}	Output Voltage	-0.3 to 26	V	
V_{VFB}	Output Voltage (VFB Pin)	-0.3 to 26	V	
I_{OUT}	Output Current	350	mA	
P_D	Power Dissipation (Standard Land Pattern) ¹	SOT-23-5	420	mW
		SOT-89-5	900	
T_j	Junction Temperature	-40 to 125	°C	
T_{stg}	Storage Temperature Range	-55 to 125	°C	

ABSOLUTE MAXIMUM RATINGS

Electronic and mechanical stress momentarily exceeded absolute maximum ratings may cause the permanent damages and may degrade the life time and safety for both device and system using the device in the field. The functional operation at or over these absolute maximum ratings is not assured.

RECOMMENDED OPERATING CONDITIONS

Recommended Operating Ratings

Symbol	Item	Ratings	Unit
T_a	Operating Temperature Range	-40 to 105	°C
V_{IN}	Input Voltage	3.5 to 24	V

RECOMMENDED OPERATING RATINGS

All of electronic equipment should be designed that the mounted semiconductor devices operate within the recommended operating ratings. The semiconductor devices cannot operate normally over the recommended operating ratings, even if when they are used over such ratings by momentary electronic noise or surge. And the semiconductor devices may receive serious damage when they continue to operate over the recommended operating ratings.

¹ Refer to *POWER DISSIPATION* in *SUPPLEMENTARY ITEMS* for detail information.

R1155x

NO.EA-270-150702

ELECTRICAL CHARACTERISTICS

$V_{IN} = V_{CE} = V_{SET} + 3.0 \text{ V}$, $C_{OUT} = 4.7 \text{ }\mu\text{F}$, $I_{OUT} = 1 \text{ mA}$, unless otherwise noted.

The specifications surrounded by are guaranteed by Design Engineering at $-40^\circ\text{C} \leq T_a \leq 105^\circ\text{C}$.

R1155xxxxB, R1155x001C Electrical Characteristics

($T_a = 25^\circ\text{C}$)

Symbol	Item	Conditions		Min.	Typ.	Max.	Unit
I_{LIM}	Output Current	$V_{IN} = V_{SET} + 4 \text{ V}$		150			mA
V_{OUT}	Output Voltage (Low Power Mode)	$I_{OUT} = 1 \text{ mA}$	$T_a = 25^\circ\text{C}$	x0.98		x1.02	V
			$-40^\circ\text{C} \leq T_a \leq 105^\circ\text{C}$	x0.955		x1.03	V
I_{SS1}	Supply Current (Low Power Mode)	$I_{OUT} = 0 \text{ mA}$	$2.5 \leq V_{SET} \leq 4.2 \text{ V}$		7.5	22	μA
			$4.2 < V_{SET} \leq 8.4 \text{ V}$		8.6	22	μA
			$8.4 < V_{SET} \leq 12 \text{ V}$		9.5	22	μA
I_{SS2}	Supply Current (Fast Mode)	$I_{OUT} = 10 \text{ mA}$			65	125	μA
$I_{standby}$	Standby Current	$V_{IN} = 24 \text{ V}$, $V_{CE} = 0 \text{ V}$			0.1	1.0	μA
ΔV_{OUT}	Output Voltage Deviation When Switching Mode	$1 \text{ mA} \leq I_{OUT} \leq 6 \text{ mA}$		-1.5	0	1.5	%
$\Delta V_{OUT} / \Delta I_{OUT}$	Load Regulation (Fast Mode)	$6 \text{ mA} \leq I_{OUT} \leq 150 \text{ mA}$	$2.5 \leq V_{SET} \leq 5 \text{ V}$		30	90	mV
			$5 < V_{SET} \leq 12 \text{ V}$		30	100	mV
$\Delta V_{OUT} / \Delta V_{IN}$	Line Regulation (Low Power Mode)	$V_{SET} + 0.2 \text{ V} \leq V_{IN} \leq 24 \text{ V}$	$I_{OUT} = 1 \text{ mA}$		0.3	1.3	%
	Line Regulation (Fast Mode)	$V_{SET} + 0.2 \text{ V} \leq V_{IN} \leq 24 \text{ V}$	$I_{OUT} = 10 \text{ mA}$		1.2	2.4	%
V_{DIF}	Dropout Voltage	$I_{OUT} = 150 \text{ mA}$	$2.5 \text{ V} \leq V_{SET} < 3.3 \text{ V}$		1.6	2.6	V
			$3.3 \text{ V} \leq V_{SET} < 5 \text{ V}$		0.96	2.1	V
			$5 \leq V_{SET} \leq 12 \text{ V}$		0.55	1.7	V
RR	Ripple Rejection (Fast Mode)	$f = 1 \text{ kHz}$, 0.5 V_{p-p} , $I_{OUT} = 10 \text{ mA}$	$2.5 \leq V_{SET} < 5 \text{ V}$		60		dB
			$5 \leq V_{SET} \leq 12 \text{ V}$		50		dB
$\Delta V_{OUT} / \Delta T_a$	Output Voltage Temperature Coefficient	$I_{OUT} = 1 \text{ mA}$, $-40^\circ\text{C} \leq T_a \leq 105^\circ\text{C}$			± 100		ppm/ $^\circ\text{C}$
I_{OUTH}	Fast Mode Switching Current	$I_{OUT} = \text{Light Load} \rightarrow \text{Heavy Load}$		2.4	4.5	6.5	mA
I_{OUTL}	Low Power Mode Switching Current	$I_{OUT} = \text{Heavy Load} \rightarrow \text{Light Load}$		0.6	1.5	2.4	mA
I_{SC}	Short Current Limit	$V_{OUT} = 0 \text{ V}$			30		mA
V_{CEH}	CE Input Voltage "H"			1.35		V_{IN}	V
V_{CEL}	CE Input Voltage "L"			0		0.5	V
T_{TSD}	Thermal Shutdown Temperature	Junction Temperature			145		$^\circ\text{C}$
T_{TSR}	Thermal Shutdown Released Temperature	Junction Temperature			120		$^\circ\text{C}$

All test items listed under *ELECTRICAL CHARACTERISTICS* are done under the pulse load condition ($T_j \approx T_a = 25^\circ\text{C}$) except for Ripple Rejection and Output Voltage Temperature Coefficient.

ELECTRICAL CHARACTERISTICS (continued)

$V_{IN} = V_{CE} = V_{SET} + 3.0 \text{ V}$, $C_{OUT} = 4.7 \text{ }\mu\text{F}$, $I_{OUT} = 1 \text{ mA}$, unless otherwise noted.

The specifications surrounded by are guaranteed by Design Engineering at $-40^\circ\text{C} \leq T_a \leq 105^\circ\text{C}$.

R1155xxxxB, R1155x001C Electrical Characteristics

(Ta = 25°C)

Symbol	Item	Conditions	Min.	Typ.	Max.	Unit
I _{REV}	Reverse Current Limit	CE = GND, V _{IN} = V _{SET} + 0.02 V	2.5 ≤ V _{SET} < 5 V	1.0	3.5	μA
			5 ≤ V _{SET} ≤ 12 V	2.0	6.0	μA
V _{REV_DET}	Reverse Current Protection Mode Detection Offset ¹ V _{REV} = V _{DD} - V _{OUT}	0 ≤ V _{IN} ≤ 24.0 V, V _{OUT} ≥ 2.0 V	20			mV
V _{REV_REL}	Reverse Current Protection Mode Release Offset ¹	0 ≤ V _{IN} ≤ 24.0 V, V _{OUT} ≥ 2.0 V			220	mV

All test items listed under *ELECTRICAL CHARACTERISTICS* are done under the pulse load condition (T_j ≈ T_a = 25°C) except for Ripple Rejection and Output Voltage Temperature Coefficient.

¹ The operation of reverse current protection circuit is guaranteed when V_{OUT} ≥ 2.0 V. The reverse current protection mode is always turned on when V_{IN} = 0 V.

THEORY OF OPERATION

Power Activation

When starting up the IC using the input voltages of the VDD and CE pins simultaneously with no load, the both pin voltages have to be 0.06 V/ ms or faster. When starting up the IC using the both pin voltages at 0.06 V/ ms or slower with no load, the VDD pin has to be started up before the CE pin.

Thermal Shutdown Circuit

The R1155x contains a thermal shutdown circuit, which stops regulator operation if the junction temperature of the R1155x becomes higher than 145°C (Typ.). Additionally, if the junction temperature after the regulator being stopped decreases to a level below 120°C (Typ.), it restarts regulator operation. As a result the operation of the thermal shutdown circuit causes the regulator repeatedly to turn off and on until the causes of overheating are removed. As a consequence a pulse shaped output voltage occurs.

Reverse Current Protection Circuit

The R1155x includes a reverse current protection circuit, which stops the reverse current flowing from the VOUT to VDD pins or to GND pin when VOUT becomes more than VIN.

Usually, the LDO using Pch output transistor contains a parasitic diode between VDD pin and VOUT pin. Therefore, if VOUT is more than VIN, the parasitic diode becomes forward direction. As a result, the current flows from VOUT pin to VDD pin.

The R1155x switches the mode to the reverse current protection mode before VIN becomes smaller than VOUT by connecting the parasitic diode of Pch output transistor to the backward direction, and connecting the gate to VOUT pin. As a result, the Pch output transistor is turned off and the all the current pathways from VOUT pin to GND pin are shut down to maintain the reverse current lower than [IREV] of the Electrical Characteristics. Switching to either the normal mode or to the reverse current protection mode is determined by the magnitude of VIN voltage and VOUT voltage. For the stable operation, offset and hysteresis are set as the threshold. The detection/ release thresholds of both normal and reverse current protection modes are specified by [VREV_DET] and [VREV_REL] of the Electrical Characteristics. Therefore, the minimum dropout voltage under the small load current condition is restricted by the value of [VREV_REL].

Figure 7 and Figure 8 show the normal operation mode and reverse current protection mode, respectively. Figure 9 shows the detection/ release timing of reverse current protection function. When giving the VOUT pin a constant-voltage and decreasing the VIN voltage, the dropout voltage will become lower than the [VREV_DET]. As a result, the reverse current protection starts to function to stop the load current. By increasing the dropout voltage more than the [VREV_REL], the protection mode will be released to let the load current to flow. If the dropout voltage to be used is smaller than [VREV_REL], the detection and the release may be repeated.

The operation coverage of the reverse current protection circuit is $V_{OUT} \geq 1.5 \text{ V}$. However, under the condition of $V_{IN} = 0 \text{ V}$, always the reverse current protection mode is operating.

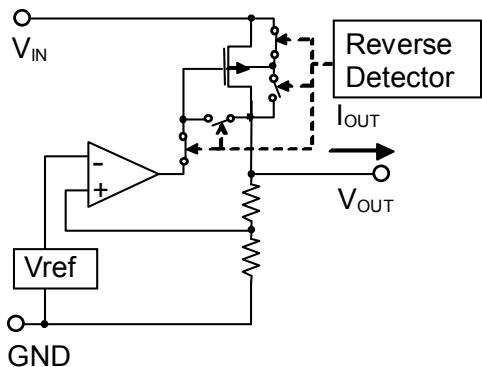

Normal Operation Mode

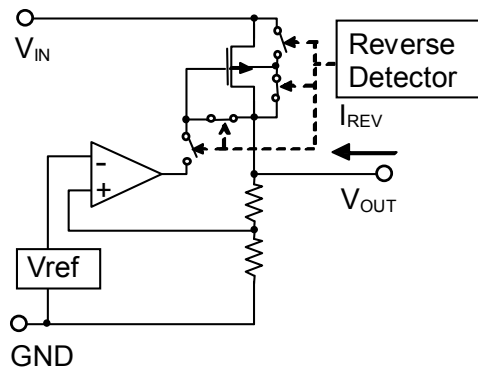

Reverse Current Protection Mode

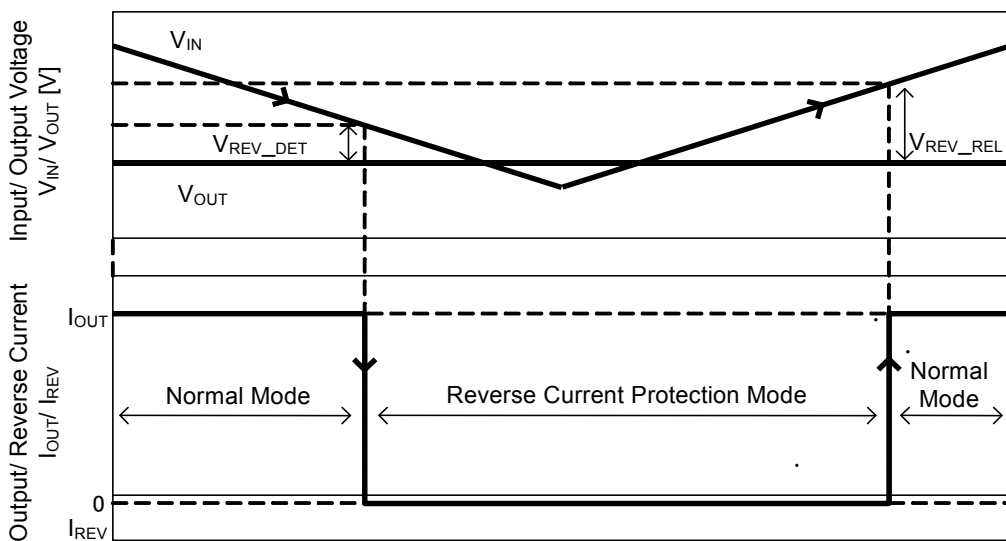

Detection/ Release Timing of Reverse Current Protection Function

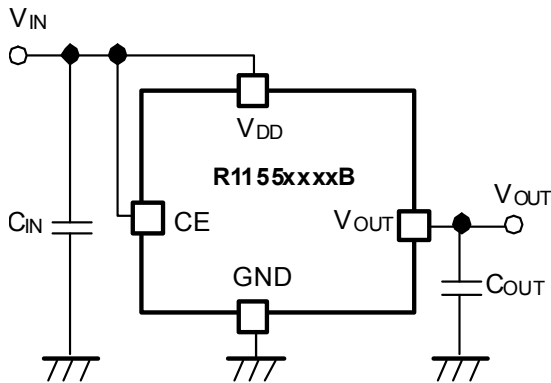
APPLICATION INFORMATION

R1155xxxxB Typical Application
(Fixed Output Voltage Type)

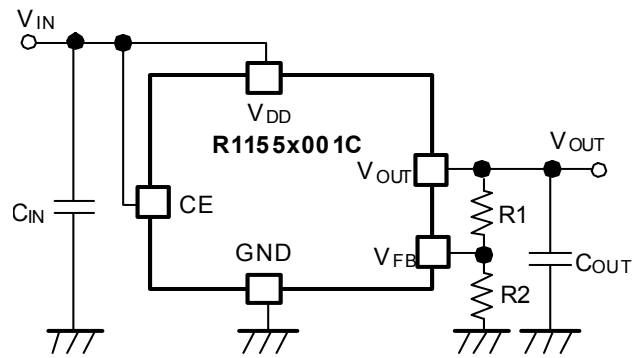

R1155x001C Typical Application
(Adjustable Output Voltage Type)

Technical Notes on the Components Selection

- In the R1155x, phase compensation is provided to secure stable operation even when the load current is varied. For this purpose, use a 4.7 μF or more output capacitor (C_{OUT}) with good frequency characteristics and proper ESR (Equivalent Series Resistance). In case of using a tantalum type capacitor and the ESR value of the capacitor is large, the output might be unstable. Evaluate the circuit including consideration of frequency characteristics.
- Ensure the VDD and GND lines are sufficiently robust. If their impedance is too high, noise pickup or unstable operation may result. Connect C_{OUT} with suitable values between the VOUT and GND pins, and as close as possible to the pins. Please refer to Figure 5 and Figure 6 below.

Adjustable Output Voltage Type Setting (R1155x001C)

The output voltage of the R1155x001C can be adjusted up to 23 V by using the external divider resistors (R1, R2). The resistance value for R2 should be set to 24 MΩ or less. By using the following equations, the output voltage can be determined. V_{FB} voltage which is fixed inside the IC is described as $setV_{FB}$. $setV_{FB}$ is 2.5 V. When using the R1155x001C with 2.5 V, please connect the VOUT pin to the VFB pin.

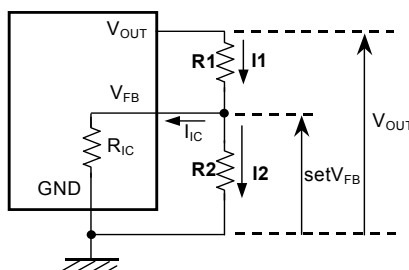

Output Voltage Adjustment Using External Divider Resistors

$$I1 = I_{IC} + I2 \dots\dots\dots (1)$$

$$I2 = setV_{FB} / R2 \dots\dots\dots (2)$$

Thus,

$$I1 = I_{IC} + setV_{FB} / R2 \dots\dots\dots (3)$$

Therefore,

$$V_{OUT} = setV_{FB} + R1 \times I1 \dots\dots\dots (4)$$

Insert Equation (3) into Equation (4), so

$$\begin{aligned} V_{OUT} &= setV_{FB} + R1 \times (I_{IC} + setV_{FB} / R2) \\ &= setV_{FB} \times (1 + R1 / R2) + R1 \times I_{IC} \dots\dots\dots (5) \end{aligned}$$

In Equation (5), $R1 \times I_{IC}$ is the error-causing factor in V_{OUT} .

As for I_{IC} ,

$$I_{IC} = setV_{FB} / R_{IC} \dots\dots\dots (6)$$

Therefore, the error-causing factor $R1 \times I_{IC}$ can be described as follows.

$$\begin{aligned} R1 \times I_{IC} &= R1 \times setV_{FB} / R_{IC} \\ &= setV_{FB} \times R1 / R_{IC} \dots\dots\dots (7) \end{aligned}$$

For better accuracy, choosing $R1 \ll R_{IC}$ reduces this error.

Without the error-causing factor $R1 \times I_{IC}$, the output voltage can be calculated by the following equation.

$$V_{OUT} = setV_{FB} \times ((R1 + R2) / R2) \dots\dots\dots (8)$$

R_{IC} of the R1155x001C is approximately Typ.8.4 MΩ ($T_a = 25^\circ\text{C}$, guaranteed by Design Engineering).

R_{IC} could be affected by the temperature, therefore evaluate the circuit taking the actual conditions of use into account when deciding the resistance values for R1 and R2.

R1155x

NO.EA-270-150702

Equivalent Series Resistance (ESR) vs. Output Current (I_{OUT})

It is recommended that a ceramic type capacitor be used for the R1155x. However, other types of capacitors having lower ESR can also be used. The relation between the output current (I_{OUT}) and the ESR of output capacitor is shown below.

Measurement Conditions:

- Noise Frequency Band: 10 Hz to 2 MHz
- Measurement Temperature: -40°C to $+105^{\circ}\text{C}$
- Hatched Area: Noise level is 40 μV (avg.) or below.
- C_{IN} : 0.1 μF
- C_{OUT} : 4.7 μF

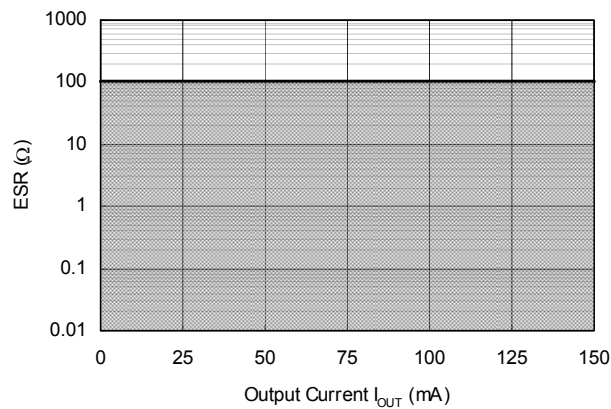

ESR vs. Output Current

TYPICAL CHARACTERISTICS

Note: Typical Characteristics are intended to be used as reference data; they are not guaranteed.

1) Output Voltage vs. Output Current ($C_{IN} = 0.1 \mu F$, $C_{OUT} = 4.7 \mu F$, $T_a = 25^\circ C$)

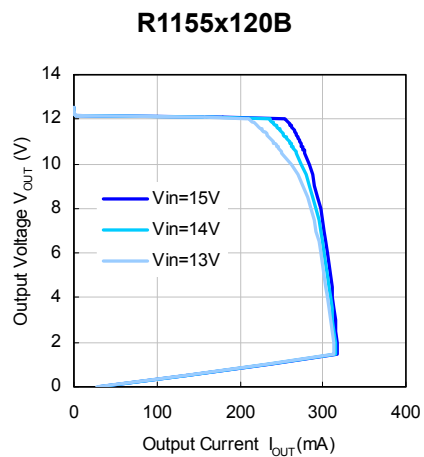
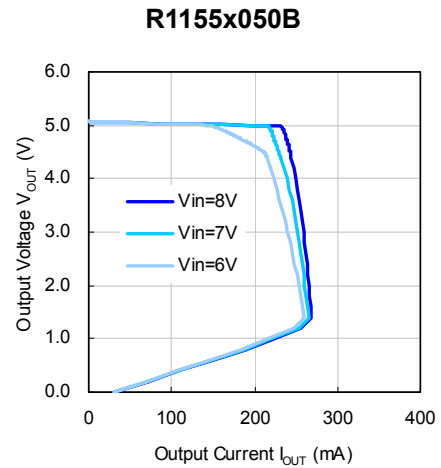
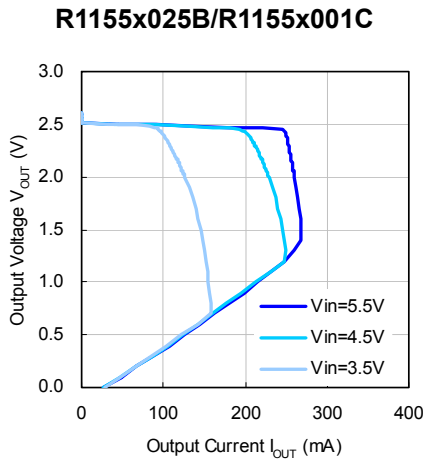

2) Output Voltage vs. Input Voltage ($C_{IN} = 0.1 \mu F$, $C_{OUT} = 4.7 \mu F$, $T_a = 25^\circ C$)

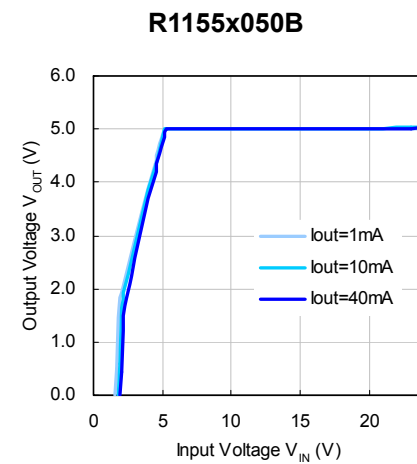
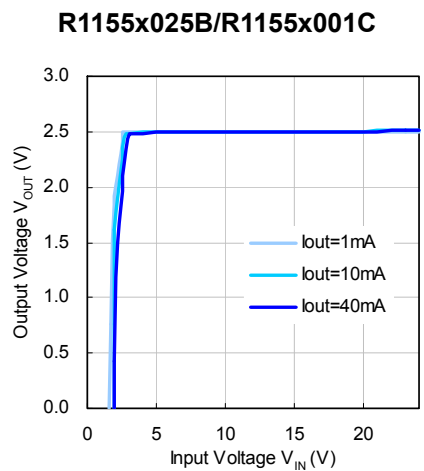

R1155x

NO.EA-270-150702

R1155x120B

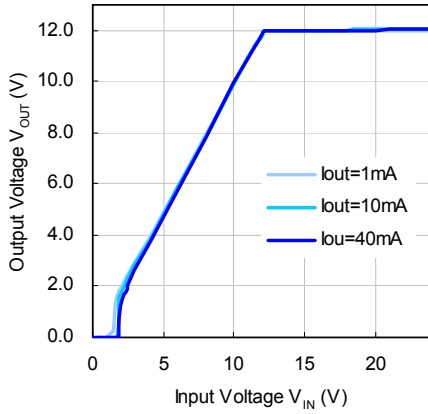

3) Dropout Voltage vs. Output Current ($C_{IN} = 0.1 \mu F$, $C_{OUT} = 4.7 \mu F$)

R1155x025B/R1155x001C

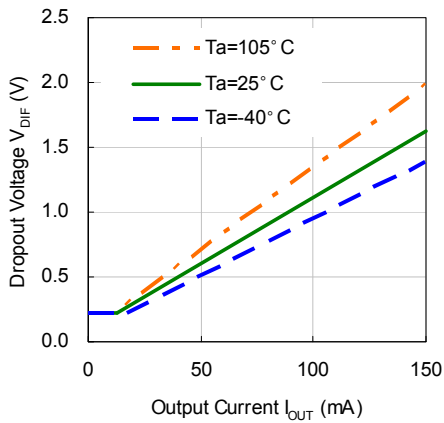

R1155x050B

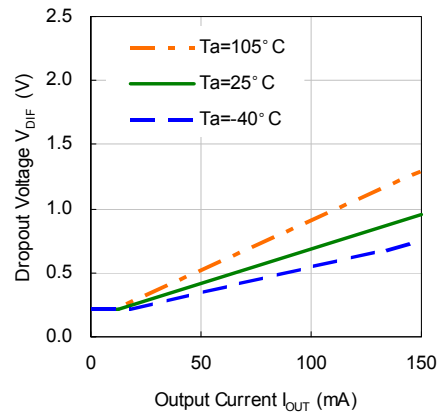

R1155x120B

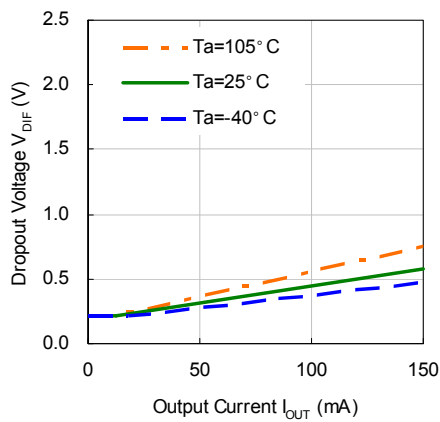

4) Dropout Voltage vs. Set Output Voltage

($C_{IN} = 0.1 \mu F$, $C_{OUT} = 4.7 \mu F$, $T_a = 25^\circ C$)

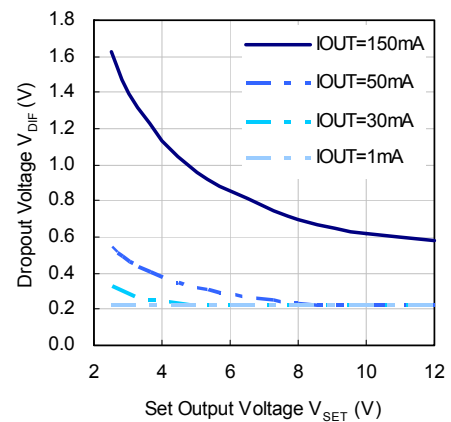

5) Ripple Rejection vs. Frequency ($C_{IN} = \text{none}$, $C_{OUT} = 4.7 \mu\text{F}$, Ripple = 0.2 V_{P-P} , $T_a = 25^\circ\text{C}$)

R1155x025B

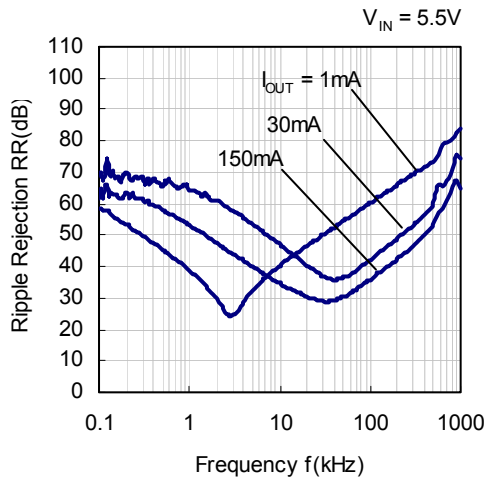

R1155x050B

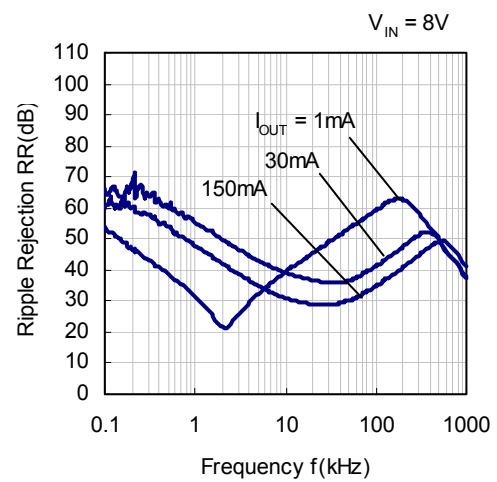

R1155x120B

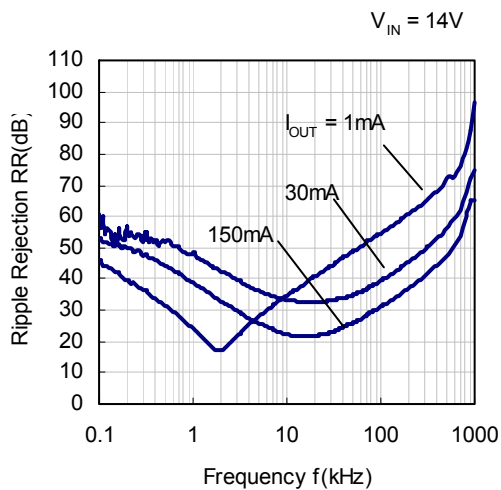

R1155x

NO.EA-270-150702

6) Output Voltage vs. Operating Temperature ($C_{IN} = 0.1 \mu\text{F}$, $C_{OUT} = 4.7 \mu\text{F}$, $T_a = 25^\circ\text{C}$, $I_{OUT} = 1 \text{ mA}$)

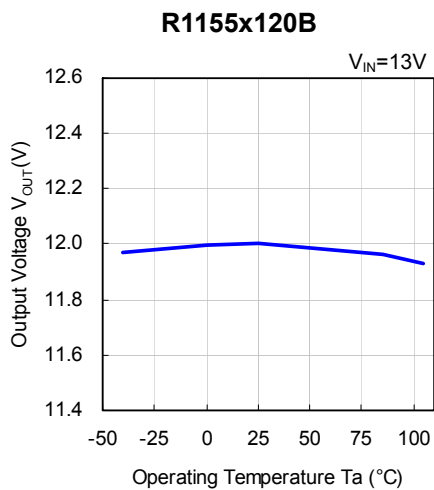
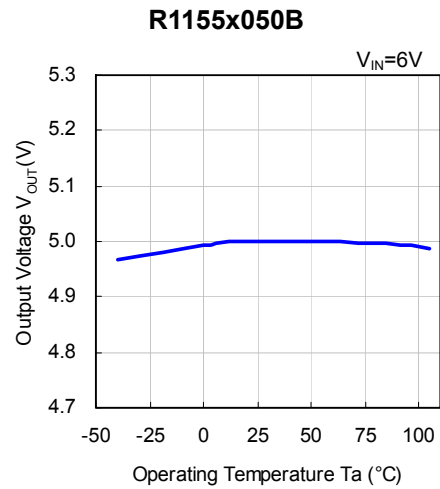
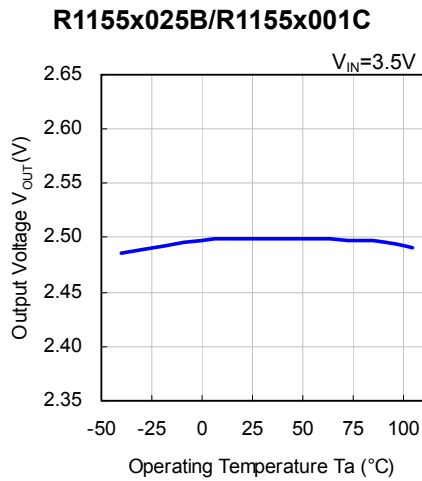

7) Supply Current vs. Input Voltage ($C_{IN} = 0.1 \mu\text{F}$, $C_{OUT} = 4.7 \mu\text{F}$, $T_a = 25^\circ\text{C}$)

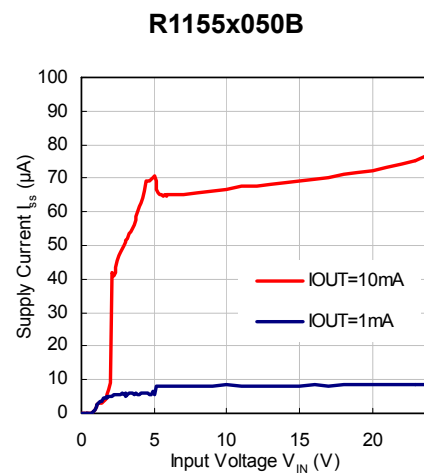
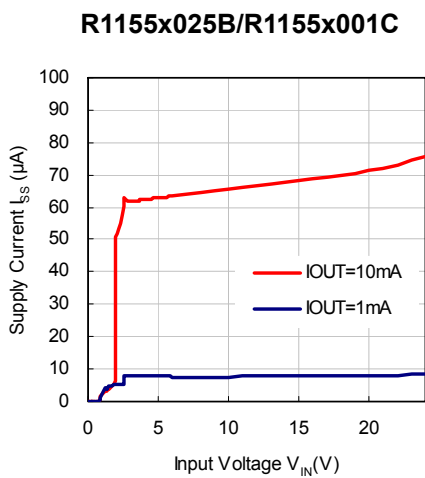

R1155x120B

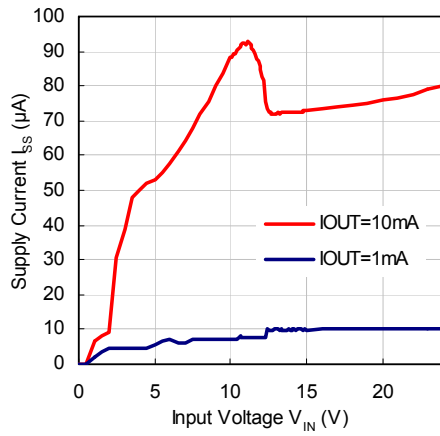

8) Supply Current vs. Operating Temperature ($C_{IN} = 0.1 \mu F$, $C_{OUT} = 4.7 \mu F$)

R1155x025B/R1155x001C

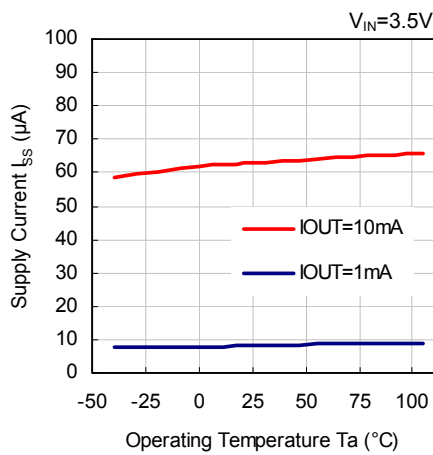

R1155x050B

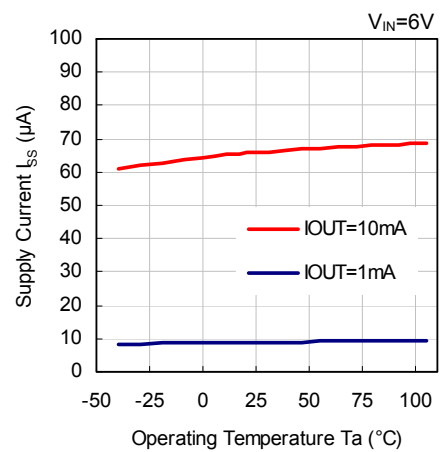

R1155x120B

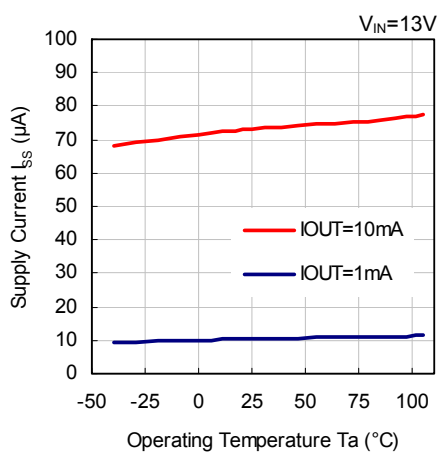

R1155x

NO.EA-270-150702

9) Supply Current vs. Output Current ($C_{IN} = 0.1 \mu F$, $C_{OUT} = 4.7 \mu F$, $T_a = 25^\circ C$)

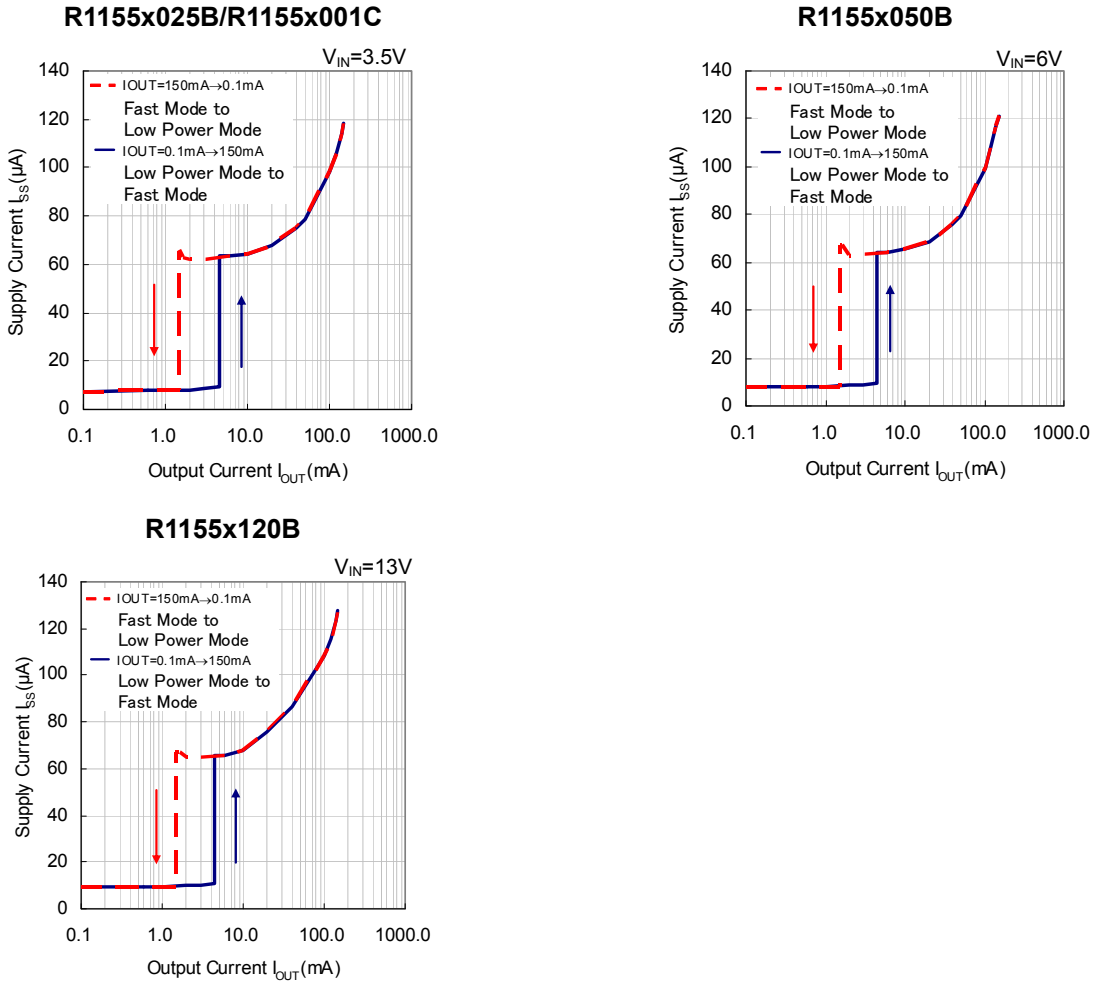

10) Mode Switching Current vs. Operating Temperature ($C_{IN} = 0.1 \mu F$, $C_{OUT} = 4.7 \mu F$)

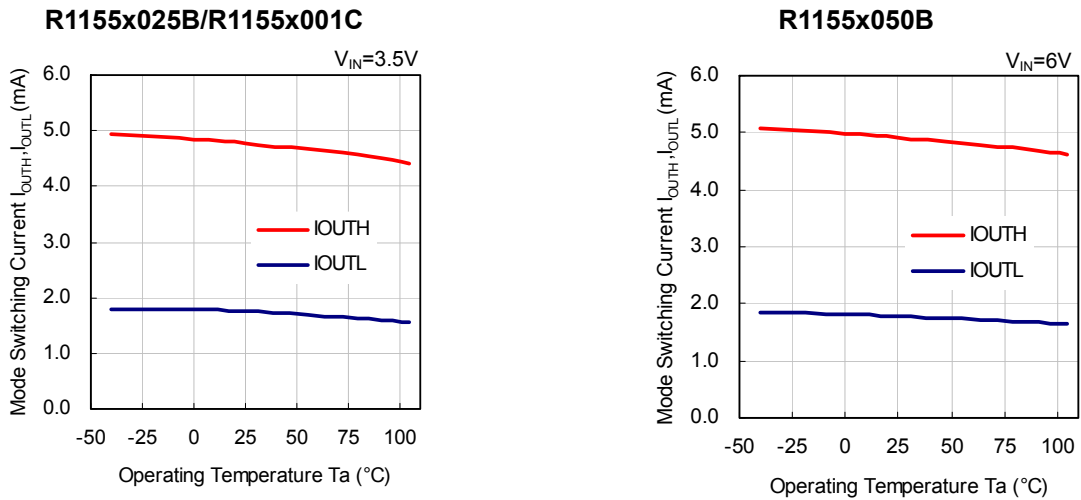

R1155x120B

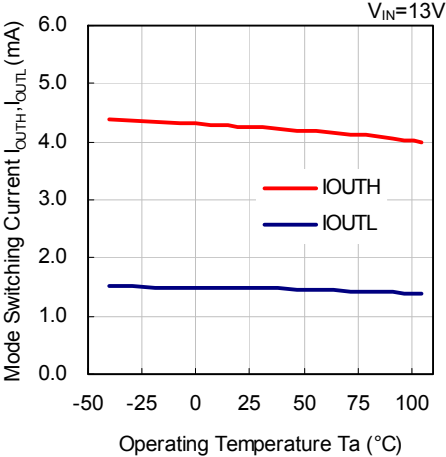

11) Input Transient Response ($C_{OUT} = 4.7 \mu F, T_a = 25^\circ C$)

R1155x025B

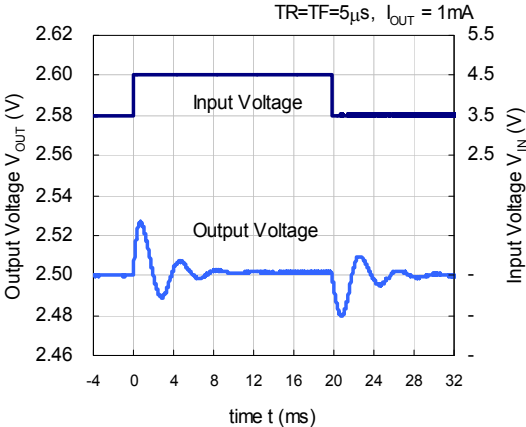

R1155x025B

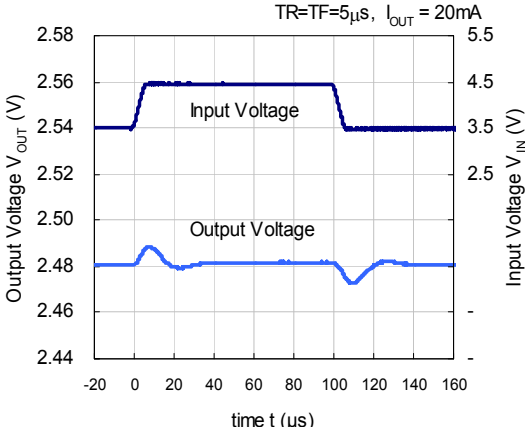

R1155x050B

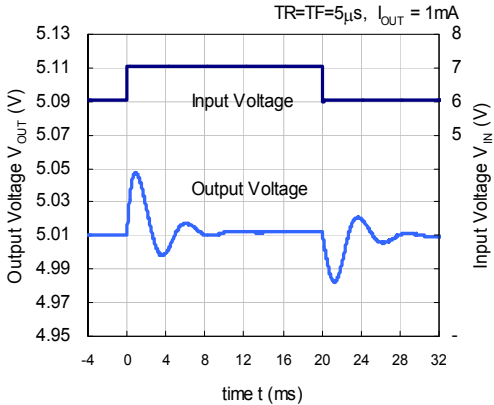

R1155x050B

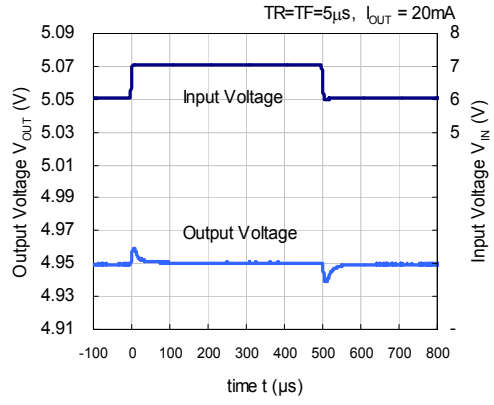

R1155x

NO.EA-270-150702

R1155x120B

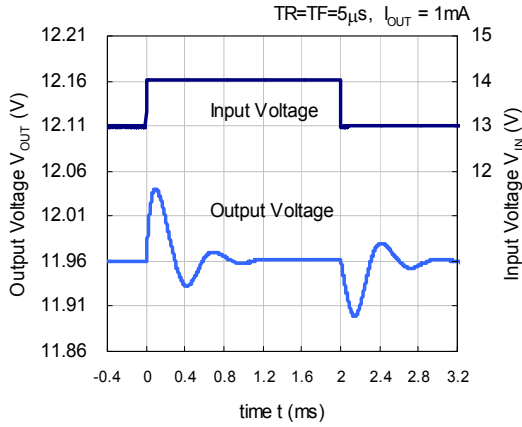

R1155x120B

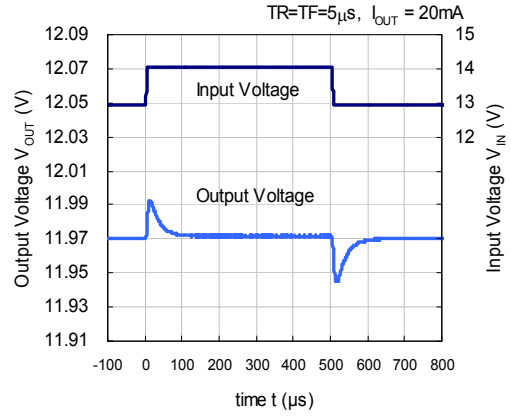

12) Load Transient Response ($C_{OUT} = 4.7 \mu\text{F}$, $T_a = 25^\circ\text{C}$)

R1155x025B

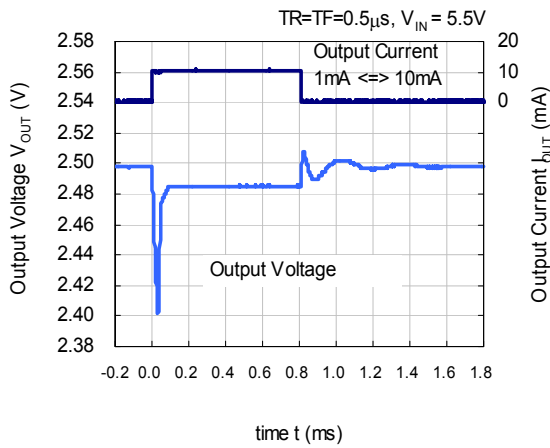

R1155x025B

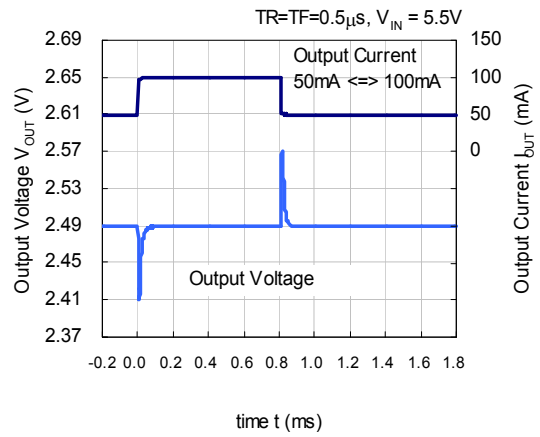

R1155x050B

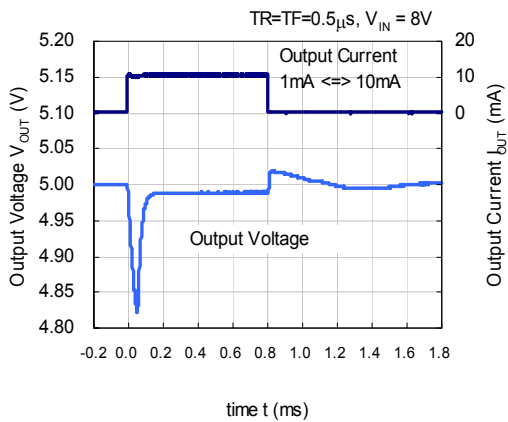

R1155x050B

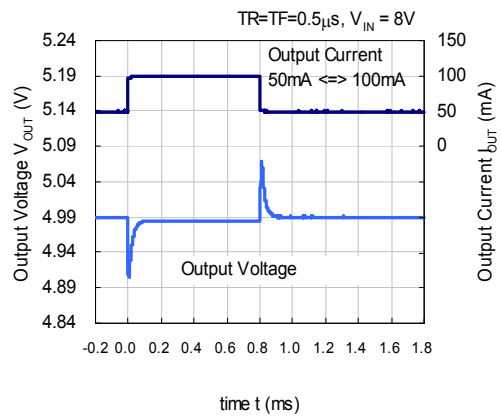

R1155x120B

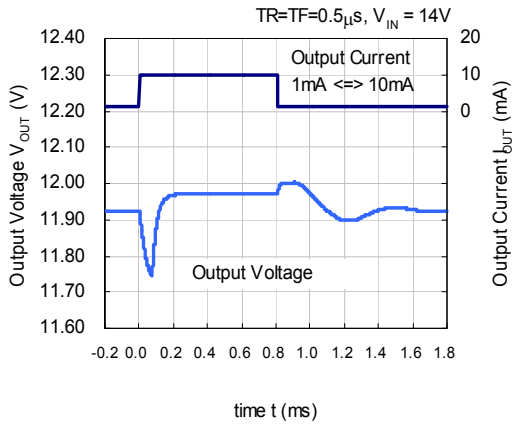

R1155x120B

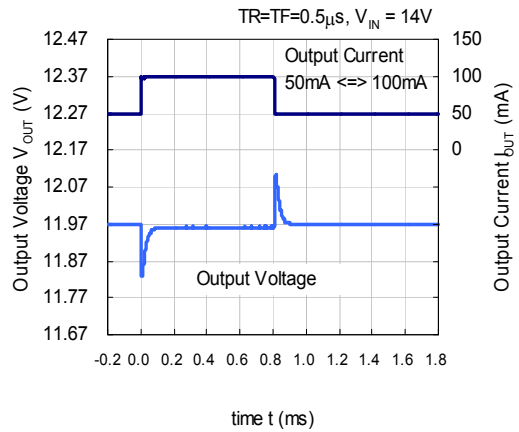

13) CE Input Voltage vs. Output Voltage vs. Inrush Current ($C_{IN} = 0.1 \mu F$, $C_{OUT} = 4.7 \mu F$, $T_a = 25^\circ C$)

R1155x025B

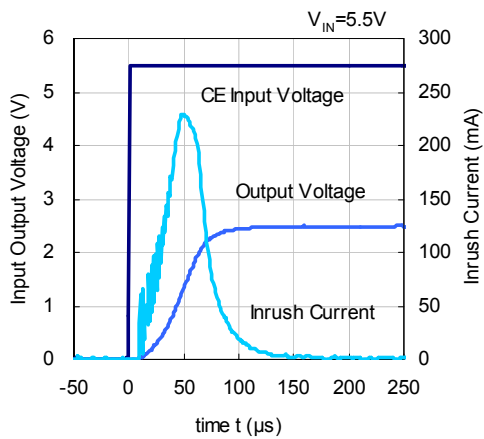

R1155x050B

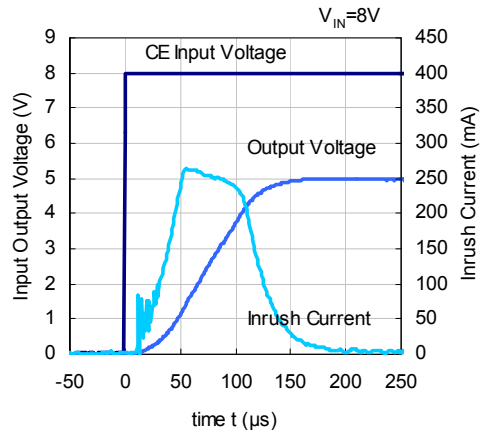

R1155x120B

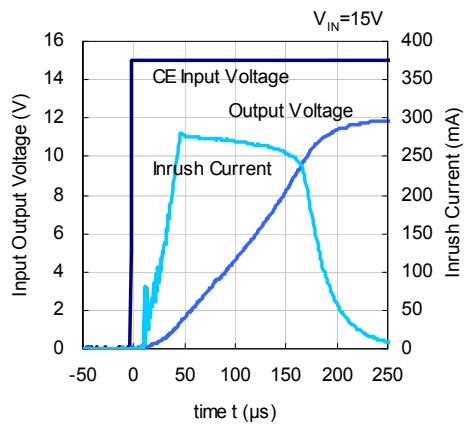

Power Dissipation (P_D) of the package is dependent on PCB material, layout, and environmental conditions. The following conditions are used in this measurement. This data is taken from SOT-23-6.

Measurement Conditions

	Standard Land Pattern
Environment	Mounting on Board (Wind Velocity = 0 m/s)
Board Material	Glass Cloth Epoxy Plastic (Double-sided)
Board Dimensions	40 mm x 40 mm x 1.6 mm
Copper Ratio	Top-side: Approx. 50%, Back-side: Approx. 50%
Through-holes	ϕ 0.5 mm x 44 pcs

Measurement Result

($T_a = 25^\circ\text{C}$, $T_{j\text{max}} = 125^\circ\text{C}$)

	Standard Land Pattern	Free Air
Power Dissipation	420 mW	250 mW
Thermal Resistance	$\theta_{ja} = (125 - 25^\circ\text{C}) / 0.42 \text{ W} = 238^\circ\text{C/W}$	400 $^\circ\text{C/W}$

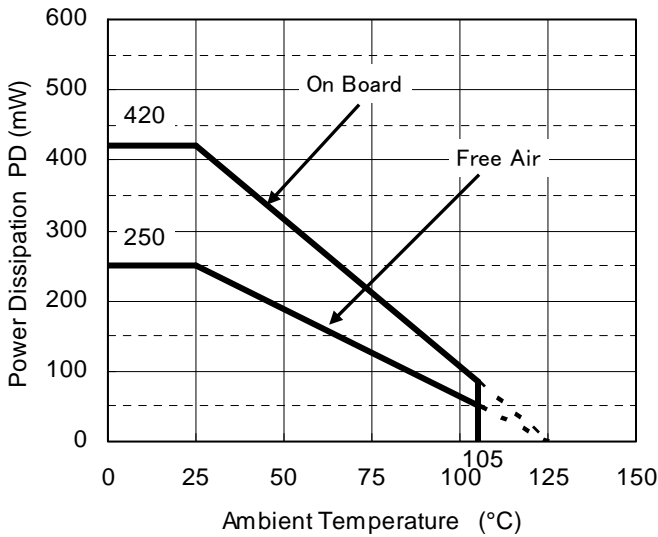

Power Dissipation (mW) vs. Temperature (°C)

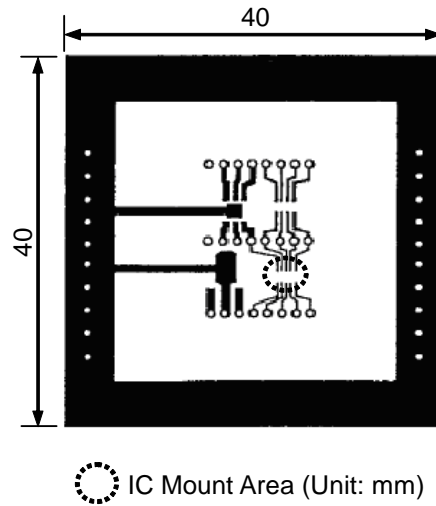

Measurement Board Pattern

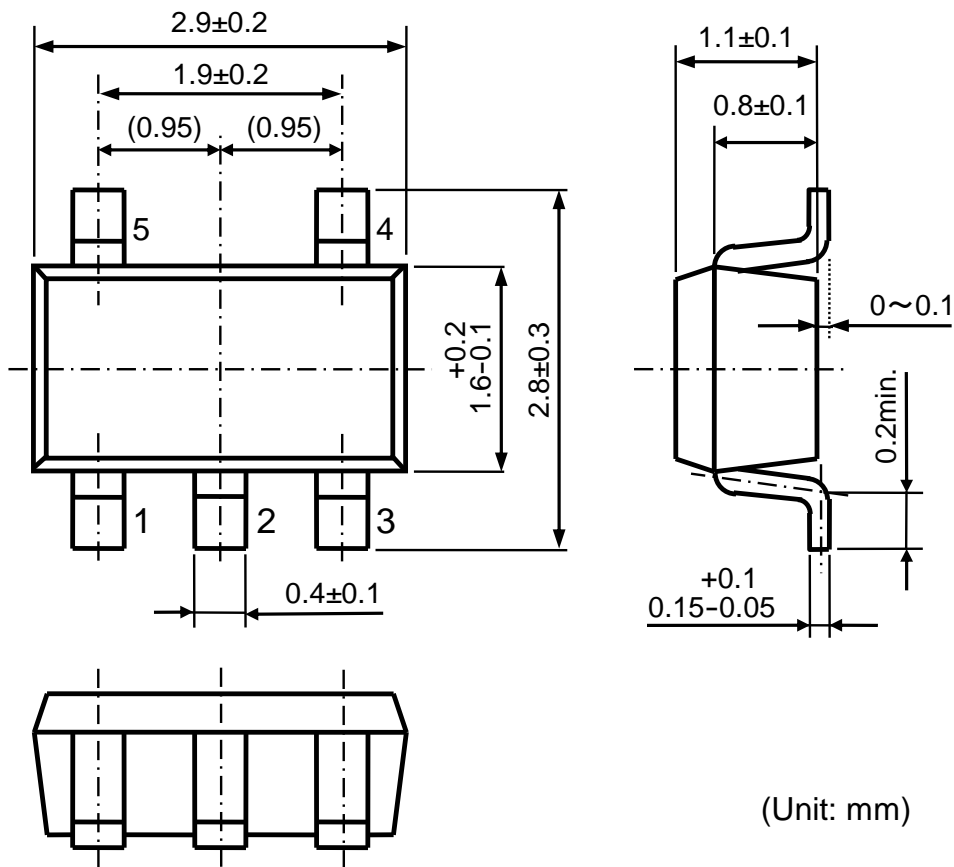

(Unit: mm)

SOT-23-5 Package Dimensions

Power Dissipation (P_D) of the package is dependent on PCB material, layout, and environmental conditions. The following conditions are used in this measurement.

Measurement Conditions

	High Wattage Land Pattern	Standard Land Pattern
Environment	Mounting on Board (Wind Velocity = 0 m/s)	Mounting on Board (Wind Velocity = 0 m/s)
Board Material	Glass Cloth Epoxy Plastic (Double-sided)	Glass Cloth Epoxy Plastic (Double-sided)
Board Dimensions	30 mm x 30 mm x 1.6 mm	50 mm x 50 mm x 1.6 mm
Copper Ratio	Top-side: Approx. 20%, Back-side: Approx. 100%	Top-side: Approx. 10%, Back-side: Approx. 100%
Through-hole	$\phi 0.85$ mm x 10 pcs	-

Measurement Result

($T_a = 25^\circ\text{C}$, $T_{j\text{max}} = 125^\circ\text{C}$)

	High Wattage Land Pattern	Standard Land Pattern	Free Air
Power Dissipation	1300 mW	900 mW	500 mW
Thermal Resistance	77°C/W	111°C/W	200°C/W

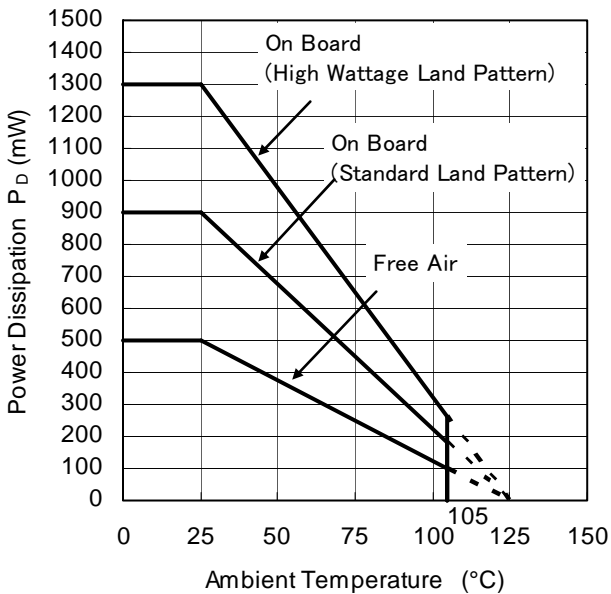

Power Dissipation (mW) vs. Temperature (°C)

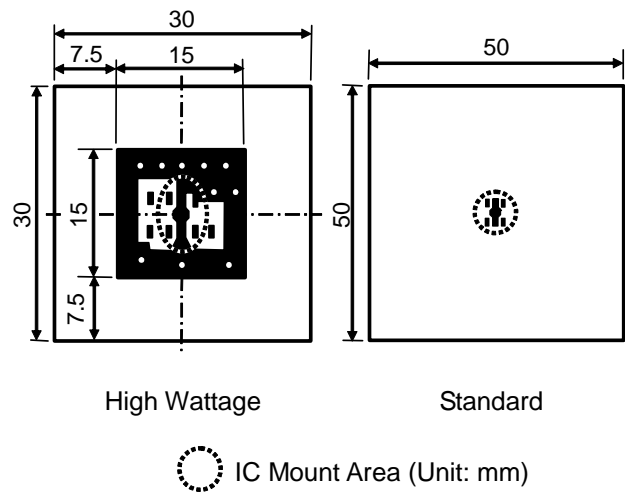

Measurement Board Pattern

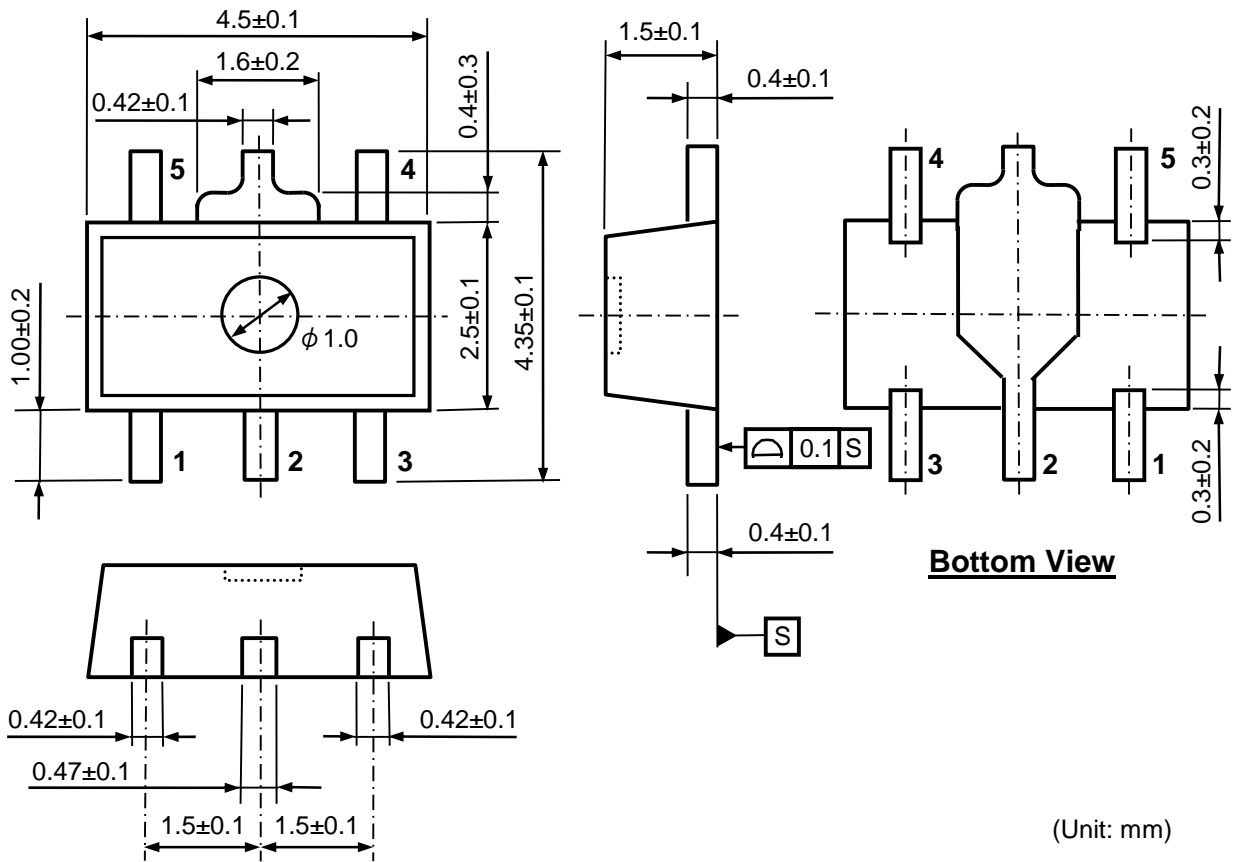

SOT-89-5 Package Dimensions

(Unit: mm)



1. The products and the product specifications described in this document are subject to change or discontinuation of production without notice for reasons such as improvement. Therefore, before deciding to use the products, please refer to Ricoh sales representatives for the latest information thereon.
2. The materials in this document may not be copied or otherwise reproduced in whole or in part without prior written consent of Ricoh.
3. Please be sure to take any necessary formalities under relevant laws or regulations before exporting or otherwise taking out of your country the products or the technical information described herein.
4. The technical information described in this document shows typical characteristics of and example application circuits for the products. The release of such information is not to be construed as a warranty of or a grant of license under Ricoh's or any third party's intellectual property rights or any other rights.
5. The products listed in this document are intended and designed for use as general electronic components in standard applications (office equipment, telecommunication equipment, measuring instruments, consumer electronic products, amusement equipment etc.). Those customers intending to use a product in an application requiring extreme quality and reliability, for example, in a highly specific application where the failure or misoperation of the product could result in human injury or death (aircraft, spacevehicle, nuclear reactor control system, traffic control system, automotive and transportation equipment, combustion equipment, safety devices, life support system etc.) should first contact us.
6. We are making our continuous effort to improve the quality and reliability of our products, but semiconductor products are likely to fail with certain probability. In order to prevent any injury to persons or damages to property resulting from such failure, customers should be careful enough to incorporate safety measures in their design, such as redundancy feature, fire containment feature and fail-safe feature. We do not assume any liability or responsibility for any loss or damage arising from misuse or inappropriate use of the products.
7. Anti-radiation design is not implemented in the products described in this document.
8. Please contact Ricoh sales representatives should you have any questions or comments concerning the products or the technical information.



Ricoh is committed to reducing the environmental loading materials in electrical devices with a view to contributing to the protection of human health and the environment.

Ricoh has been providing RoHS compliant products since April 1, 2006 and Halogen-free products since April 1, 2012.

RICOH RICOH ELECTRONIC DEVICES CO., LTD.

<http://www.e-devices.ricoh.co.jp/en/>

Sales & Support Offices

RICOH ELECTRONIC DEVICES CO., LTD.

Higashi-Shinagawa Office (International Sales)
3-32-3, Higashi-Shinagawa, Shinagawa-ku, Tokyo 140-8655, Japan
Phone: +81-3-5479-2857 Fax: +81-3-5479-0502

RICOH EUROPE (NETHERLANDS) B.V.

Semiconductor Support Centre
Prof. W.H. Keesomlaan 1, 1183 DJ Amstelveen, The Netherlands
Phone: +31-20-5474-309

RICOH ELECTRONIC DEVICES KOREA CO., LTD.

3F, Haesung Bldg. 504, Teheran-ro, Gangnam-gu, Seoul, 135-725, Korea
Phone: +82-2-2135-5700 Fax: +82-2-2051-5713

RICOH ELECTRONIC DEVICES SHANGHAI CO., LTD.

Room 403, No.2 Building, No.690 Bilbo Road, Pu Dong New District, Shanghai 201203,
People's Republic of China
Phone: +86-21-5027-3200 Fax: +86-21-5027-3299

RICOH ELECTRONIC DEVICES CO., LTD.

Taipei office
Room 109, 10F-1, No.51, Hengyang Rd., Taipei City, Taiwan (R.O.C.)
Phone: +886-2-2313-1621/1622 Fax: +886-2-2313-1623