

IRG4PSC71UDPbF

INSULATED GATE BIPOLAR TRANSISTOR WITH
ULTRAFAST SOFT RECOVERY DIODE

UltraFast CoPack IGBT

Features

- Generation 4 IGBT design provides tighter parameter distribution and higher efficiency (minimum switching and conduction losses) than prior generations
- IGBT co-packaged with HEXFRED ultrafast, ultrasoft recovery anti-parallel diodes for use in bridge configurations
- Industry-benchmark Super-247 package with higher power handling capability compared to same footprint TO-247
- Creepage distance increased to 5.35mm
- Lead-Free

Benefits

- Generation 4 IGBT's offer highest efficiencies available
- Maximum power density, twice the power handling of TO-247, less space than TO-264
- IGBTs optimized for specific application conditions
- HEXFRED diodes optimized for performance with IGBTs
- Cost and space saving in designs that require multiple, paralleled IGBTs

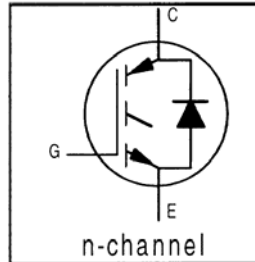

$V_{CES} = 600V$
$V_{CE(on)} \text{ typ.} = 1.67V$
@ $V_{GE} = 15V, I_C = 60A$

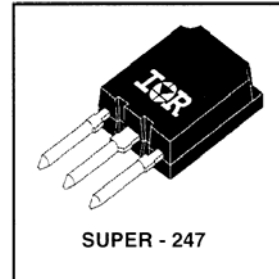

Absolute Maximum Ratings

	Parameter	Max.	Units
V_{CES}	Collector-to-Emitter Voltage	600	V
$I_C @ T_C = 25^\circ C$	Continuous Collector Current	85 ^⑤	A
$I_C @ T_C = 100^\circ C$	Continuous Collector Current	60	
I_{CM}	Pulsed Collector Current ^①	200	
I_{LM}	Clamped Inductive Load Current ^②	200	
$I_F @ T_C = 100^\circ C$	Diode Continuous Forward Current	60	
I_{FM}	Diode Maximum Forward Current	350	
V_{GE}	Gate-to-Emitter Voltage	± 20	V
$P_D @ T_C = 25^\circ C$	Maximum Power Dissipation	350	W
$P_D @ T_C = 100^\circ C$	Maximum Power Dissipation	140	
T_J	Operating Junction and	-55 to +150	$^\circ C$
T_{STG}	Storage Temperature Range		
	Soldering Temperature, for 10 sec.	300 (0.063 in. (1.6mm) from case)	

Thermal Resistance\ Mechanical

	Parameter	Min.	Typ.	Max.	Units
$R_{\theta JC}$	Junction-to-Case - IGBT	—	—	0.36	$^\circ C/W$
$R_{\theta JC}$	Junction-to-Case - Diode	—	—	0.69	
$R_{\theta CS}$	Case-to-Sink, flat, greased surface	—	0.24	—	
$R_{\theta JA}$	Junction-to-Ambient, typical socket mount	—	—	38	
	Recommended Clip Force	20.0(2.0)	—	—	N (kgf)
	Weight	—	6 (0.21)	—	g (oz)

IRG4PSC71UDPbF

International
IR Rectifier

Electrical Characteristics @ $T_J = 25^\circ\text{C}$ (unless otherwise specified)

	Parameter	Min.	Typ.	Max.	Units	Conditions
$V_{(BR)CES}$	Collector-to-Emitter Breakdown Voltage ^③	600	—	—	V	$V_{GE} = 0V, I_C = 250\mu A$
$\Delta V_{(BR)CES}/\Delta T_J$	Temperature Coeff. of Breakdown Voltage	—	0.39	—	V/°C	$V_{GE} = 0V, I_C = 10mA$
$V_{CE(on)}$	Collector-to-Emitter Saturation Voltage	—	1.67	2.0	V	$I_C = 60A, V_{GE} = 15V$ See Fig. 2, 5
		—	1.95	—		
		—	1.71	—		
$V_{GE(th)}$	Gate Threshold Voltage	3.0	—	6.0		$V_{CE} = V_{GE}, I_C = 250\mu A$
$\Delta V_{GE(th)}/\Delta T_J$	Temperature Coeff. of Threshold Voltage	—	-13	—	mV/°C	$V_{CE} = V_{GE}, I_C = 1.5mA$
g_{fe}	Forward Transconductance ^②	47	70	—	S	$V_{CE} = 50V, I_C = 60A$
I_{CES}	Zero Gate Voltage Collector Current	—	—	500	μA	$V_{GE} = 0V, V_{CE} = 600V$
		—	—	13	mA	$V_{GE} = 0V, V_{CE} = 600V, T_J = 150^\circ C$
V_{FM}	Diode Forward Voltage Drop	—	1.4	1.7	V	$I_C = 60A$ See Fig. 13
		—	1.3	—		
I_{GES}	Gate-to-Emitter Leakage Current	—	—	± 100	nA	$V_{GE} = \pm 20V$

Switching Characteristics @ $T_J = 25^\circ\text{C}$ (unless otherwise specified)

	Parameter	Min.	Typ.	Max.	Units	Conditions
Q_g	Total Gate Charge (turn-on)	—	340	520	nC	$I_C = 60A$ $V_{CC} = 400V$ $V_{GE} = 15V$ See Fig. 8
Q_{ge}	Gate - Emitter Charge (turn-on)	—	44	66		
Q_{gc}	Gate - Collector Charge (turn-on)	—	160	240		
$t_{d(on)}$	Turn-On Delay Time	—	90	—	ns	$T_J = 25^\circ C$ $I_C = 60A, V_{CC} = 480V$ $V_{GE} = 15V, R_G = 5.0\Omega$ Energy losses include "tail" and diode reverse recovery. See Fig. 9, 10, 11, 18
t_r	Rise Time	—	94	—		
$t_{d(off)}$	Turn-Off Delay Time	—	245	368		
t_f	Fall Time	—	110	167		
E_{on}	Turn-On Switching Loss	—	3.26	—	mJ	See Fig. 9, 10, 11, 18
E_{off}	Turn-Off Switching Loss	—	2.27	—		
E_{ts}	Total Switching Loss	—	5.53	7.2		
$t_{d(on)}$	Turn-On Delay Time	—	91	—	ns	$T_J = 150^\circ C$, See Fig. 9, 10, 11, 18 $I_C = 60A, V_{CC} = 480V$ $V_{GE} = 15V, R_G = 5.0\Omega$ Energy losses include "tail" and diode reverse recovery.
t_r	Rise Time	—	88	—		
$t_{d(off)}$	Turn-Off Delay Time	—	353	—		
t_f	Fall Time	—	150	—		
E_{ts}	Total Switching Loss	—	7.1	—	mJ	
L_E	Internal Emitter Inductance	—	13	—	nH	Measured 5mm from package
C_{ies}	Input Capacitance	—	7500	—	pF	$V_{GE} = 0V$ $V_{CC} = 30V$ $f = 1.0MHz$ See Fig. 7
C_{oes}	Output Capacitance	—	720	—		
C_{res}	Reverse Transfer Capacitance	—	93	—		
t_{rr}	Diode Reverse Recovery Time	—	82	120	ns	$T_J = 25^\circ C$ See Fig. 14 $T_J = 125^\circ C$
		—	140	210		
I_{rr}	Diode Peak Reverse Recovery Current	—	8.2	12	A	$T_J = 25^\circ C$ See Fig. 15 $T_J = 125^\circ C$
		—	13	20		
Q_{rr}	Diode Reverse Recovery Charge	—	364	546	nC	$T_J = 25^\circ C$ See Fig. 16 $T_J = 125^\circ C$
		—	1084	1625		
$di_{(rec)M}/dt$ During t_b	Diode Peak Rate of Fall of Recovery	—	328	—	A/ μs	$T_J = 25^\circ C$ See Fig. 17 $T_J = 125^\circ C$
		—	266	—		

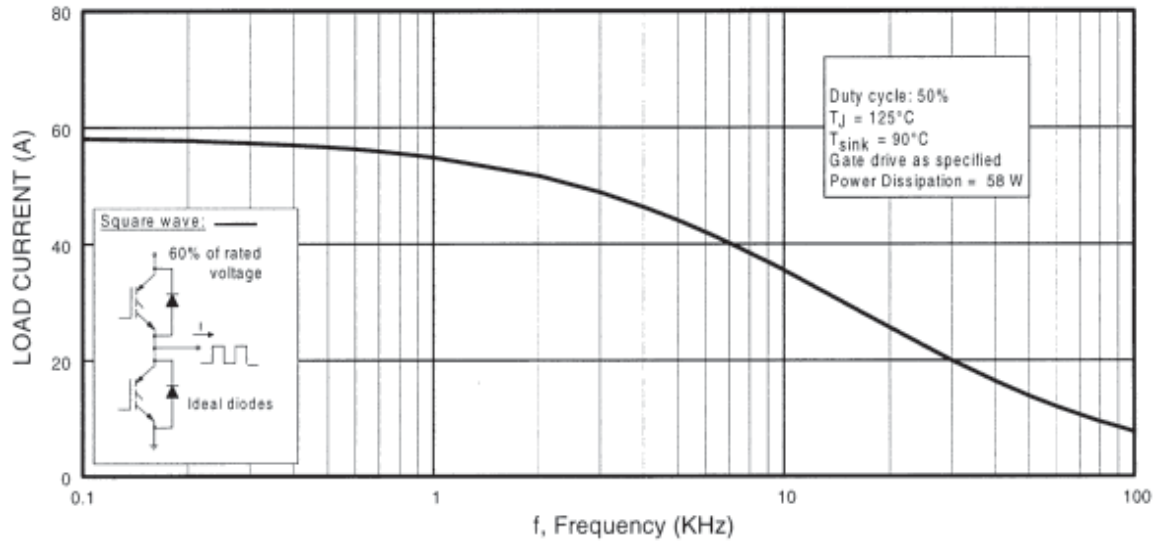

Fig. 1 - Typical Load Current vs. Frequency
 (Load Current = I_{RMS} of fundamental)

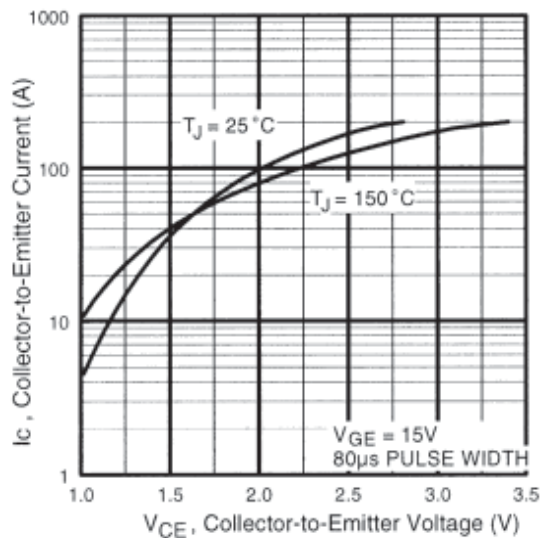

Fig. 2 - Typical Output Characteristics
www.irf.com

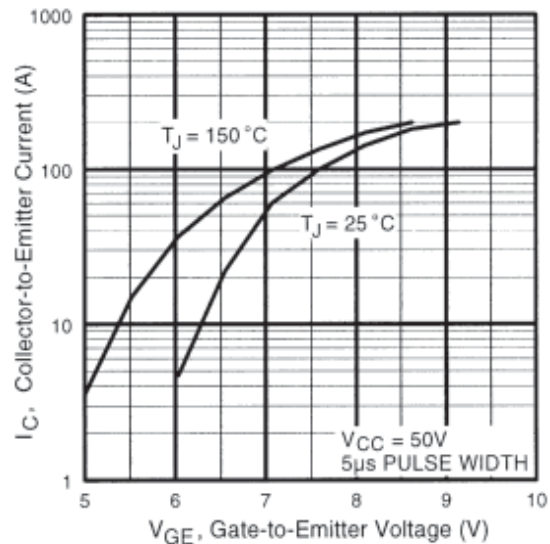

Fig. 3 - Typical Transfer Characteristics

IRG4PSC71UDPbF

International
IR Rectifier

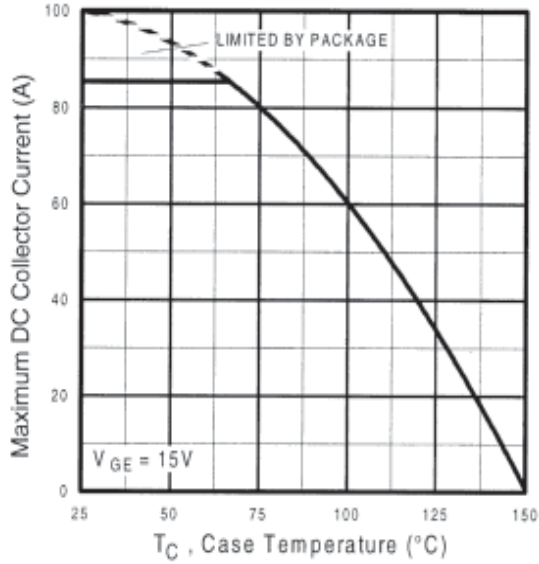

Fig. 4 - Maximum Collector Current vs. Case Temperature

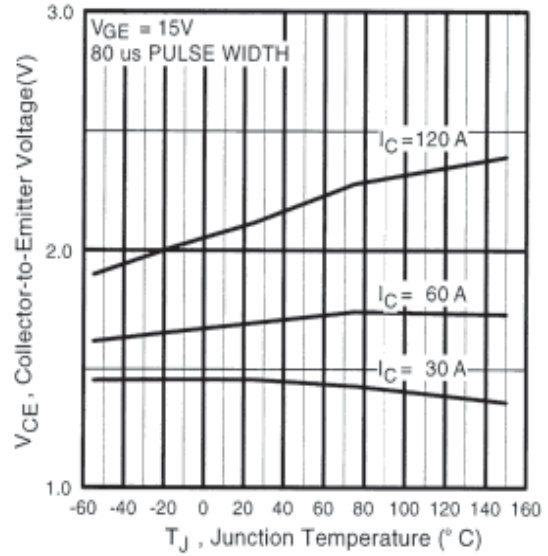

Fig. 5 - Typical Collector-to-Emitter Voltage vs. Junction Temperature

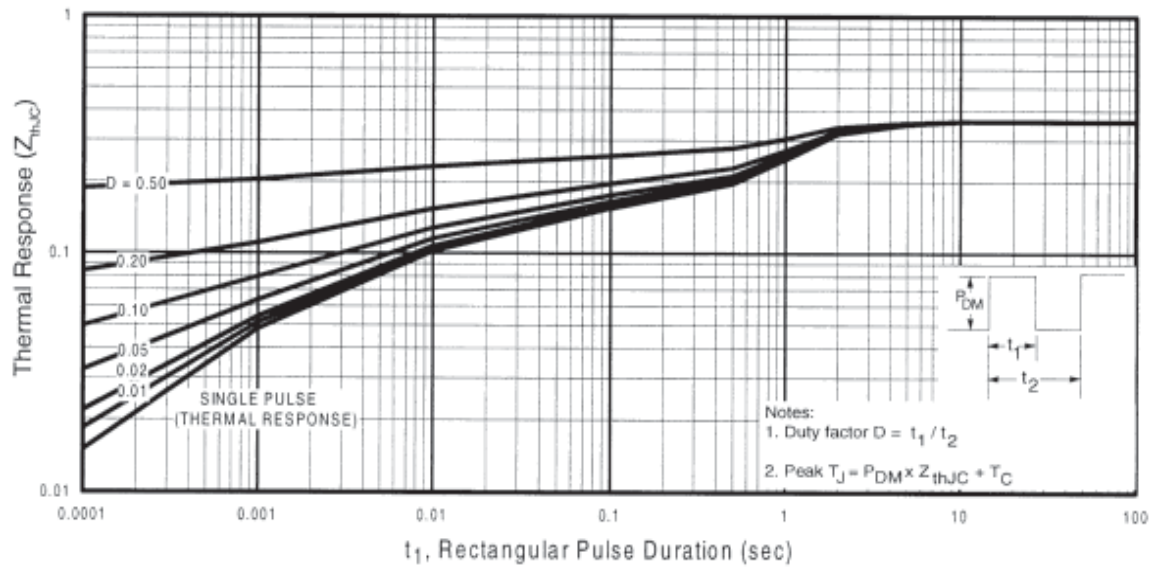

Fig. 6 - Maximum IGBT Effective Transient Thermal Impedance, Junction-to-Case

IRG4PSC71UDPbF

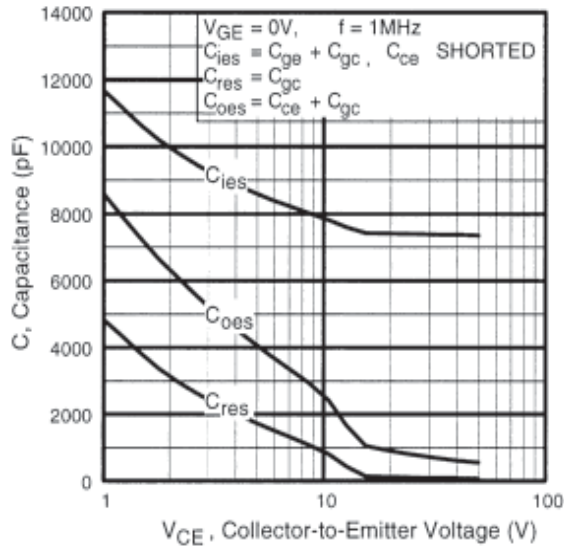

Fig. 7 - Typical Capacitance vs. Collector-to-Emitter Voltage

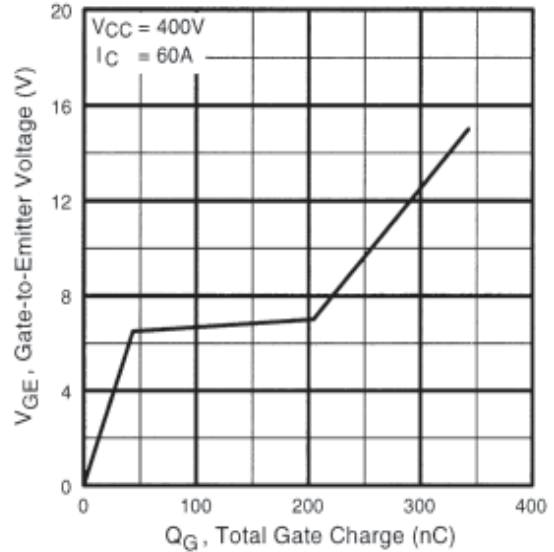

Fig. 8 - Typical Gate Charge vs. Gate-to-Emitter Voltage

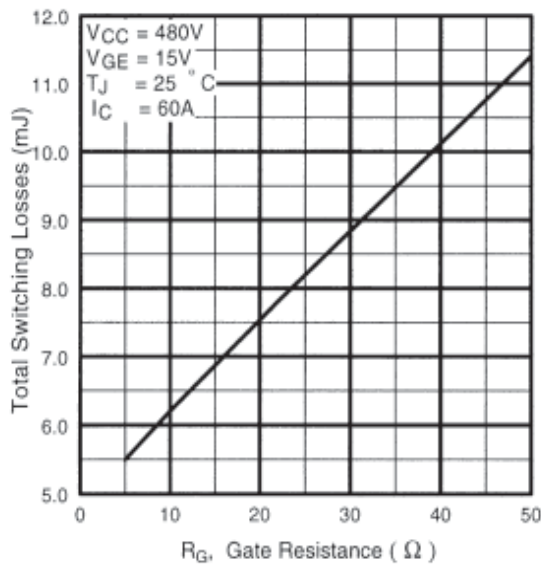

Fig. 9 - Typical Switching Losses vs. Gate Resistance

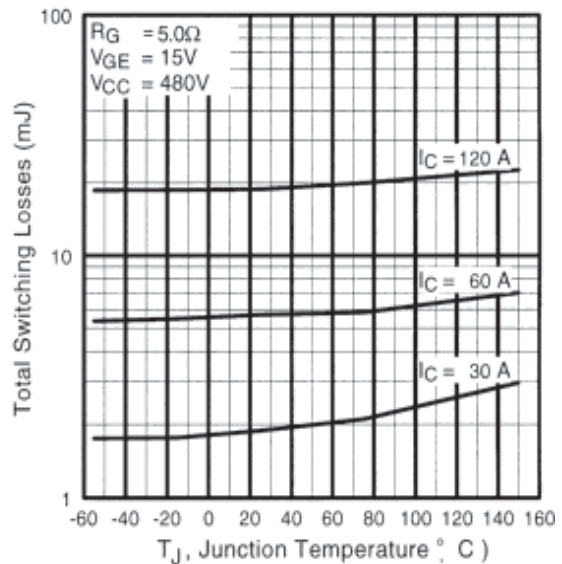

Fig. 10 - Typical Switching Losses vs. Junction Temperature

IRG4PSC71UDPbF

International
IR Rectifier

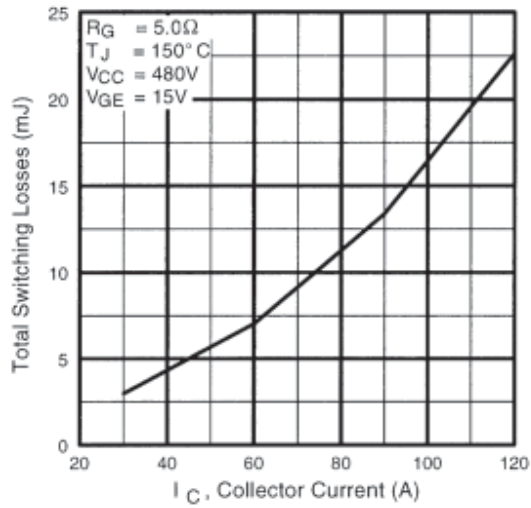

Fig. 11 - Typical Switching Losses vs. Collector-to-Emitter Current

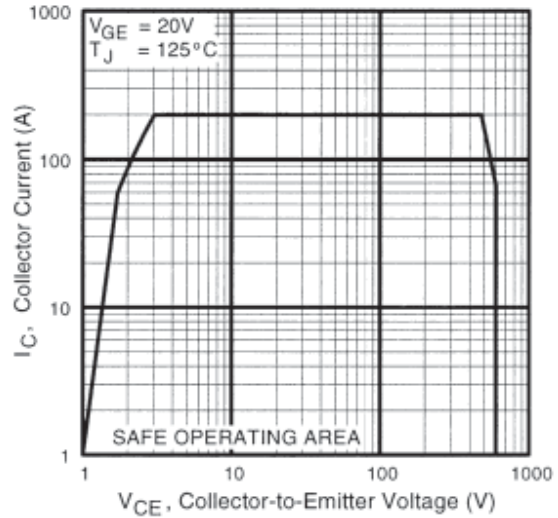

Fig. 12 - Turn-Off SOA

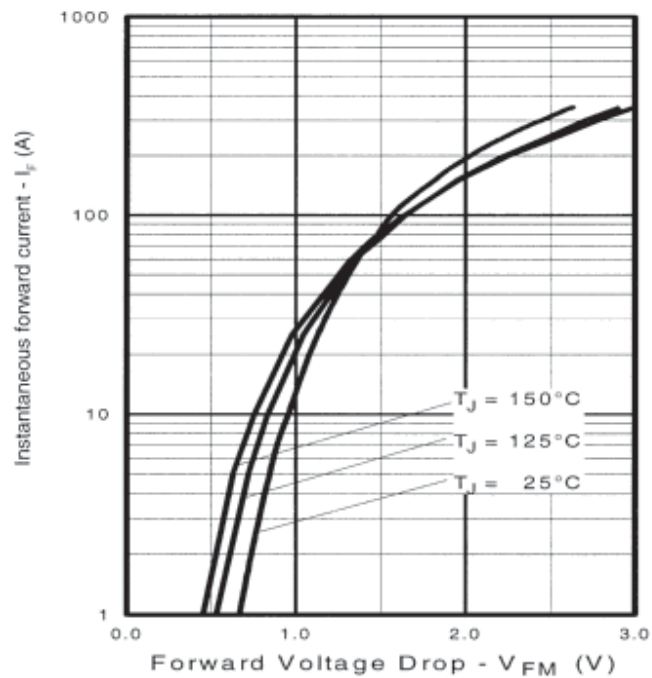

Fig. 13 - Maximum Forward Voltage Drop vs. Instantaneous Forward Current

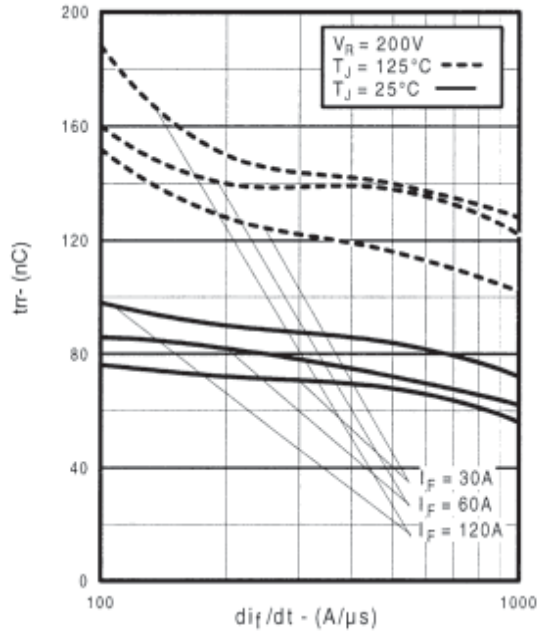

Fig. 14 - Typical Reverse Recovery vs. di_f/dt

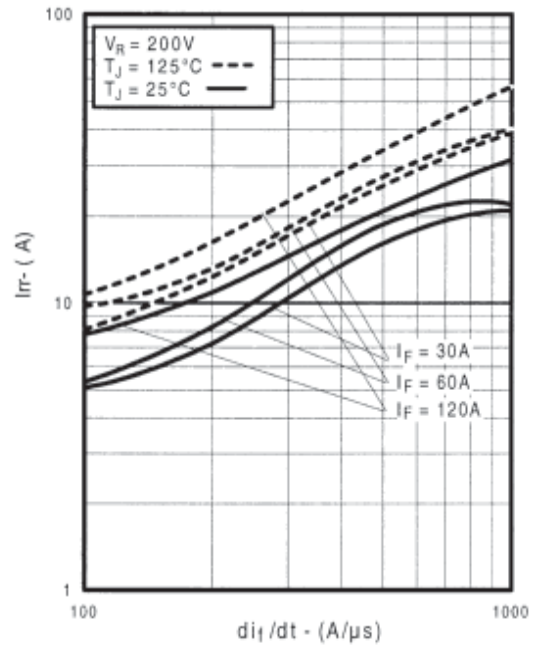

Fig. 15 - Typical Recovery Current vs. di_f/dt

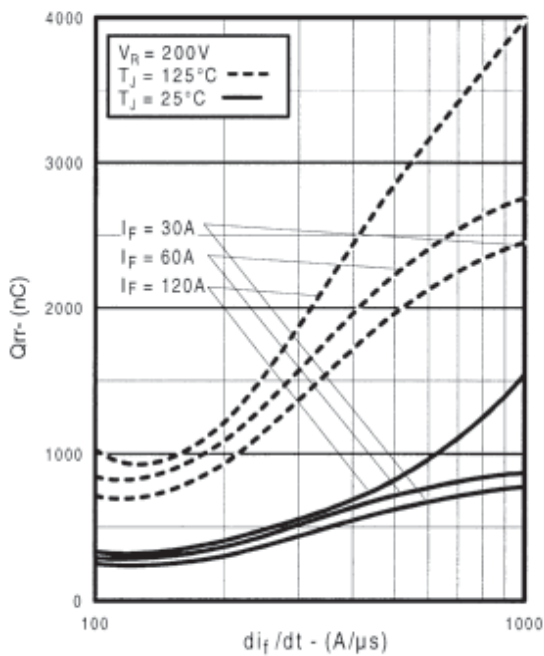

Fig. 16 - Typical Stored Charge vs. di_f/dt
www.irf.com

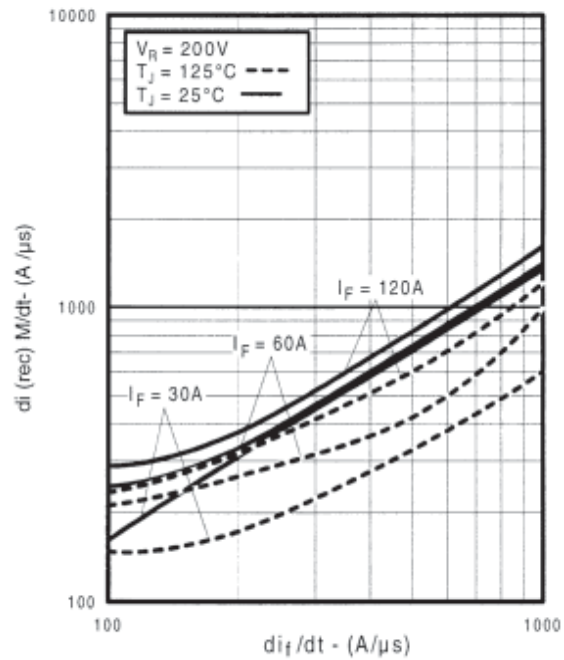

Fig. 17 - Typical $di_{(rec)M}/dt$ vs. di_f/dt

IRG4PSC71UDPbF

International
IR Rectifier

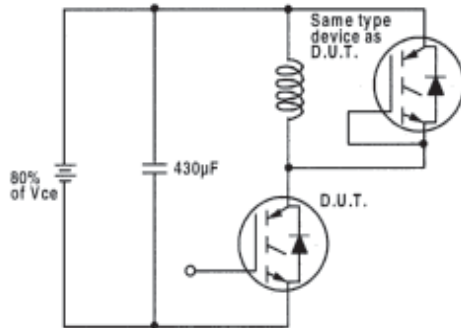

Fig. 18a - Test Circuit for Measurement of I_{LM} , E_{on} , $E_{off}(\text{diode})$, t_{rr} , Q_{rr} , I_{rr} , $t_{d(on)}$, t_r , $t_{d(off)}$, t_f

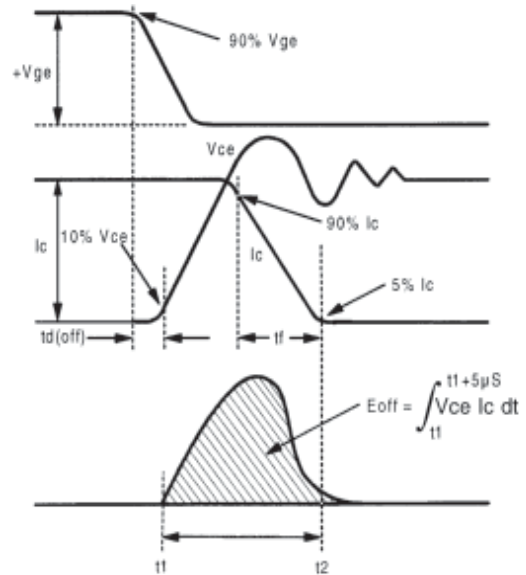

Fig. 18b - Test Waveforms for Circuit of Fig. 18a, Defining E_{off} , $t_{d(off)}$, t_f

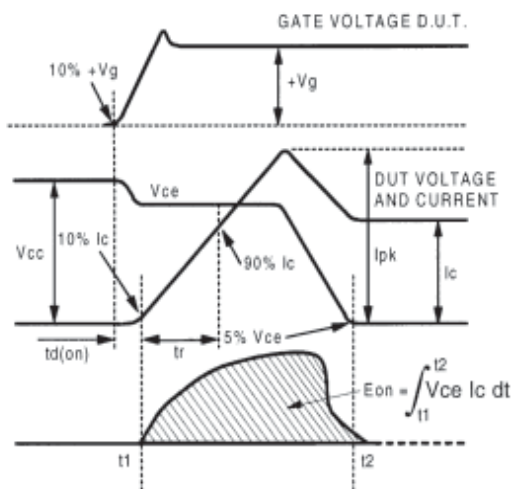

Fig. 18c - Test Waveforms for Circuit of Fig. 18a, Defining E_{on} , $t_{d(on)}$, t_r

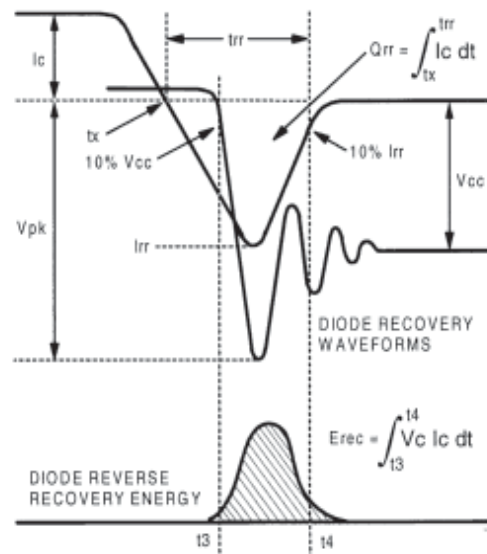

Fig. 18d - Test Waveforms for Circuit of Fig. 18a, Defining E_{rec} , t_{tr} , Q_{rr} , I_{rr}

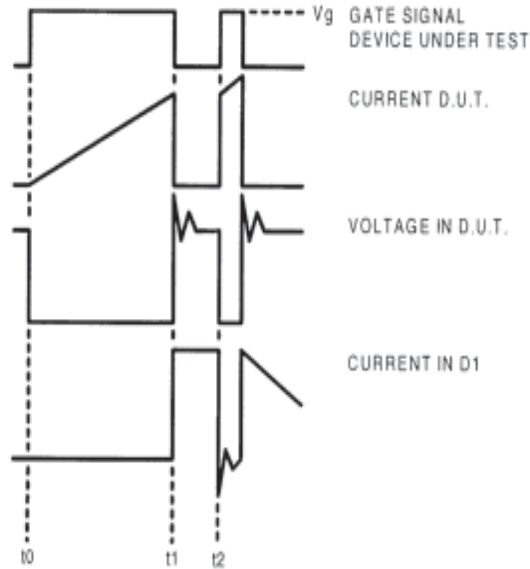

Figure 18e. Macro Waveforms for Figure 18a's Test Circuit

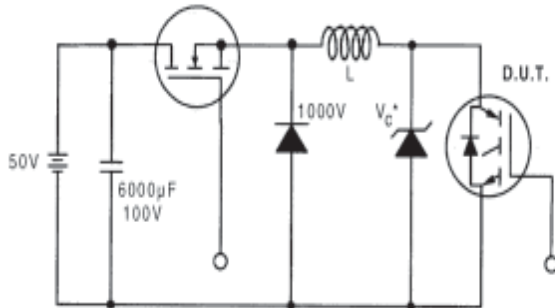

Figure 19. Clamped Inductive Load Test Circuit

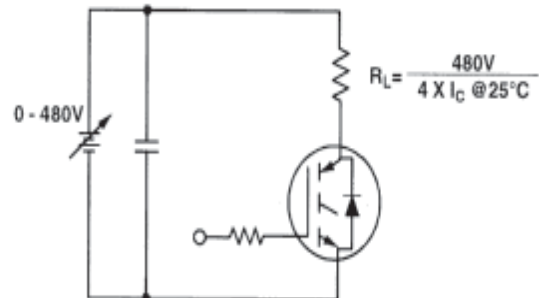

Figure 20. Pulsed Collector Current Test Circuit

Notes:

- ① Repetitive rating: $V_{GE}=20V$; pulse width limited by maximum junction temperature (figure 20)
- ② $V_{CC}=80\%(V_{CES})$, $V_{GE}=20V$, $L=10\mu H$, $R_G= 5.0\Omega$ (figure 19)
- ③ Pulse width $\leq 80\mu s$; duty factor $\leq 0.1\%$
- ④ Pulse width $5.0\mu s$, single shot
- ⑤ Current limited by the package, (Die current = 100A)

IRG4PSC71UDPbF

Case Outline and Dimensions — Super-247

International
IR Rectifier

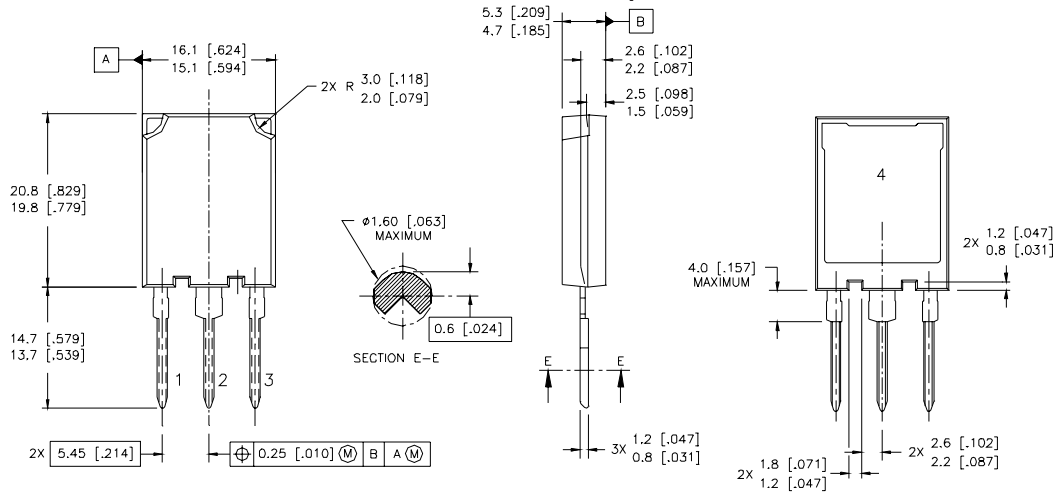

NOTES:

1. DIMENSIONS & TOLERANCING PER ASME Y14.5M-1994
2. CONTROLLING DIMENSION: MILLIMETER
3. DIMENSIONS ARE SHOWN IN MILLIMETRES [INCHES]

LEAD ASSIGNMENTS

MOSFET	IGBT
1 - GATE	1 - GATE
2 - DRAIN	2 - COLLECTOR
3 - SOURCE	3 - EMITTER
4 - DRAIN	4 - COLLECTOR

Super-247 (TO-274AA) Part Marking Information

EXAMPLE: THIS IS AN IRFPS37N50A WITH
ASSEMBLY LOT CODE 1789
ASSEMBLED ON WW 19, 1997
IN THE ASSEMBLY LINE "C"

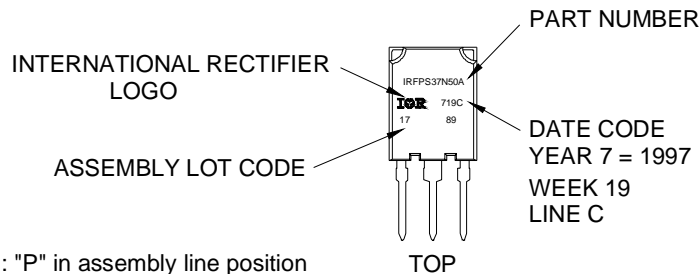

Note: "P" in assembly line position indicates "Lead-Free"

Data and specifications subject to change without notice.

International
IR Rectifier

IR WORLD HEADQUARTERS: 233 Kansas St., El Segundo, California 90245, USA Tel: (310) 252-7105
TAC Fax: (310) 252-7903

Visit us at www.irf.com for sales contact information. 09/04

www.irf.com