

## Features

- Ideal for automated placement
- Glass passivated fast recovery rectifiers
- High reverse voltage
- High forward surge capability
- Moisture sensitivity: level 1, per J-STD-020

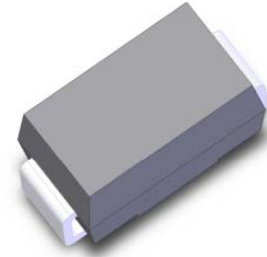

DO-214AC(SMA)

## Typical Applications

- For use of general purpose rectification in lighting, cellular phone, portable device, power supplies and other consumer applications.

## Mechanical Data

- Case:DO-214AC, molded epoxy body, Epoxy meets UL 94V-0 flammability rating
- Terminal:Matte tin plated leads, solderable per J-STD-002 and JESD22B-106
- Polarity:Indicated by cathode band

Maximum Ratings and Electrical Characteristics			
(TA = 25 °C unless otherwise noted)			
Parameter	Symbol	GRZ520	Unit
Maximum repetitive peak reverse voltage	VRRM	2000	V
Maximum RMS voltage	VRMS	1400	V
Maximum DC blocking voltage	VDC	2000	V
Maximum average forward rectified current TL (See Fig.1)	IF(AV)	0.5	A
Peak forward surge current 8.3 ms single half sine-wave superimposed on rated load	IFSM	25.0	A
Maximum forward voltage at IF=0.5Amps	VF	1.7	Volts
Maximum DC reverse current at rated DC blocking	IR	@Ta=25°C	5.0
		@Ta=125°C	250.0
Maximum reverse recovery time	t <sub>rr</sub>	300	nS
Typical junction capacitance(Note1)	C <sub>J</sub>	5.0	pF
Typical thermal resistance(Note2)	R <sub>θJA</sub>	TBD	°C/W
Operating junction and storage temperature range	T <sub>J</sub> , T <sub>STG</sub>	- 55 to + 150	°C

Notes:1.Measured at 1.0MHz and applied reverse voltage of 4.0 D.C.

2.Thermal resistance from junction to ambient, 8.0×8.0mm copper pads to each terminal

## Ratings and Characteristics Curves

(TA = 25°C unless otherwise noted)

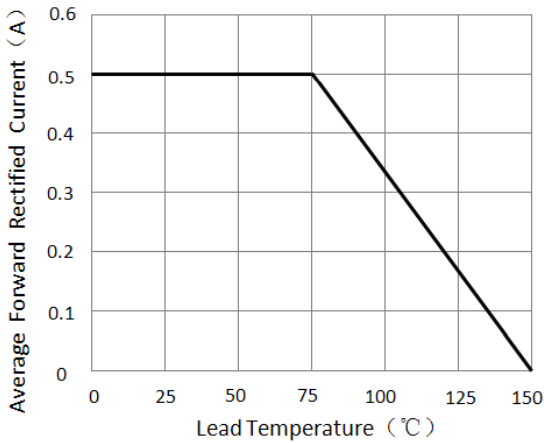

Figure 1. Forward Current Derating Curve

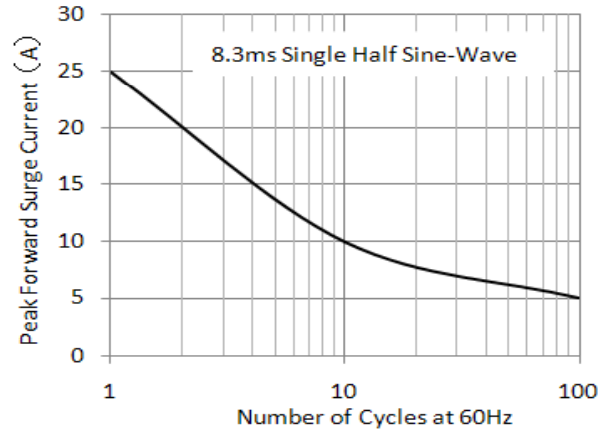

Figure 2. Maximum Non-Repetitive Peak Forward Surge Current

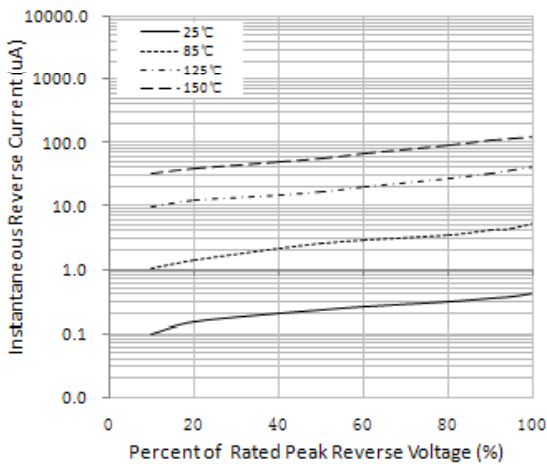

Figure 3. Typical Reverse Characteristics

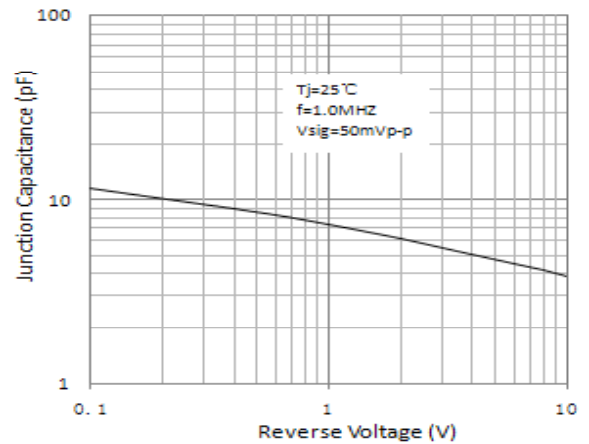

Figure 4. Typical Junction Capacitance

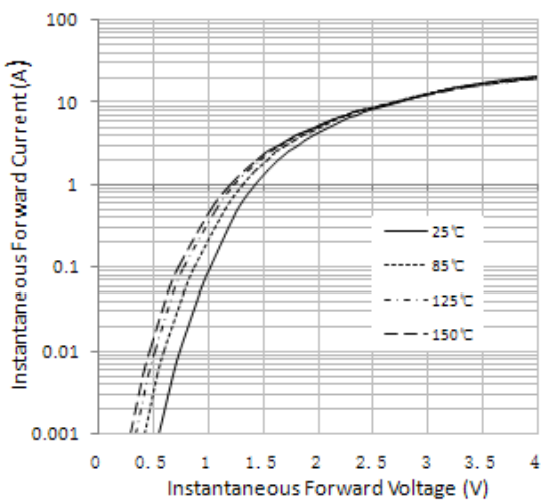
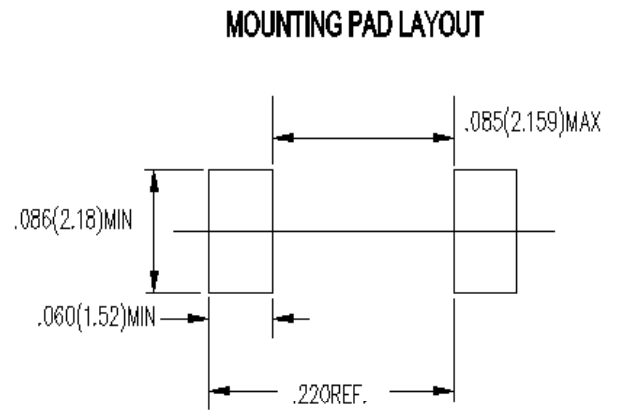
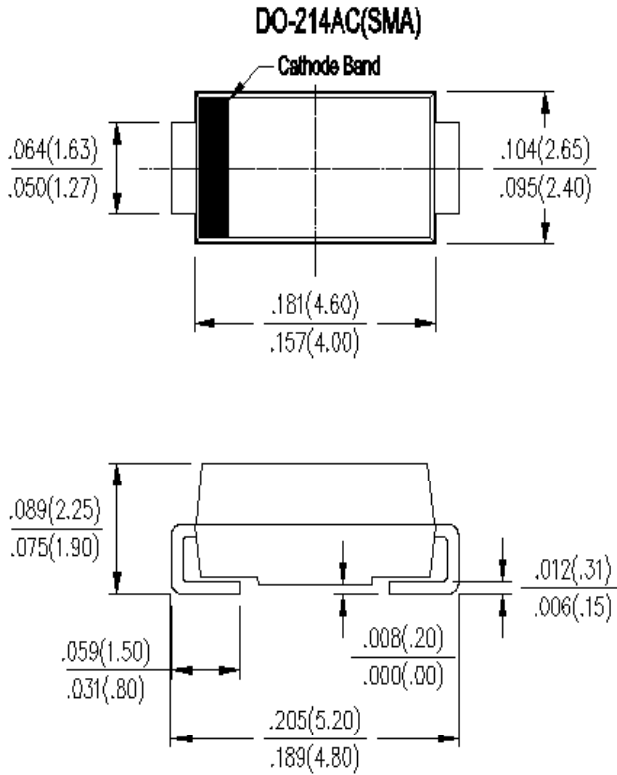

Figure 5. Typical Instantaneous Forward Characteristics

## Package Outline Dimensions

in inches (millimeters)





## Disclaimers

These materials are intended as a reference to assist our customers in the selection of the Suzhou Good-Ark product best suited to the customer's application; they do not convey any license under any intellectual property rights, or any other rights, belonging to Suzhou Good-Ark Electronics Co., Ltd. or a third party.

Suzhou Good-Ark Electronics Co., Ltd. assumes no responsibility for any damage, or infringement of any third-party's rights, originating in the use of any product data, diagrams, charts, programs, algorithms, or circuit application examples contained in these materials.

All information contained in these materials, including product data, diagrams, charts, programs and algorithms represents information on products at the time of publication of these materials, and are subject to change by Suzhou Good-Ark Electronics Co., Ltd. without notice due to product improvements or other reasons. It is therefore recommended that customers contact Suzhou Good-Ark Electronics Co., Ltd. or an authorized Suzhou Good-Ark Electronics Co., Ltd. for the latest product information before purchasing a product listed herein. The information described here may contain technical inaccuracies or typographical errors. Suzhou Good-Ark Electronics Co., Ltd. assumes no responsibility for any damage, liability, or other loss rising from these inaccuracies or errors. Please also pay attention to information published by Suzhou Good-Ark Electronics Co., Ltd. by various means, including our website home page. (<http://www.goodark.com>)

When using any or all of the information contained in these materials, including product data, diagrams, charts, programs, and algorithms, Please be sure to evaluate all information as a total system before making a final decision on the applicability of the information and products. Suzhou Good-Ark Electronics Co., Ltd. assumes no responsibility for any damage, liability or other loss resulting from the information contained herein.

The prior written approval of Suzhou Good-Ark Electronics Co., Ltd. is necessary to reprint or reproduce in whole or in part these materials.

Please contact Suzhou Good-Ark Electronics Co., Ltd. or an authorized distributor for further details on these materials or the products contained herein.