

Ceramic, Safety, C900\_Y, 1500 pF, 20%, Y5U, Lead Spacing = 7.5mm

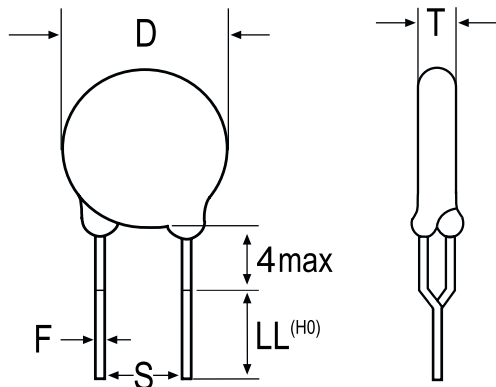

General Information	
Style:	Radial Disc
Series:	C900_Y
RoHS:	Yes
Termination:	Tin
Failure Rate:	N/A
Safety Class:	X1/Y2
Approvals:	UL, ENEC, CSA
Halogen Free:	Yes

Dimensions	
D	9mm MAX
T	5mm MAX
S	7.5mm +/-1mm
LL	18mm +2/-0mm
F	0.55mm +/-0.1mm

Specifications	
Capacitance:	1500 pF
Capacitance Tolerance:	20%
Voltage:	400 VAC (X), 250 VAC (Y)
Dielectric Withstanding Voltage:	2,600 V
Temperature Range:	-40/+125C
Temperature Coefficient:	Y5U
Dissipation Factor:	2.5%
Insulation Resistance:	10 GOhms

Packaging Specifications	
Packaging:	Ammo, H0 = 18mm, Component Pitch = 15mm
Packaging Quantity:	1000