

# HAT2215R

## Silicon N Channel Power MOSFET High Speed Power Switching

REJ03G0486-0301  
Rev.3.01  
Jan 20, 2017

### Features

- Low on-resistance
- Capable of 4.5 V gate drive
- High density mounting

### Outline

RENESAS Package code: PRSP0008DD-D  
(Package name: SOP-8<FP-8DAV>)

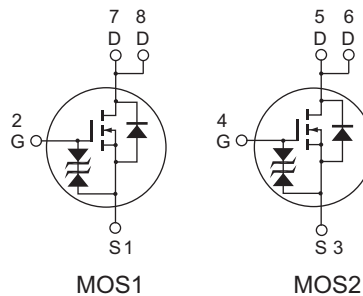
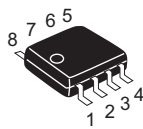

1, 3 Source  
2, 4 Gate  
5, 6, 7, 8 Drain

### Absolute Maximum Ratings

(Ta = 25°C)

Item	Symbol	Ratings	Unit
Drain to source voltage	V <sub>DSS</sub>	80	V
Gate to source voltage	V <sub>GSS</sub>	±20	V
Drain current	I <sub>D</sub>	3.4	A
Drain peak current	I <sub>D(pulse)</sub> <sup>Note1</sup>	20.4	A
Reverse drain current	I <sub>DR</sub>	3.4	A
Channel dissipation	P <sub>ch</sub> <sup>Note2</sup>	1.5	W
Channel dissipation	P <sub>ch</sub> <sup>Note3</sup>	2.2	W
Channel temperature	T <sub>ch</sub>	150	°C
Storage temperature	T <sub>stg</sub>	-55 to +150	°C

Notes: 1. PW ≤ 10 μs, duty cycle ≤ 1%

2. 1 Drive operation; When using the glass epoxy board (FR4 40 x 40 x 1.6 mm), PW ≤ 10 s

3. 2 Drive operation; When using the glass epoxy board (FR4 40 x 40 x 1.6 mm), PW ≤ 10 s

## Electrical Characteristics

(Ta = 25°C)

Item	Symbol	Min	Typ	Max	Unit	Test Conditions
Drain to source breakdown voltage	$V_{(BR)DSS}$	80	—	—	V	$I_D = 10 \text{ mA}$ , $V_{GS} = 0$
Gate to source breakdown voltage	$V_{(BR)GSS}$	$\pm 20$	—	—	V	$I_D = \pm 100 \text{ }\mu\text{A}$ , $V_{GS} = 0$
Gate to source leak current	$I_{GSS}$	—	—	$\pm 10$	$\mu\text{A}$	$V_{GS} = \pm 16 \text{ V}$ , $V_{DS} = 0$
Zero gate voltage drain current	$I_{DSS}$	—	—	1	$\mu\text{A}$	$V_{DS} = 80 \text{ V}$ , $V_{GS} = 0$
Gate to source cutoff voltage	$V_{GS(off)}$	1.0	—	2.5	V	$V_{DS} = 10 \text{ V}$ , $I_D = 1 \text{ mA}$
Static drain to source on state resistance	$R_{DS(on)}$	—	88	115	$\text{m}\Omega$	$I_D = 1.7 \text{ A}$ , $V_{GS} = 10 \text{ V}$ <sup>Note4</sup>
	$R_{DS(on)}$	—	100	145	$\text{m}\Omega$	$I_D = 1.7 \text{ A}$ , $V_{GS} = 4.5 \text{ V}$ <sup>Note4</sup>
Forward transfer admittance	$ y_{fs} $	4.2	7.0	—	S	$I_D = 1.7 \text{ A}$ , $V_{DS} = 10 \text{ V}$ <sup>Note4</sup>
Input capacitance	$C_{iss}$	—	400	—	pF	$V_{DS} = 10 \text{ V}$
Output capacitance	$C_{oss}$	—	57	—	pF	$V_{GS} = 0$
Reverse transfer capacitance	$C_{rss}$	—	24	—	pF	$f = 1 \text{ MHz}$
Total gate charge	$Q_g$	—	7.3	—	nC	$V_{DD} = 25 \text{ V}$
Gate to source charge	$Q_{gs}$	—	1.1	—	nC	$V_{GS} = 10 \text{ V}$
Gate to drain charge	$Q_{gd}$	—	1.3	—	nC	$I_D = 3.4 \text{ A}$
Turn-on delay time	$t_{d(on)}$	—	6.0	—	ns	$V_{GS} = 10 \text{ V}$ , $I_D = 1.7 \text{ A}$
Rise time	$t_r$	—	4.0	—	ns	$V_{DD} \approx 30 \text{ V}$
Turn-off delay time	$t_{d(off)}$	—	39	—	ns	$R_L = 17.6 \text{ }\Omega$
Fall time	$t_f$	—	3.5	—	ns	$R_g = 4.7 \text{ }\Omega$
Body-drain diode forward voltage	$V_{DF}$	—	0.83	1.08	V	$I_F = 3.4 \text{ A}$ , $V_{GS} = 0$ <sup>Note4</sup>
Body-drain diode reverse recovery time	$t_{rr}$	—	30	—	ns	$I_F = 3.4 \text{ A}$ , $V_{GS} = 0$ $di_F/dt = 100 \text{ A}/\mu\text{s}$

Notes: 4. Pulse test

Main Characteristics

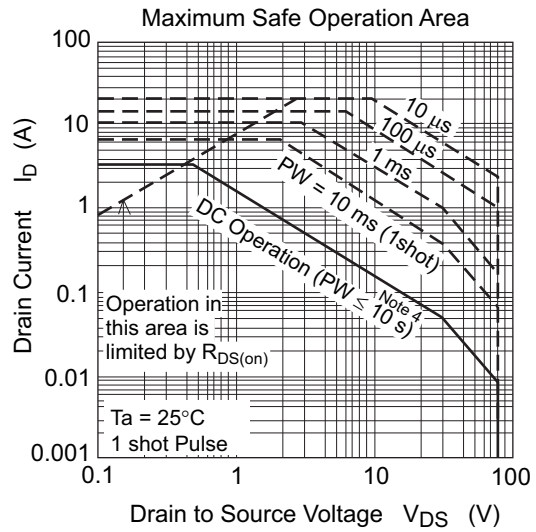
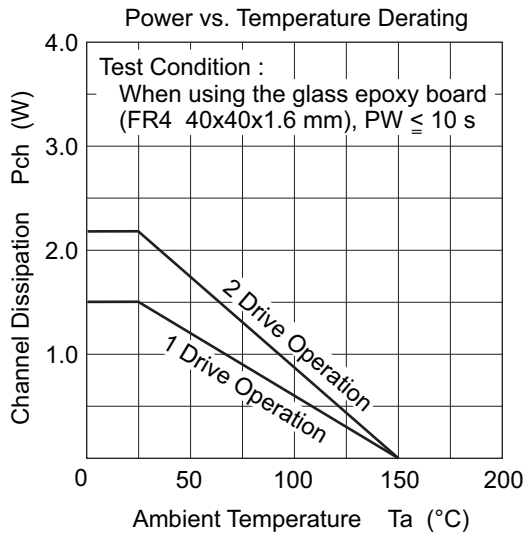

Note 5 :  
When using the glass epoxy board (FR4 40x40x1.6 mm)

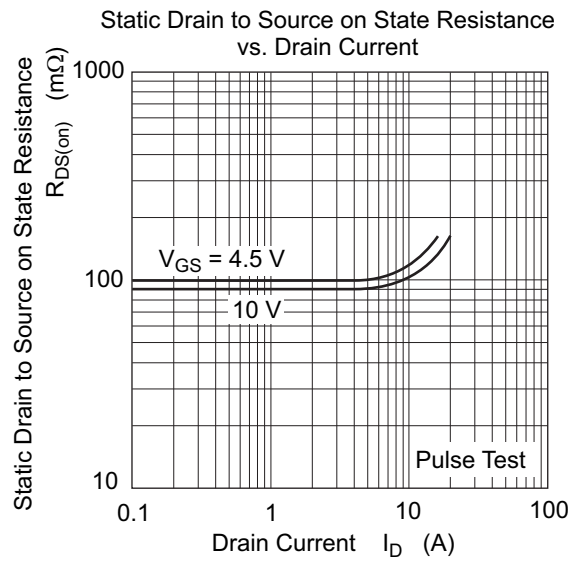
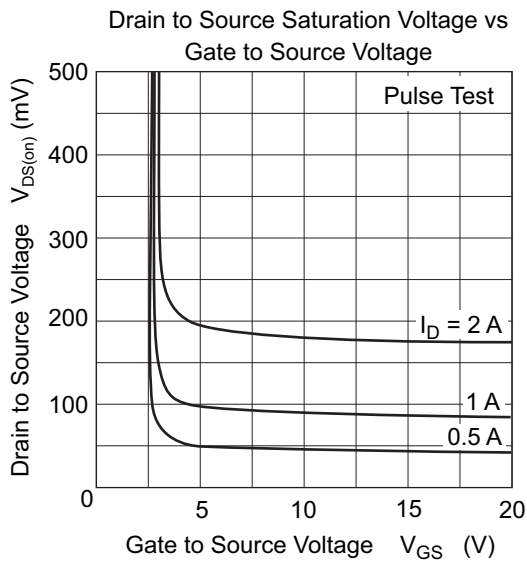
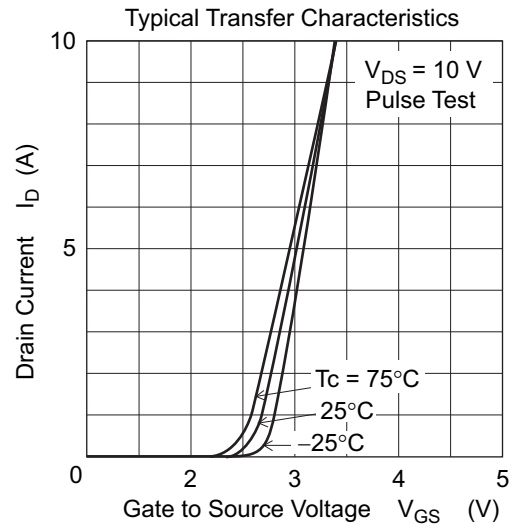
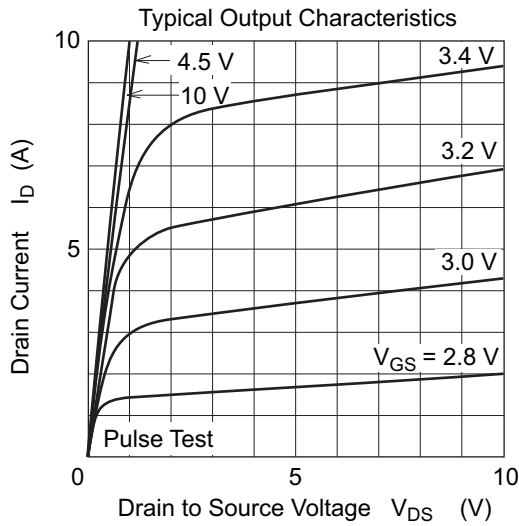

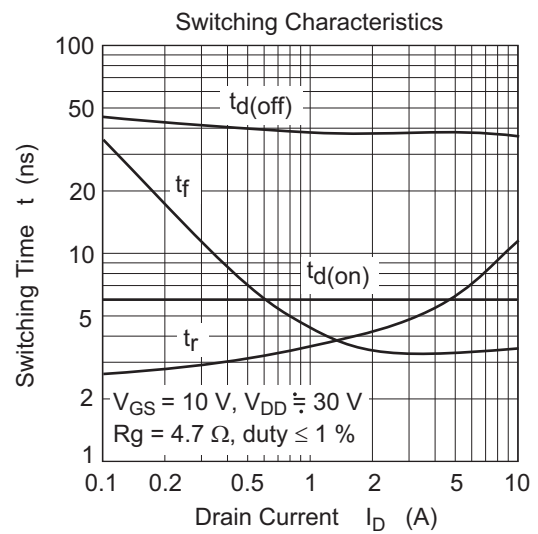
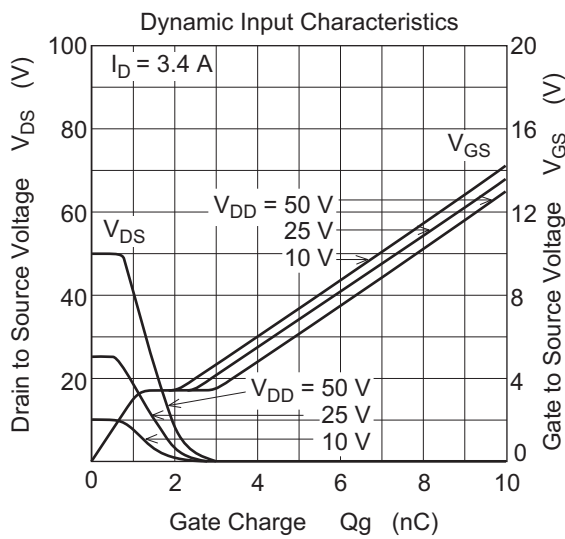
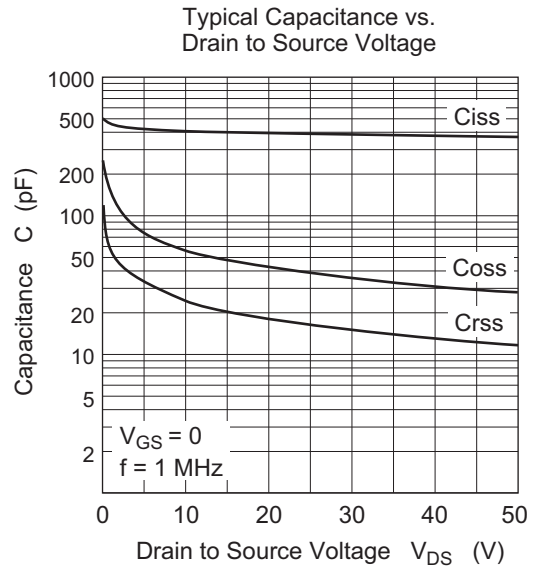
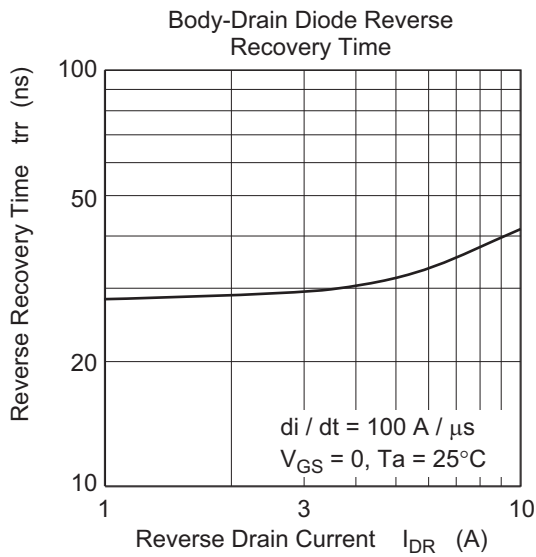
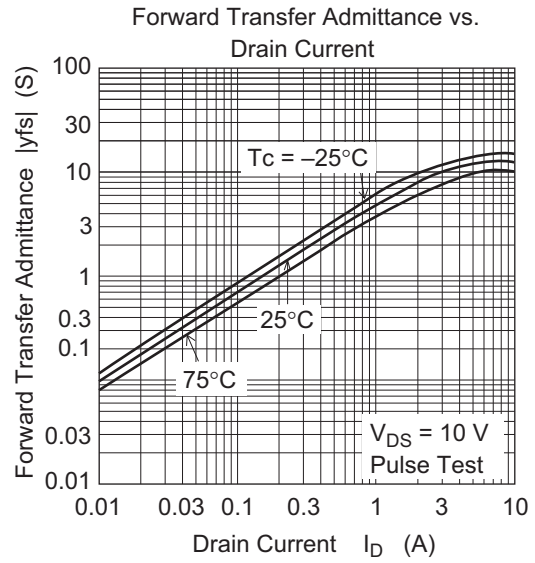
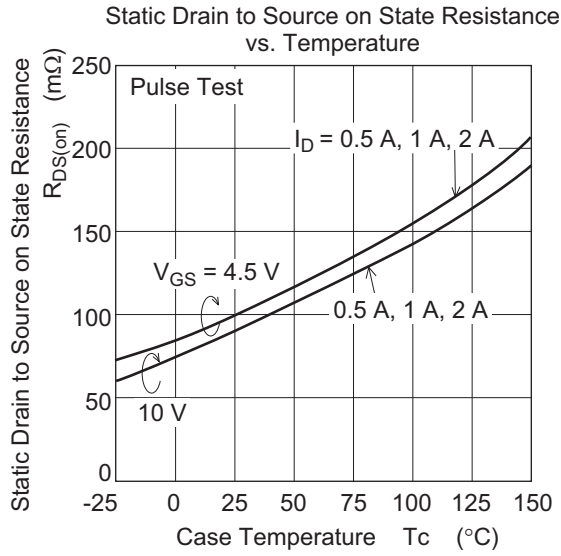

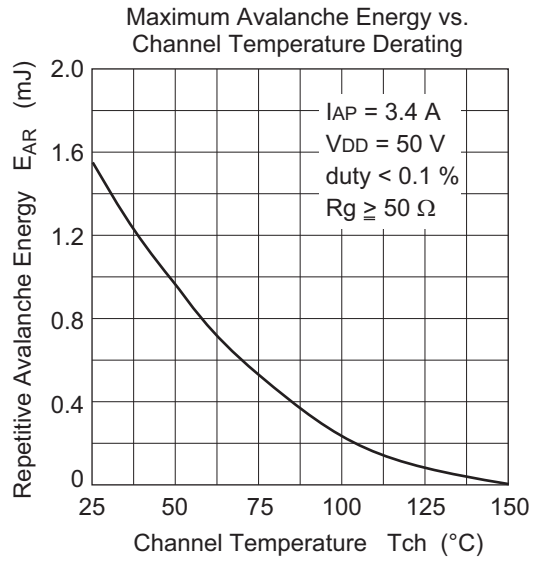
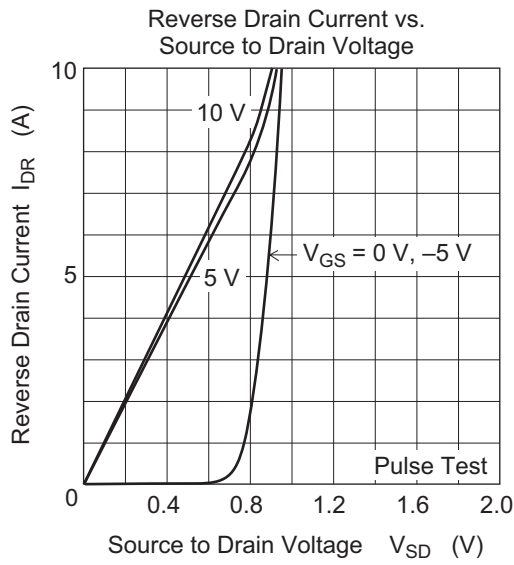

Switching Time Test Circuit

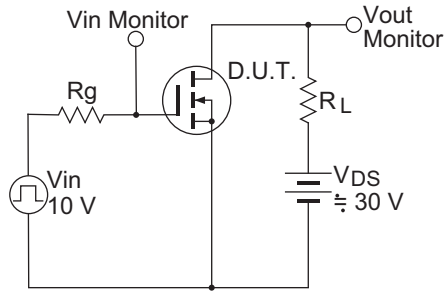

Switching Time Waveform

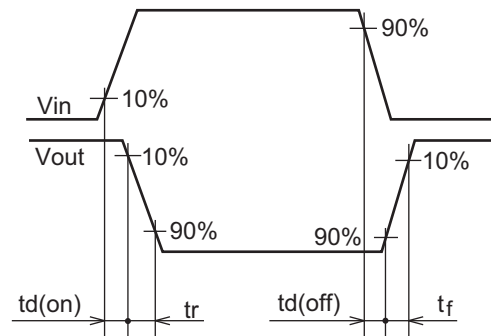

Avalanche Test Circuit

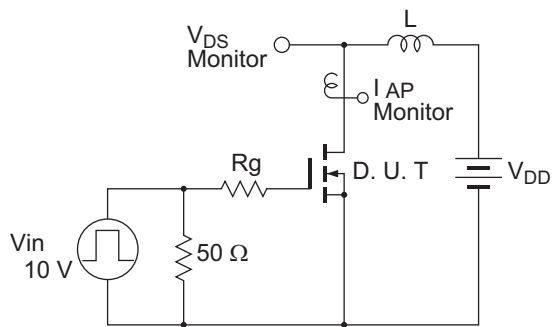

Avalanche Waveform

$$E_{AR} = \frac{1}{2} L \cdot I_{AP}^2 \cdot \frac{V_{DSS}}{V_{DSS} - V_{DD}}$$

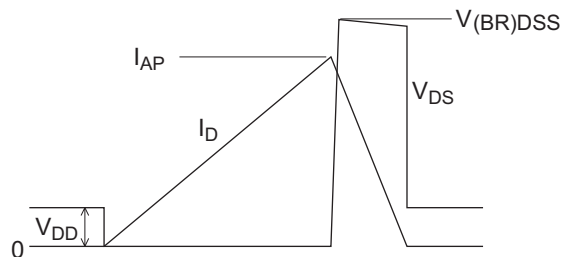

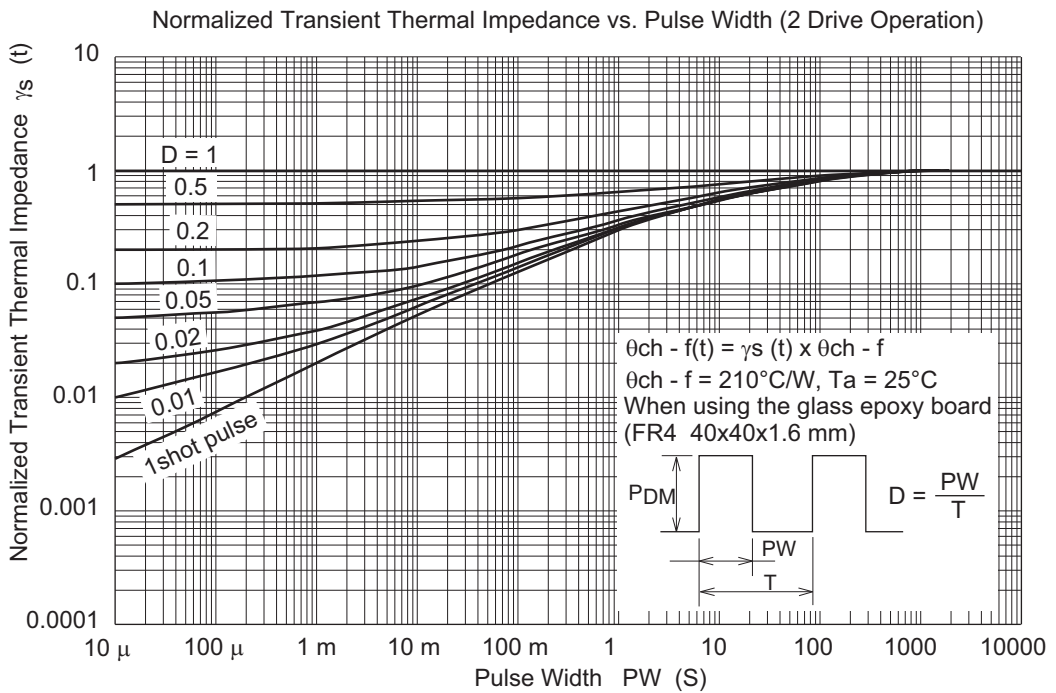
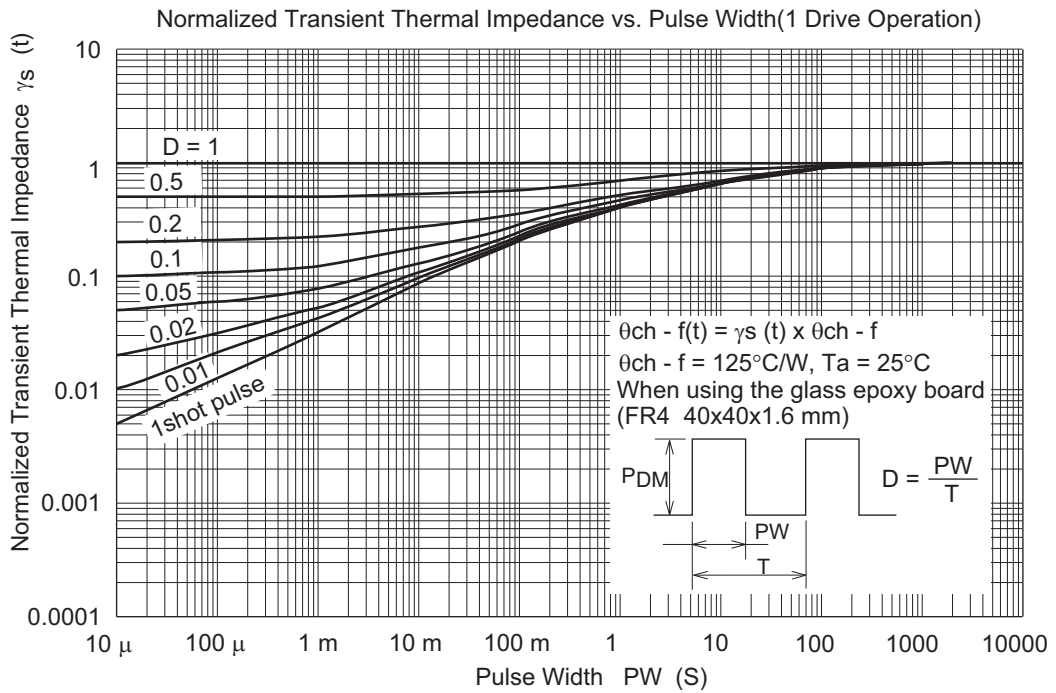

Package Dimensions

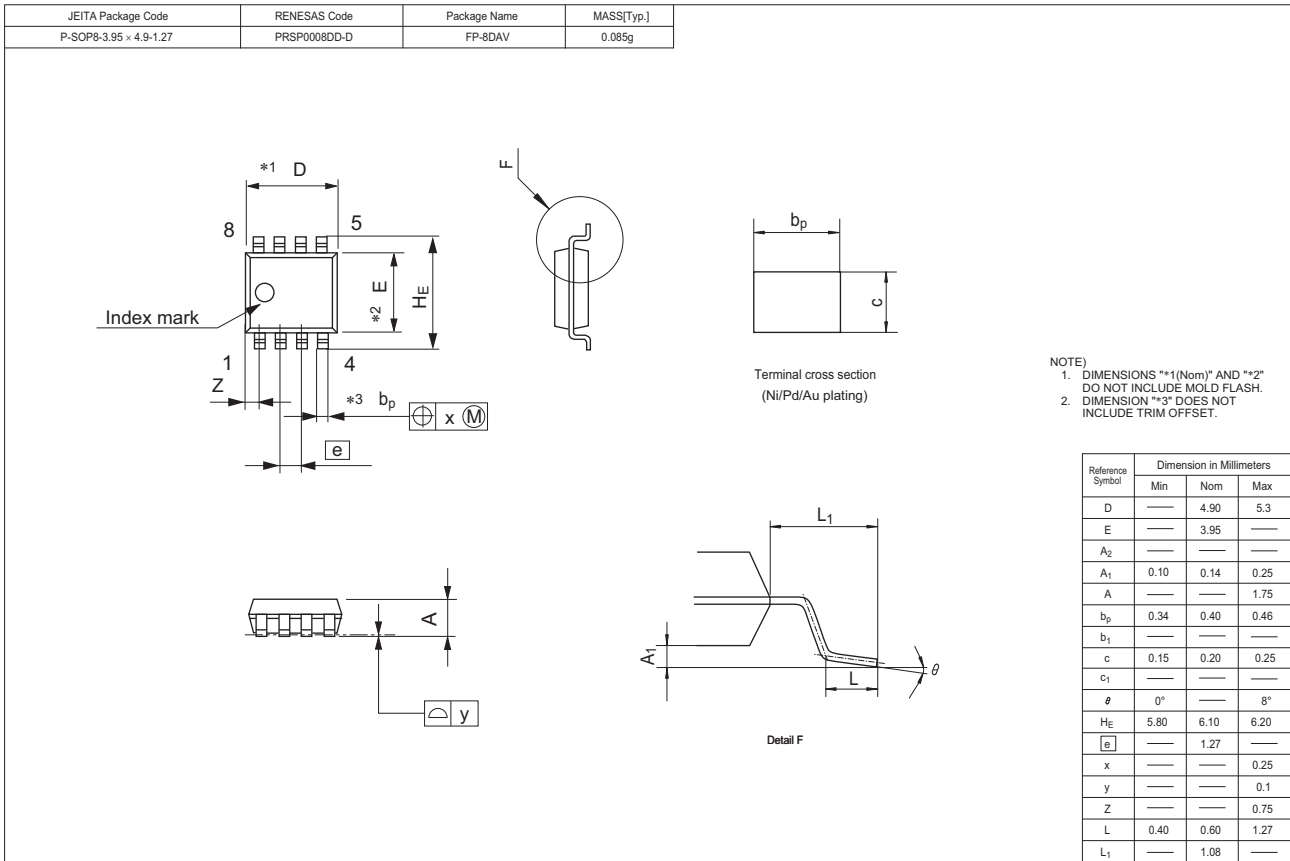

Ordering Information

Orderable Part Number	Quantity	Shipping Container
HAT2215R-EL-E	2500 pcs	Taping

Note: For some grades, production may be terminated. Please contact the Renesas sales Office to check the state of production before ordering the product.

## General Precautions in the Handling of Power MOSFET and IGBT Products

The following usage notes are applicable to general purpose Power MOSFET and IGBT products from Renesas. For detailed usage notes on the products covered by this document, refer to the relevant sections of the document as well as any technical updates that have been issued for the products.

### 1. Derating

Continuous heavy condition (e.g. high temperature/voltage/current or high variation of temperature) may affect a reliability even if it are within the absolute maximum ratings. Please consider derating condition for appropriate reliability in reference Renesas Semiconductor Reliability Handbook (Recommendation for Handling and Usage of Semiconductor Devices) and individual reliability data.

### 2. Quality grade

- The quality grade of this product is “Standard”.
- If you plan to use this product to “High quality” application, please inform to Renesas.
- Fail safe system is necessary to prevent malfunction even if this product is broken.



## Notice

1. Descriptions of circuits, software and other related information in this document are provided only to illustrate the operation of semiconductor products and application examples. You are fully responsible for the incorporation of these circuits, software, and information in the design of your equipment. Renesas Electronics assumes no responsibility for any losses incurred by you or third parties arising from the use of these circuits, software, or information.
2. Renesas Electronics has used reasonable care in preparing the information included in this document, but Renesas Electronics does not warrant that such information is error free. Renesas Electronics assumes no liability whatsoever for any damages incurred by you resulting from errors in or omissions from the information included herein.
3. Renesas Electronics does not assume any liability for infringement of patents, copyrights, or other intellectual property rights of third parties by or arising from the use of Renesas Electronics products or technical information described in this document. No license, express, implied or otherwise, is granted hereby under any patents, copyrights or other intellectual property rights of Renesas Electronics or others.
4. You should not alter, modify, copy, or otherwise misappropriate any Renesas Electronics product, whether in whole or in part. Renesas Electronics assumes no responsibility for any losses incurred by you or third parties arising from such alteration, modification, copy or otherwise misappropriation of Renesas Electronics product.
5. Renesas Electronics products are classified according to the following two quality grades: "Standard" and "High Quality". The recommended applications for each Renesas Electronics product depends on the product's quality grade, as indicated below.  
"Standard": Computers; office equipment; communications equipment; test and measurement equipment; audio and visual equipment; home electronic appliances; machine tools; personal electronic equipment; and industrial robots etc.  
"High Quality": Transportation equipment (automobiles, trains, ships, etc.); traffic control systems; anti-disaster systems; anti-crime systems; and safety equipment etc.  
Renesas Electronics products are neither intended nor authorized for use in products or systems that may pose a direct threat to human life or bodily injury (artificial life support devices or systems, surgical implantations etc.), or may cause serious property damages (nuclear reactor control systems, military equipment etc.). You must check the quality grade of each Renesas Electronics product before using it in a particular application. You may not use any Renesas Electronics product for any application for which it is not intended. Renesas Electronics shall not be in any way liable for any damages or losses incurred by you or third parties arising from the use of any Renesas Electronics product for which the product is not intended by Renesas Electronics.
6. You should use the Renesas Electronics products described in this document within the range specified by Renesas Electronics, especially with respect to the maximum rating, operating supply voltage range, movement power voltage range, heat radiation characteristics, installation and other product characteristics. Renesas Electronics shall have no liability for malfunctions or damages arising out of the use of Renesas Electronics products beyond such specified ranges.
7. Although Renesas Electronics endeavors to improve the quality and reliability of its products, semiconductor products have specific characteristics such as the occurrence of failure at a certain rate and malfunctions under certain use conditions. Further, Renesas Electronics products are not subject to radiation resistance design. Please be sure to implement safety measures to guard them against the possibility of physical injury, and injury or damage caused by fire in the event of the failure of a Renesas Electronics product, such as safety design for hardware and software including but not limited to redundancy, fire control and malfunction prevention, appropriate treatment for aging degradation or any other appropriate measures. Because the evaluation of microcomputer software alone is very difficult, please evaluate the safety of the final products or systems manufactured by you.
8. Please contact a Renesas Electronics sales office for details as to environmental matters such as the environmental compatibility of each Renesas Electronics product. Please use Renesas Electronics products in compliance with all applicable laws and regulations that regulate the inclusion or use of controlled substances, including without limitation, the EU RoHS Directive. Renesas Electronics assumes no liability for damages or losses occurring as a result of your noncompliance with applicable laws and regulations.
9. Renesas Electronics products and technology may not be used for or incorporated into any products or systems whose manufacture, use, or sale is prohibited under any applicable domestic or foreign laws or regulations. You should not use Renesas Electronics products or technology described in this document for any purpose relating to military applications or use by the military, including but not limited to the development of weapons of mass destruction. When exporting the Renesas Electronics products or technology described in this document, you should comply with the applicable export control laws and regulations and follow the procedures required by such laws and regulations.
10. It is the responsibility of the buyer or distributor of Renesas Electronics products, who distributes, disposes of, or otherwise places the product with a third party, to notify such third party in advance of the contents and conditions set forth in this document, Renesas Electronics assumes no responsibility for any losses incurred by you or third parties as a result of unauthorized use of Renesas Electronics products.
11. This document may not be reproduced or duplicated in any form, in whole or in part, without prior written consent of Renesas Electronics.
12. Please contact a Renesas Electronics sales office if you have any questions regarding the information contained in this document or Renesas Electronics products, or if you have any other inquiries.  
(Note 1) "Renesas Electronics" as used in this document means Renesas Electronics Corporation and also includes its majority-owned subsidiaries.  
(Note 2) "Renesas Electronics product(s)" means any product developed or manufactured by or for Renesas Electronics.

以下"注意事项"为从英语原稿翻译的中文译文, 仅作参考译文, 英文版的"Notice"具有正式效力。

## 注意事项

1. 本文件中记载的关于电路、软件和其他相关信息仅用于说明半导体产品的操作和应用实例。用户如在设备设计中应用本文件中的电路、软件和相关信息, 请自行负责。对于用户或第三方因使用上述电路、软件或信息而遭受的任何损失, 瑞萨电子不承担任何责任。
2. 在准备本文件所记载的信息的过程中, 瑞萨电子已尽量做到合理注意, 但是, 瑞萨电子并不保证这些信息都是准确无误的。用户因本文件中记载的信息的错误或遗漏而遭受的任何损失, 瑞萨电子不承担任何责任。
3. 对于因使用本文件中的瑞萨电子产品或技术信息而造成的侵权行为或因此而侵犯第三方的专利、版权或其他知识产权的行为, 瑞萨电子不承担任何责任。本文件所记载的内容不应视为对瑞萨电子或其他人所有的专利、版权或其他知识产权作出任何明示、默示或其它方式的许可及授权。
4. 用户不得更改、修改、复制或其他方式部分或全部地非法使用瑞萨电子的任何产品。对于用户或第三方因上述更改、修改、复制或以其他方式非法使用瑞萨电子产品的行为而遭受的任何损失, 瑞萨电子不承担任何责任。
5. 瑞萨电子产品根据其质量等级分为两个等级: "标准等级"和"高质量等级"。每种瑞萨电子产品推荐用途均取决于产品的质量等级, 如下所示:  
标准等级: 计算机、办公设备、通讯设备、测试和测量设备、视听设备、家用电器、机械工具、个人电子设备以及工业机器人等。  
高质量等级: 运输设备(汽车、火车、轮船等)、交通控制系统、防灾系统、预防犯罪系统以及安全设备等。  
瑞萨电子产品无意用于且未被授权用于可能对人类生命造成直接威胁的产品或系统以及可能造成人身伤害的产品或系统(人工生命维持装置或系统、植入体内的装置等)中, 或者可能造成重大财产损失的产品或系统(核反应堆控制系统、军用设备等)中。在将每种瑞萨电子产品用于某种特定应用之前, 用户应先确认其质量等级。不得将瑞萨电子产品用于超出其设计用途之外的任何应用。对于用户或第三方因将瑞萨电子产品用于其设计用途之外而遭受的任何损害或损失, 瑞萨电子不承担任何责任。
6. 使用本文件中记载的瑞萨电子产品时, 应在瑞萨电子指定的范围内, 特别是在最大额定值、电源工作电压范围、移动电源电压范围、热辐射特性、安装条件以及其他产品特性的范围内使用。对于在上述指定范围之外使用瑞萨电子产品而产生的故障或损失, 瑞萨电子不承担任何责任。
7. 虽然瑞萨电子一直致力于提高瑞萨电子产品的质量和可靠性, 但是, 半导体产品有其自身的具体特性, 如一定的故障发生率以及在某些使用条件下会发生故障等。此外, 瑞萨电子产品均未进行防辐射设计, 所以请采取安全保护措施, 以避免当瑞萨电子产品在发生故障而造成火灾时导致人身事故、伤害或损害的事故。例如进行软硬件安全设计(包括但不限于冗余设计、防火控制以及故障预防等)、适当的老化处理或其他适当的措施等。由于难于对微机电系统单独进行评估, 所以请用户自行对最终产品或系统进行安全评估。
8. 关于环境保护方面的详细内容, 例如每种瑞萨电子产品的环境兼容性等, 请与瑞萨电子的营业部门联系。使用瑞萨电子产品时, 请遵守对管制物质的使用或含量进行管理的所有相关法律法规(包括但不限于《欧盟RoHS指令》)。对于因用户未遵守相关法律法规而导致的损害或损失, 瑞萨电子不承担任何责任。
9. 不可将瑞萨电子产品和技术用于或者嵌入日本国内或海外相应的法律法规所禁止生产、使用及销售的任何产品或系统中。也不可对本文件中记载的瑞萨电子产品或技术用于与军事应用或者军事用途有关的目的(如大规模杀伤性武器的开发等)。在本文件中记载的瑞萨电子产品或技术进行出口时, 应当遵守相应的出口管制法律法规, 并按照上述法律法规所规定的程序进行。
10. 向第三方分销或处分产品或者以其他方式将产品置于第三方控制之下的瑞萨电子产品买方或分销商, 有责任事先向上述第三方通知本文件规定的内容和条件; 对于用户或第三方因非法使用瑞萨电子产品而遭受的任何损失, 瑞萨电子不承担任何责任。
11. 在事先未得到瑞萨电子书面认可的情况下, 不得以任何形式部分或全部转载或复制本文件。
12. 如果对本文件所记载的信息或瑞萨电子产品有任何疑问, 或者用户有任何其他疑问, 请向瑞萨电子的营业部门咨询。  
(注1) 瑞萨电子: 在本文件中指瑞萨电子株式会社及其控股子公司。  
(注2) 瑞萨电子产品: 指瑞萨电子开发或生产的任何产品。



## SALES OFFICES

## Renesas Electronics Corporation

<http://www.renesas.com>

Refer to "<http://www.renesas.com/>" for the latest and detailed information.

**Renesas Electronics America Inc.**  
2801 Scott Boulevard Santa Clara, CA 95050-2549, U.S.A.  
Tel: +1-408-588-6000, Fax: +1-408-588-6130

**Renesas Electronics Canada Limited**  
3251 Yonge Street, Suite 8309 Richmond Hill, Ontario Canada L4C 9T3  
Tel: +1-905-237-2004

**Renesas Electronics Europe Limited**  
Dukes Meadow, Millboard Road, Bourne End, Buckinghamshire, SL8 5FH, UK  
Tel: +44-1628-585-100, Fax: +44-1628-585-900

**Renesas Electronics Europe GmbH**  
Arcadiastrasse 10, 40472 Düsseldorf, Germany  
Tel: +49-211-6503-0, Fax: +49-211-6503-1327

**Renesas Electronics (China) Co., Ltd.**  
Room 1709, Quantum Plaza, No.27 ZhiChunLu Haidian District, Beijing 100191, P.R.China  
Tel: +86-10-8235-1155, Fax: +86-10-8235-7679

**Renesas Electronics (Shanghai) Co., Ltd.**  
Unit 301, Tower A, Central Towers, 555 Langao Road, Putuo District, Shanghai, P. R. China 200333  
Tel: +86-21-2226-0888, Fax: +86-21-2226-0899

**Renesas Electronics Hong Kong Limited**  
Unit 1601-1611, 16/F., Tower 2, Grand Century Place, 193 Prince Edward Road West, Mongkok, Kowloon, Hong Kong  
Tel: +852-2265-6988, Fax: +852-2886-9022

**Renesas Electronics Taiwan Co., Ltd.**  
13F, No. 363, Fu Shing North Road, Taipei 10543, Taiwan  
Tel: +886-2-8175-9600, Fax: +886-2-8175-9670

**Renesas Electronics Singapore Pte. Ltd.**  
80 Bendemeer Road, Unit #06-02 Hyflux Innovation Centre, Singapore 339949  
Tel: +65-6215-0200, Fax: +65-6215-0300

**Renesas Electronics Malaysia Sdn.Bhd.**  
Unit 1207, Block B, Menara Amcorp, Amcorp Trade Centre, No. 18, Jin Persiaran Barat, 46050 Petaling Jaya, Selangor Darul Ehsan, Malaysia  
Tel: +60-3-7855-9390, Fax: +60-3-7855-9510

**Renesas Electronics India Pvt. Ltd.**  
No. 777C, 100 Feet Road, HAL, Stage, Indiranagar, Bangalore, India  
Tel: +91-80-67208700, Fax: +91-80-67208777

**Renesas Electronics Korea Co., Ltd.**  
12F., 234 Teheran-ro, Gangnam-Gu, Seoul, 135-080, Korea  
Tel: +82-2-558-3737, Fax: +82-2-558-5141