

DSN17 SERIES SINGLE OUTPUT

DESCRIPTION

With power densities up to 25 watts per cubic inch (1.53 watts per cm³), the DSN17 Series delivers 3.5 amperes of current at either 5 or 3.3 volts. Designed for digital and microprocessor applications, the non-isolated flat package requires only 1 square inch (6.45 cm²) of PCB area. Remote ON/OFF gives additional system flexibility. The 100KHz operating frequency of the DSN17 Series allows an increased power density while including adequate heat sinking and input/output filtering. This eliminates the need for external components in some applications. The Series' input range and no load input current (5mA) makes it well suited for battery operation in commercial and industrial applications. Full overload protection is provided by pulse-by-pulse current limiting.

FEATURES

- Up to 17 Watts Output Power
- Single In Line Package
- Power Density up to 25 Watts per Cubic Inch
- Efficiencies to 88% (Lower for 3.3V Output)
- High Efficiency Step Down Regulator
- Remote ON/OFF

Selection Chart				
Model	Input Range VDC		Output VDC	Output mA
	Min	Max		
DSN17N5S3.3	4.5	6	3.3	3500
DSN17N12S5	6.5	15.5	5	3500

General Specifications (1)				
All Models				Units
ON/OFF Function				
OFF Logic Level or Leave Pin Open	MIN	> 2.0	VDC	
ON Logic Level or Tie Pin to -Input	MAX	< 0.5	VDC	
Maximum Voltage	MAX	V _{in} +0.3V	VDC	
Converter Idle Current ON/OFF Pin High	TYP	5	µA	
Environmental				
Case Operating Range, Tc No Derating	MIN	-40	°C	
	MAX	85	°C	
Case Functional Range (2)	MIN	-50	°C	
	MAX	95	°C	
Storage Range	MIN	-55	°C	
	MAX	105	°C	
Thermal Impedance (3)	TYP	20	°C/Watt	
General				
MTBF (Calculated)	TYP	800,000	HRS	
Unit Weight	TYP	1.0 / 28	oz / gm	

NOTES

- (1) All parameters measured at Tc = 25°C, nominal input voltage and full rated load unless otherwise noted. Refer to the Technical Reference Section for the definition of terms, measurement circuits and other information.
- (2) The functional temperature range is intended to give an additional data point for use in evaluating this power supply. At the low functional temperature the power supply will function with no side effects, however, sustained operation at the high functional temperature will reduce expected operational life. The data sheet specifications are not guaranteed beyond the case operating range.
- (3) The case thermal impedance is specified as the case temperature rise over ambient per package watt dissipated.

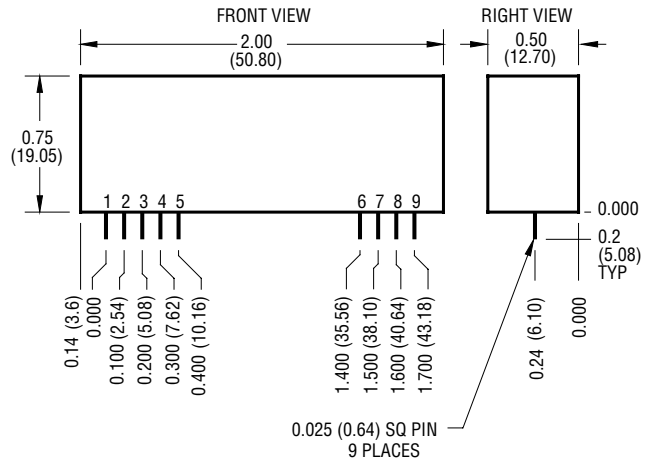

Mechanical tolerances unless otherwise noted:

X.XX dimensions: ±0.020 inches

X.XXX dimensions: ±0.005 inches

Pin	Function	Pin	Function
1	ON/OFF	6	-OUTPUT
2	+INPUT	7	-OUTPUT
3	+INPUT	8	+OUTPUT
4	-INPUT	9	+OUTPUT
5	-INPUT		

DSN17 SERIES – SINGLE OUTPUT

Input Parameters (1)				
Model		DSN17N5S3.3	DSN17N12S5	Units
Voltage Range	MIN	4.5	6.5	VDC
	MAX	6.0	15.5	
Input Current	Full Load	2615	1635	mA
	No Load	1	1	
Efficiency	TYP	86	88	%
Switching Frequency	TYP	100		kHz
Maximum Input Overvoltage, 200ms Maximum	MAX	7.5	17.0	VDC
Turn-on Time, 1% Output Error	TYP	200	10	ms

Output Parameters (1)				
Model		DSN17N5S3.3	DSN17N12S5	Units
Output Voltage		3.30	5.00	VDC
Output Voltage Accuracy (3) Worst Case	MIN	3.20	4.80	VDC
	TYP	3.30	5.00	
	MAX	3.39	5.25	
Rated Load Range	MIN	0		mA
	MAX	3500		
Load Regulation 25% Max Load - Max Load (5)	TYP	1.7		%
	MAX	2.5		
Line Regulation Vin = Min-Max VDC	TYP	0.2	0.4	%
	MAX	1.0	1.0	
Short Term Stability (4)	TYP	< 0.01		%/24Hrs
Noise, Peak - Peak (2) (5)	TYP	40	60	mV _{PP}
RMS Noise	TYP	5	8	mV _{rms}
Temperature Coefficient	TYP	50		ppm/°C
	MAX	150		
Short Circuit Protection to Common		Continuous Current Limit		

NOTES

- (1) All parameters measured at Tc = 25°C, nominal input voltage and full rated load unless otherwise noted. Refer to the Technical Reference Section for the definition of terms, measurement circuits and other information.
- (2) Noise is measured per Technical Reference Section. Measurement bandwidth is 0-20 MHz. RMS noise is measured over a 0.01-1 MHz bandwidth. To simulate standard PCB decoupling practices, output noise is measured with a 1µF tantalum and 0.01µF ceramic capacitor located 1 inch away from the converter.
- (3) The worst case output voltage includes line, load and temperature effects.
- (4) Short term stability is defined as the drift over 24 hours with constant line, load and ambient temperature conditions.
- (5) Requires a 470µF/16V capacitor across output terminals.

DSN17 SERIES APPLICATION NOTES:

External Capacitance Requirements

No external input capacitance is required for operation of the DSN17 Series. To meet the reflected ripple requirements of the converter, an input impedance of less than 0.075 Ω from DC to 100KHz is required. If a capacitive input source is farther than 2" from the converter, an additional capacitor may be required at the input pins for proper operation. External output capacitance is not

required for operation above 50% output power, however it is recommended that 1µF to 10µF of tantalum and 0.001 to 0.1µF ceramic capacitance be selected for reduced system noise. Operation below 50% output power may require the addition of a 470µF capacitor to meet noise specifications.

Negative Outputs

Due to the non-isolated nature of the DSN17 Series, generation of negative output voltages is not possible.

Remote ON/OFF Operation

The remote ON/OFF pin should be tied to the -INPUT pin if this function is not used. It is recommended to drive this pin with a CMOS or TTL gate. An open collector output may be used with a 2.2KΩ to 50KΩ resistor tied to +INPUT. When the ON/OFF pin is pulled low with respect to the -INPUT, the converter is placed in a low power drain state. The input capacitors are kept fully charged in the OFF mode. The OFF state current is typically less than 5mA.

DSN17 SERIES — SINGLE OUTPUT

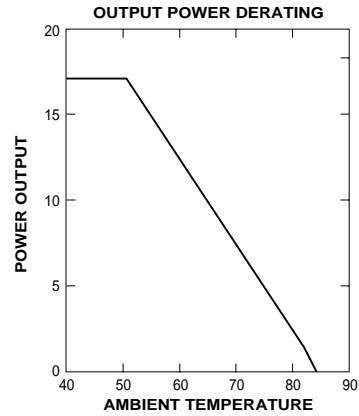
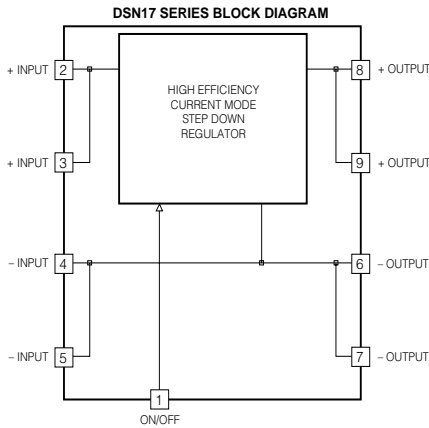

Typical Performance: (Tc=25°C, Vin=Nom VDC, Rated Load)

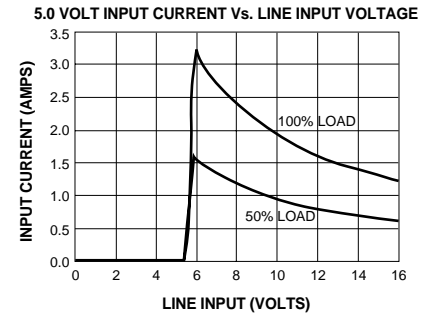
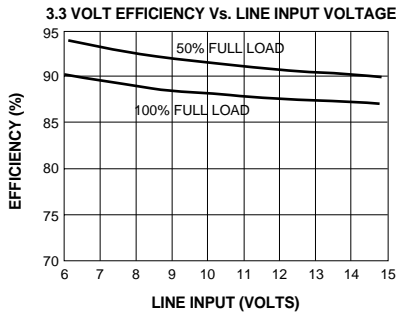
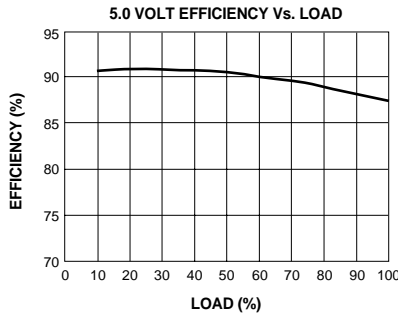
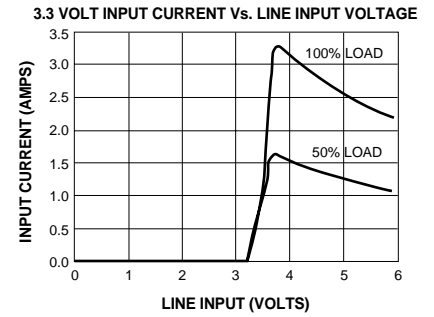
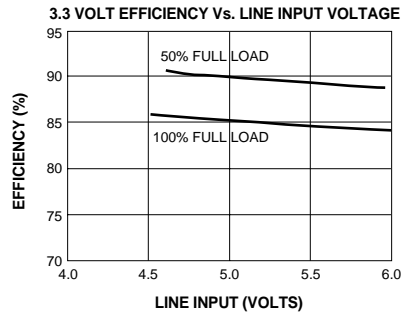
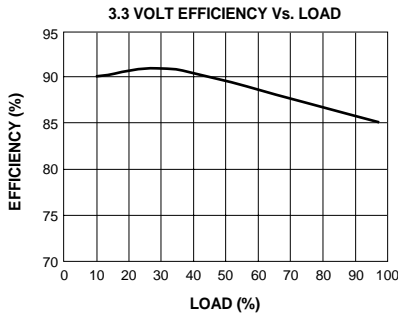

For the Most Up-To-Date Information

www.power-one.com

24 Hours/Day—7 Days/Week



NUCLEAR AND MEDICAL APPLICATIONS Power-One products are not authorized for use as critical components in life support systems, equipment used in hazardous environments, or nuclear control systems without the express written consent of the President of Power-One, Inc.

TECHNICAL REVISIONS The appearance of products, including safety agency certifications pictured on labels, may change depending on the date manufactured. Specifications are subject to change without notice.