

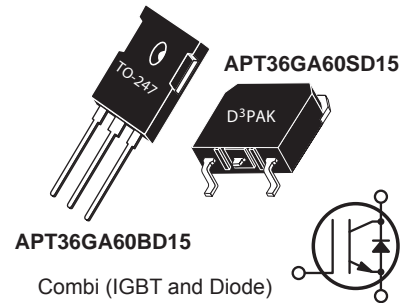

## High Speed PT IGBT

POWER MOS 8® is a high speed Punch-Through switch-mode IGBT. Low  $E_{off}$  is achieved through leading technology silicon design and lifetime control processes. A reduced  $E_{off} - V_{CE(ON)}$  tradeoff results in superior efficiency compared to other IGBT technologies. Low gate charge and a greatly reduced ratio of  $C_{res}/C_{ies}$  provide excellent noise immunity, short delay times and simple gate drive. The intrinsic chip gate resistance and capacitance of the poly-silicone gate structure help control di/dt during switching, resulting in low EMI, even when switching at high frequency.



### FEATURES

- Fast switching with low EMI
- Very Low  $E_{off}$  for maximum efficiency
- Ultra low  $C_{res}$  for improved noise immunity
- Low conduction loss
- Low gate charge
- Increased intrinsic gate resistance for low EMI
- RoHS compliant 

### TYPICAL APPLICATIONS

- ZVS phase shifted and other full bridge
- Half bridge
- High power PFC boost
- Welding
- UPS, solar, and other inverters
- High frequency, high efficiency industrial

### Absolute Maximum Ratings

Symbol	Parameter	Ratings	Unit
$V_{CES}$	Collector Emitter Voltage	600	V
$I_{C1}$	Continuous Collector Current @ $T_C = 25^\circ\text{C}$	65	A
$I_{C2}$	Continuous Collector Current @ $T_C = 100^\circ\text{C}$	36	
$I_{CM}$	Pulsed Collector Current <sup>1</sup>	109	
$V_{GE}$	Gate-Emitter Voltage <sup>2</sup>	$\pm 30$	V
$P_D$	Total Power Dissipation @ $T_C = 25^\circ\text{C}$	290	W
SSOA	Switching Safe Operating Area @ $T_J = 150^\circ\text{C}$	109A @ 600V	
$T_J, T_{STG}$	Operating and Storage Junction Temperature Range	-55 to 150	°C
$T_L$	Lead Temperature for Soldering: 0.063" from Case for 10 Seconds	300	

### Static Characteristics

$T_J = 25^\circ\text{C}$  unless otherwise specified

Symbol	Parameter	Test Conditions	Min	Typ	Max	Unit
$V_{BR(CES)}$	Collector-Emitter Breakdown Voltage	$V_{GE} = 0V, I_C = 1.0mA$	600			V
$V_{CE(on)}$	Collector-Emitter On Voltage	$V_{GE} = 15V, I_C = 20A$ $T_J = 25^\circ\text{C}$ $T_J = 125^\circ\text{C}$		2.0 1.9	2.5	
$V_{GE(th)}$	Gate Emitter Threshold Voltage	$V_{GE} = V_{CE}, I_C = 1mA$	3	4.5	6	
$I_{CES}$	Zero Gate Voltage Collector Current	$V_{CE} = 600V, V_{GE} = 0V$ $T_J = 25^\circ\text{C}$ $T_J = 125^\circ\text{C}$			275 3000	$\mu\text{A}$
$I_{GES}$	Gate-Emitter Leakage Current	$V_{GS} = \pm 30V$			$\pm 100$	nA

## Dynamic Characteristics

$T_J = 25^\circ\text{C}$  unless otherwise specified

APT36GA60B\_SD15

Symbol	Parameter	Test Conditions	Min	Typ	Max	Unit	
$C_{ies}$	Input Capacitance	Capacitance $V_{GE} = 0V, V_{CE} = 25V$ $f = 1\text{MHz}$		2880		pF	
$C_{oes}$	Output Capacitance			226			
$C_{res}$	Reverse Transfer Capacitance			328			
$Q_g$	Total Gate Charge <sup>3</sup>	Gate Charge $V_{GE} = 15V$ $V_{CE} = 300V$ $I_C = 20A$		102		nC	
$Q_{ge}$	Gate-Emitter Charge			18			
$Q_{gc}$	Gate-Collector Charge			36			
SSOA	Switching Safe Operating Area	$T_J = 150^\circ\text{C}, R_G = 10\Omega^4, V_{GE} = 15V,$ $L = 100\mu\text{H}, V_{CE} = 600V$	109			A	
$t_{d(on)}$	Turn-On Delay Time	Inductive Switching ( $25^\circ\text{C}$ ) $V_{CC} = 400V$ $V_{GE} = 15V$ $I_C = 20A$ $R_G = 10\Omega^4$ $T_J = +25^\circ\text{C}$		16		ns	
$t_r$	Current Rise Time			14			
$t_{d(off)}$	Turn-Off Delay Time			122			
$t_f$	Current Fall Time			77			
$E_{on2}$	Turn-On Switching Energy	Inductive Switching ( $125^\circ\text{C}$ ) $V_{CC} = 400V$ $V_{GE} = 15V$ $I_C = 20A$ $R_G = 10\Omega^4$ $T_J = +125^\circ\text{C}$		307		$\mu\text{J}$	
$E_{off}$	Turn-Off Switching Energy <sup>6</sup>			254			
$t_{d(on)}$	Turn-On Delay Time			14			ns
$t_r$	Current Rise Time			15			
$t_{d(off)}$	Turn-Off Delay Time		149				
$t_f$	Current Fall Time		113				
$E_{on2}$	Turn-On Switching Energy			508		$\mu\text{J}$	
$E_{off}$	Turn-Off Switching Energy <sup>6</sup>			439			

## Thermal and Mechanical Characteristics

Symbol	Characteristic	Min	Typ	Max	Unit
$R_{\theta JC}$	Junction to Case Thermal Resistance (IGBT)	-	-	.43	$^\circ\text{C/W}$
$R_{\theta JC}$	Junction to Case Thermal Resistance (Diode)			1.35	
$W_T$	Package Weight	-	5.9	-	g
Torque	Mounting Torque (TO-247 Package), 4-40 or M3 screw			10	in-lbf

1 Repetitive Rating: Pulse width and case temperature limited by maximum junction temperature.

2 Pulse test: Pulse Width <  $380\mu\text{s}$ , duty cycle < 2%.

3 See Mil-Std-750 Method 3471.

4  $R_G$  is external gate resistance, not including internal gate resistance or gate driver impedance. (MIC4452)

5  $E_{on2}$  is the clamped inductive turn on energy that includes a commutating diode reverse recovery current in the IGBT turn on energy loss. A combi device is used for the clamping diode.

6  $E_{off}$  is the clamped inductive turn-off energy measured in accordance with JEDEC standard JESD24-1.

Microsemi reserves the right to change, without notice, the specifications and information contained herein.

# Typical Performance Curves

APT36GA60BD\_S15

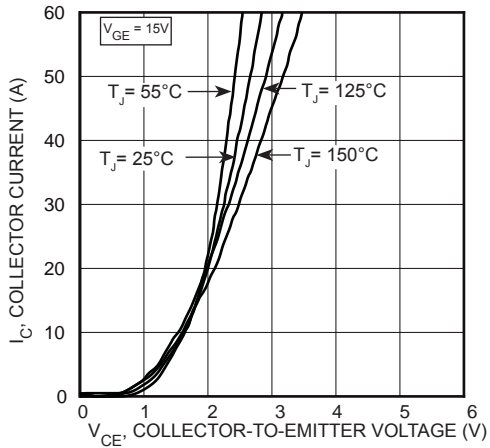

FIGURE 1, Output Characteristics ( $T_J = 25^\circ\text{C}$ )

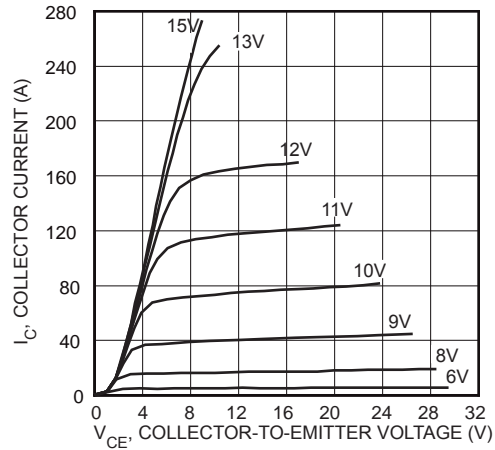

FIGURE 2, Output Characteristics ( $T_J = 25^\circ\text{C}$ )

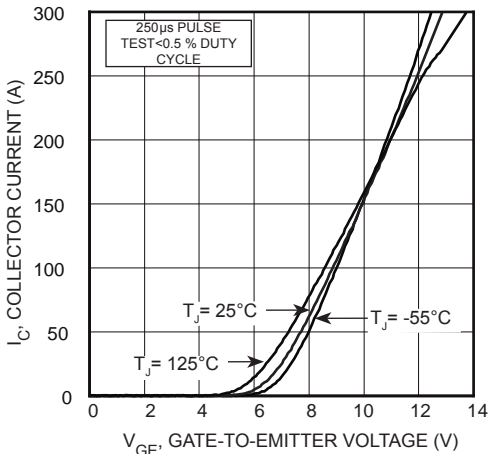

FIGURE 3, Transfer Characteristics

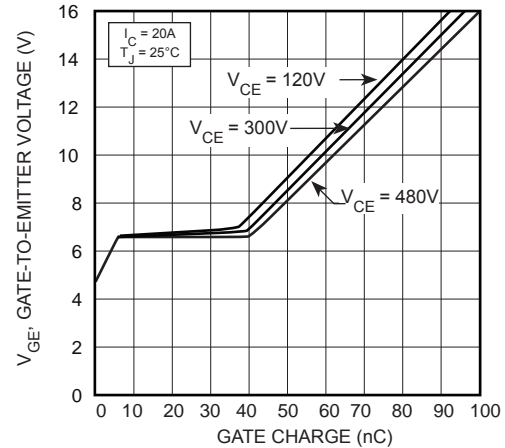

FIGURE 4, Gate charge

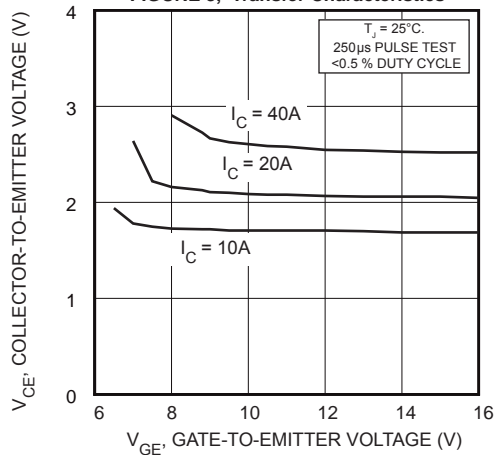

FIGURE 5, On State Voltage vs Gate-to-Emitter Voltage

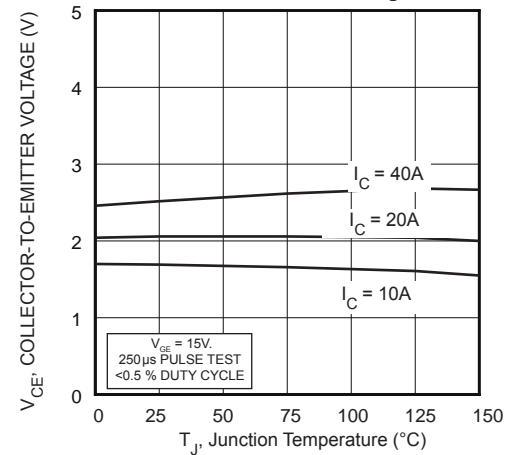

FIGURE 6, On State Voltage vs Junction Temperature

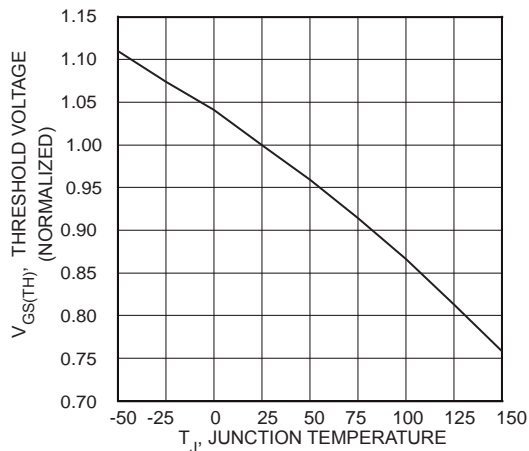

FIGURE 7, Threshold Voltage vs Junction Temperature

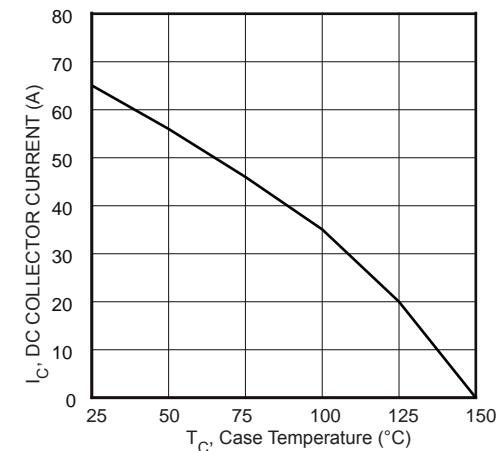

FIGURE 8, DC Collector Current vs Case Temperature

# Typical Performance Curves

APT36GA60BD\_S15

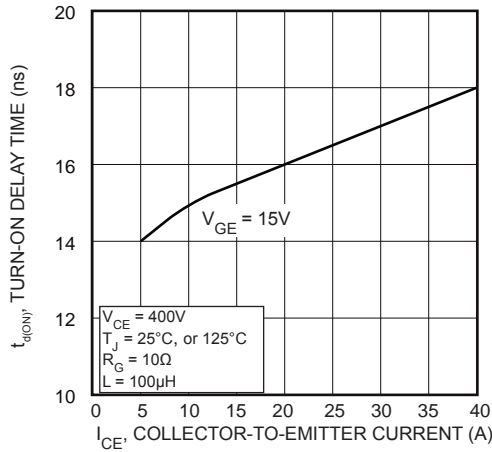

FIGURE 9, Turn-On Delay Time vs Collector Current

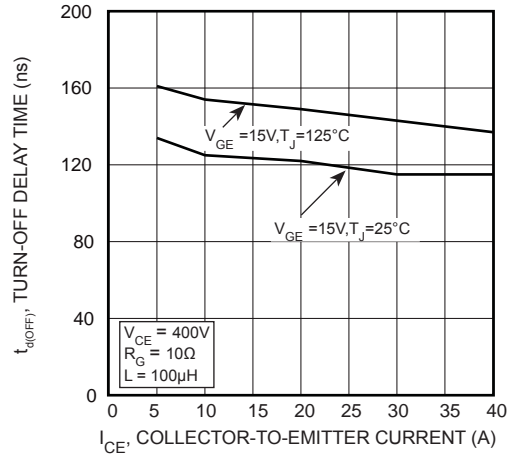

FIGURE 10, Turn-Off Delay Time vs Collector Current

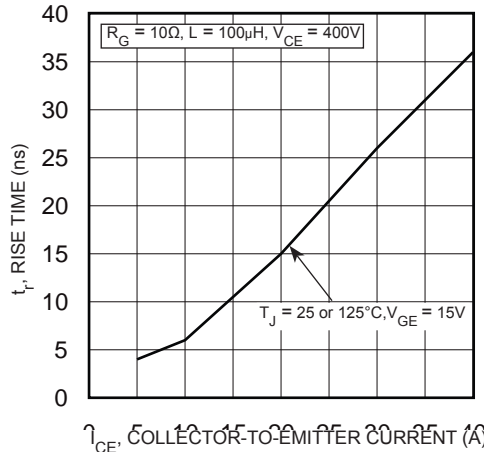

FIGURE 11, Current Rise Time vs Collector Current

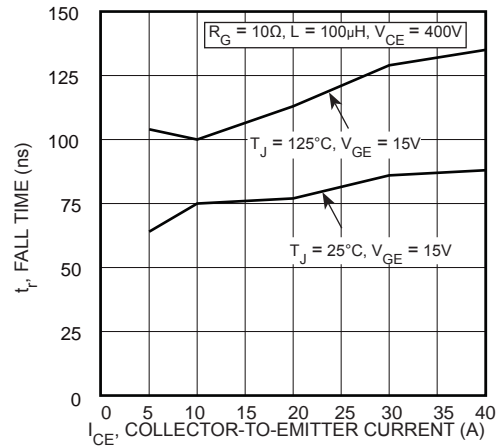

FIGURE 12, Current Fall Time vs Collector Current

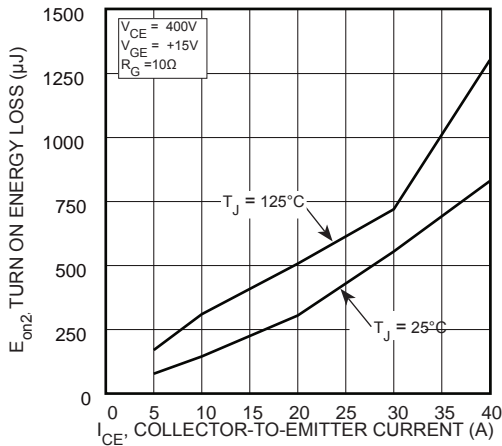

FIGURE 13, Turn-On Energy Loss vs Collector Current

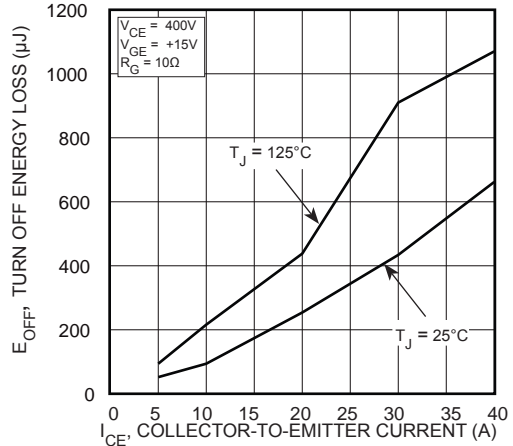

FIGURE 14, Turn-Off Energy Loss vs Collector Current

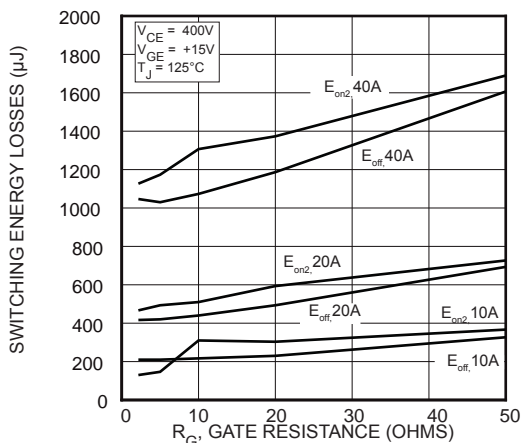

FIGURE 15, Switching Energy Losses vs Gate Resistance

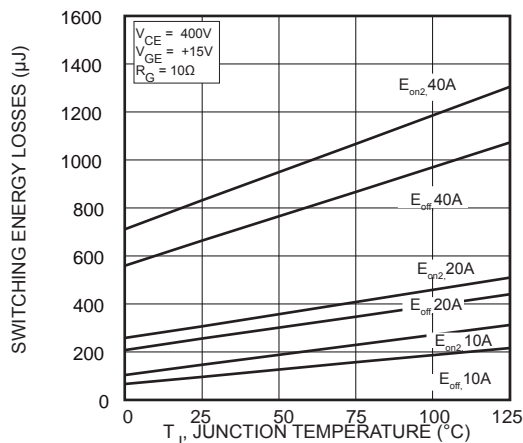

FIGURE 16, Switching Energy Losses vs Junction Temperature

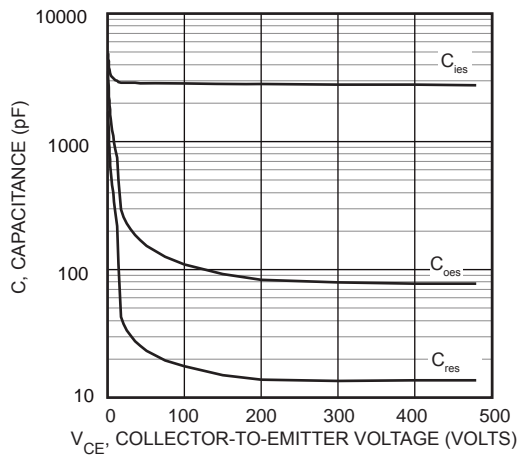

FIGURE 17, Capacitance vs Collector-To-Emitter Voltage

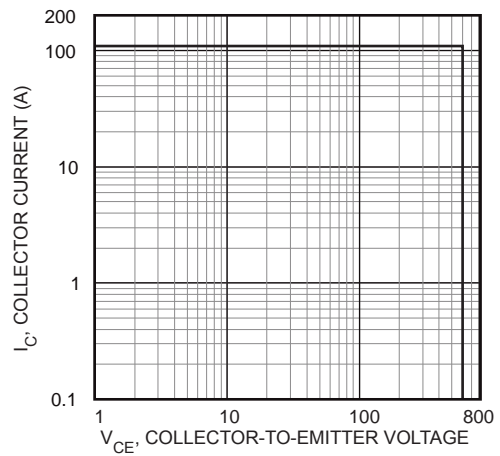

FIGURE 18, Minimum Switching Safe Operating Area

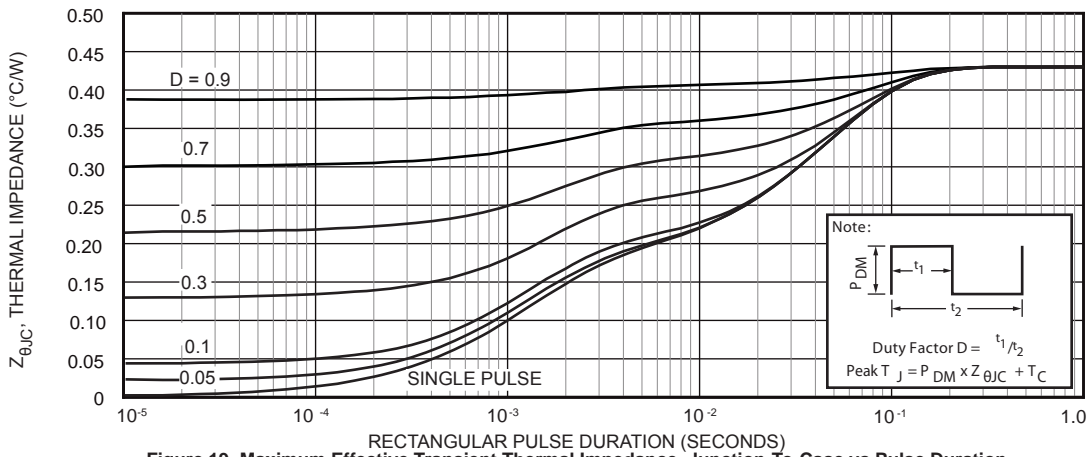

Figure 19, Maximum Effective Transient Thermal Impedance, Junction-To-Case vs Pulse Duration

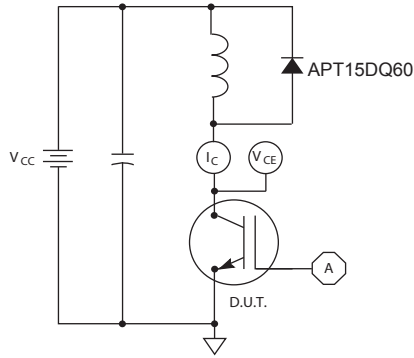

Figure 20, Inductive Switching Test Circuit

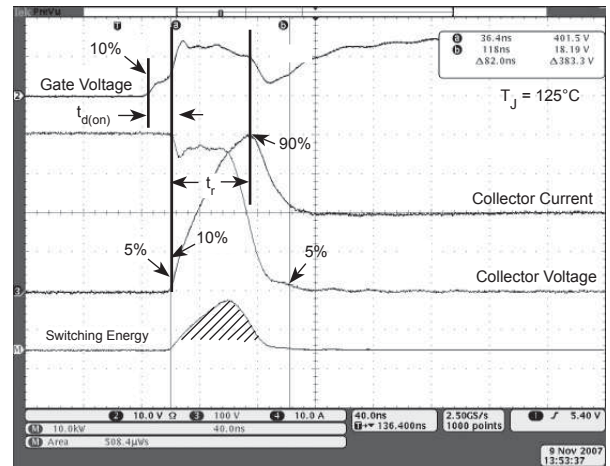

Figure 21, Turn-on Switching Waveforms and Definitions

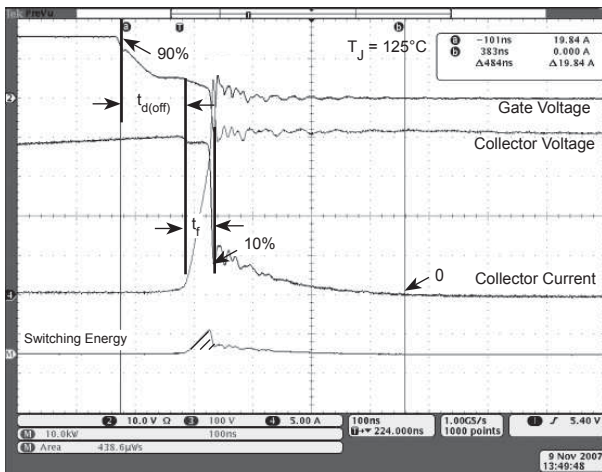

Figure 22, Turn-off Switching Waveforms and Definitions

# ULTRAFAST SOFT RECOVERY RECTIFIER DIODE

## MAXIMUM RATINGS

All Ratings:  $T_C = 25^\circ\text{C}$  unless otherwise specified.

Symbol	Characteristic / Test Conditions	APT36GA60B_SD15	Unit
$I_{F(AV)}$	Maximum Average Forward Current ( $T_C = 129^\circ\text{C}$ , Duty Cycle = 0.5)	15	Amps
$I_{F(RMS)}$	RMS Forward Current (Square wave, 50% duty)	30	
$I_{FSM}$	Non-Repetitive Forward Surge Current ( $T_J = 45^\circ\text{C}$ , 8.3 ms)	110	

## STATIC ELECTRICAL CHARACTERISTICS

Symbol	Characteristic / Test Conditions	Min	Type	Max	Unit
$V_F$	Forward Voltage		$I_F = 15\text{A}$	2.0	Volts
			$I_F = 30\text{A}$	2.5	
			$I_F = 15\text{A}, T_J = 125^\circ\text{C}$	1.56	

## DYNAMIC CHARACTERISTICS

Symbol	Characteristic	Test Conditions	Min	Typ	Max	Unit
$t_{rr}$	Reverse Recovery Time	$I_F = 1\text{A}, di_F/dt = -100\text{A}/\mu\text{s}, V_R = 30\text{V}, T_J = 25^\circ\text{C}$	-	15	-	ns
$t_{rr}$	Reverse Recovery Time	$I_F = 15\text{A}, di_F/dt = -200\text{A}/\mu\text{s}, V_R = 400\text{V}, T_C = 25^\circ\text{C}$	-	19	-	nAmps
$Q_{rr}$	Reverse Recovery Charge		-	21	-	
$I_{RRM}$	Maximum Reverse Recovery Current		-	2	-	
$t_{rr}$	Reverse Recovery Time	$I_F = 15\text{A}, di_F/dt = -200\text{A}/\mu\text{s}, V_R = 400\text{V}, T_C = 125^\circ\text{C}$	-	105	-	ns
$Q_{rr}$	Reverse Recovery Charge		-	250	-	nC
$I_{RRM}$	Maximum Reverse Recovery Current		-	5	-	Amps
$t_{rr}$	Reverse Recovery Time	$I_F = 15\text{A}, di_F/dt = -1000\text{A}/\mu\text{s}, V_R = 400\text{V}, T_C = 125^\circ\text{C}$	-	55	-	ns
$Q_{rr}$	Reverse Recovery Charge		-	420	-	nC
$I_{RRM}$	Maximum Reverse Recovery Current		-	15	-	Amps

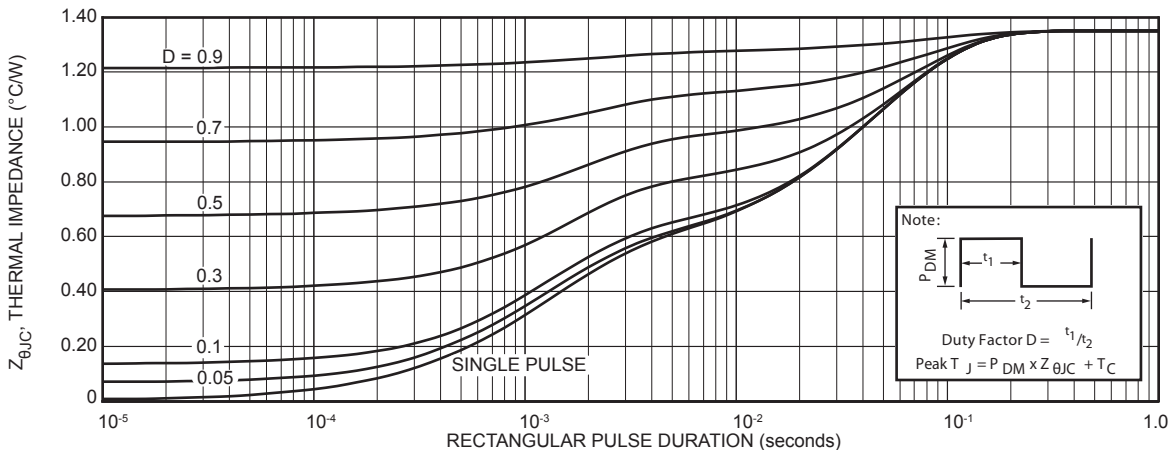

FIGURE 23. MAXIMUM EFFECTIVE TRANSIENT THERMAL IMPEDANCE, JUNCTION-TO-CASE vs. PULSE DURATION

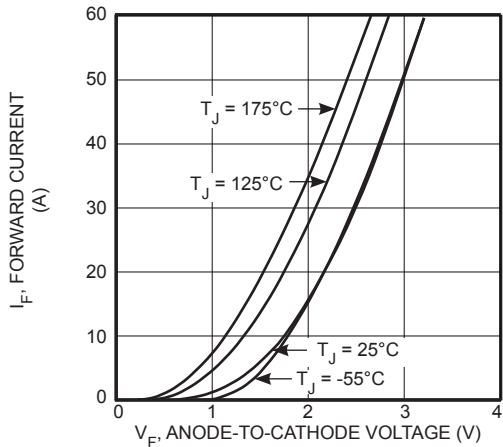

Figure 24. Forward Current vs. Forward Voltage

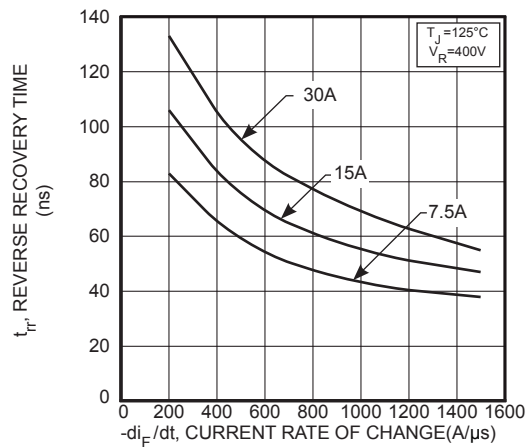

Figure 25. Reverse Recovery Time vs. Current Rate of Change

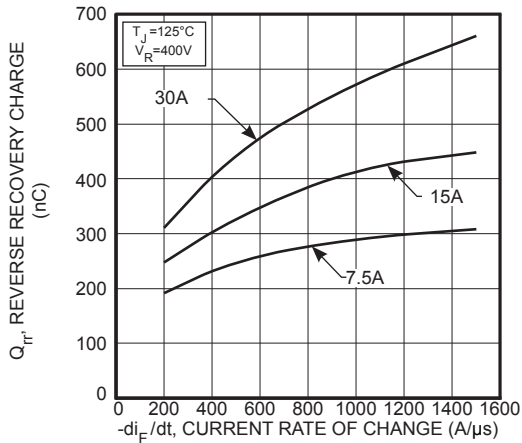

Figure 26. Reverse Recovery Charge vs. Current Rate of Change

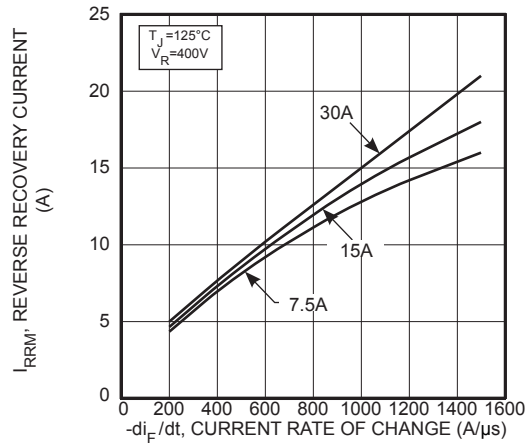

Figure 27. Reverse Recovery Current vs. Current Rate of Change

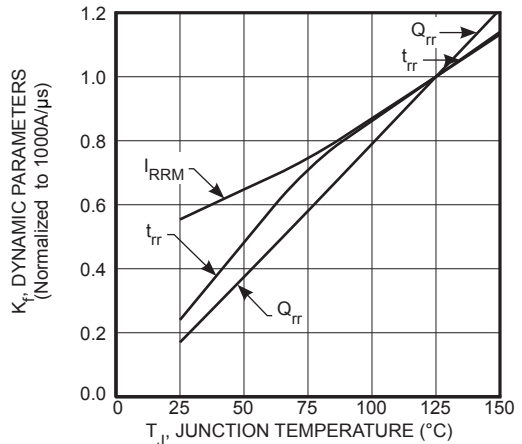

Figure 28. Dynamic Parameters vs. Junction Temperature

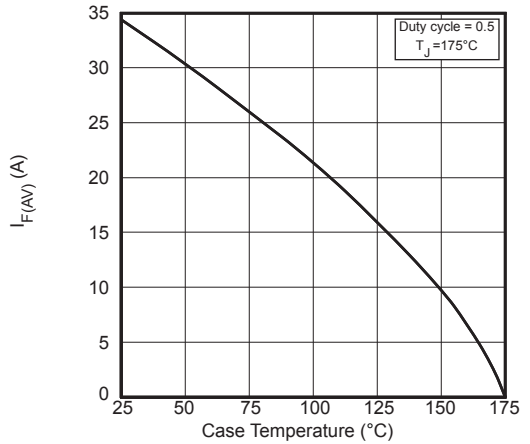

Figure 29. Maximum Average Forward Current vs. Case Temperature

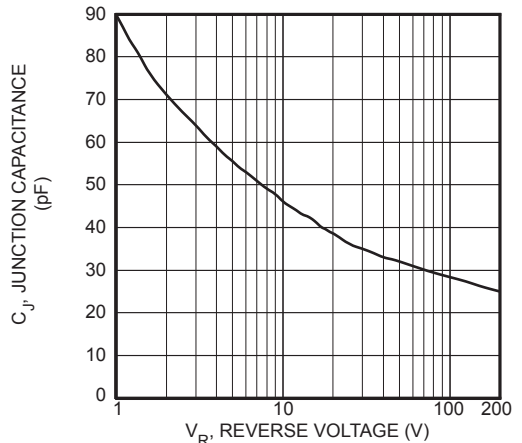

Figure 30. Junction Capacitance vs. Reverse Voltage



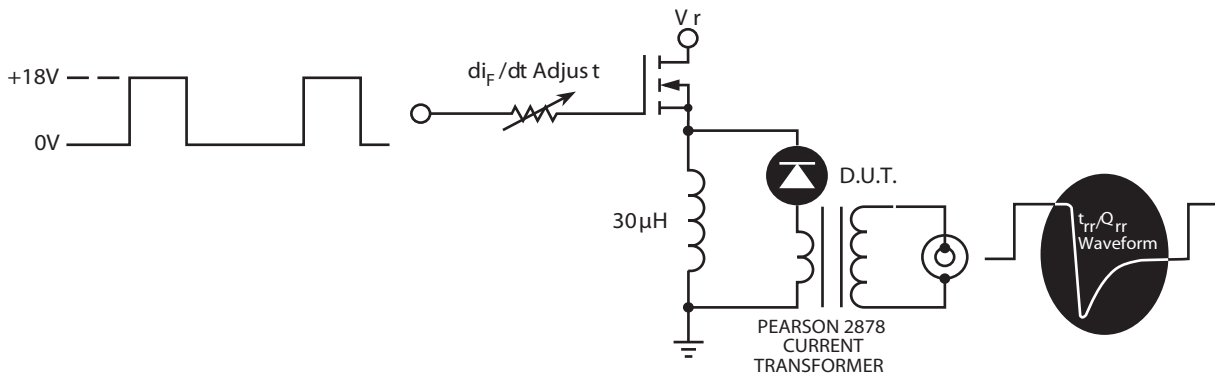

Figure 31. Diode Test Circuit

- 1 I<sub>F</sub> - Forward Conduction Current
- 2 di<sub>F</sub>/dt - Rate of Diode Current Change Through Zero Crossing.
- 3 I<sub>RRM</sub> - Maximum Reverse Recovery Current
- 4 t<sub>rr</sub> - Reverse Recovery Time measured from zero crossing where diode current goes from positive to negative, to the point at which the straight line through I<sub>RRM</sub> and 0.25 I<sub>RRM</sub> passes through zero.
- 5 Q<sub>rr</sub> - Area Under the Curve Defined by I<sub>RRM</sub> and t<sub>RR</sub>.

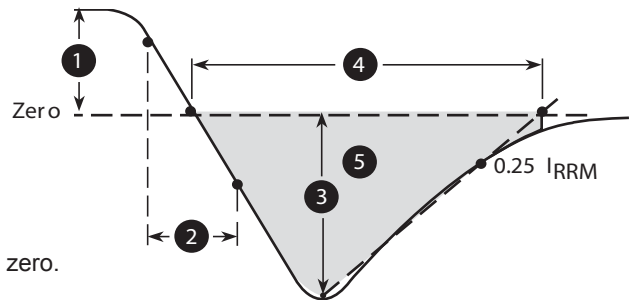
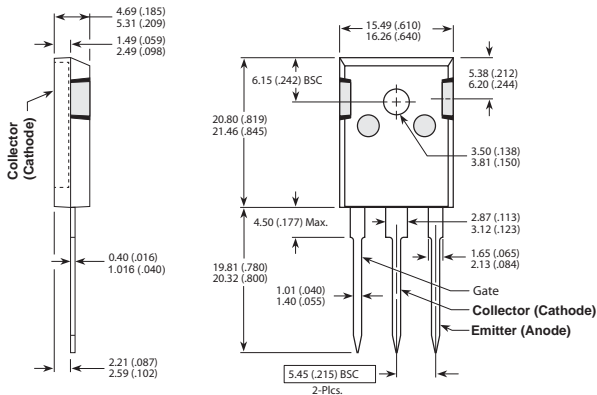

Figure 32. Diode Reverse Recovery Waveform Definition

**TO-247 Package Outline**

Ⓔ1 SAC: Tin, Silver, Copper



Dimensions in Millimeters (Inches)

**D<sup>3</sup>PAK Package Outline**

Ⓔ3 100% Sn Plated

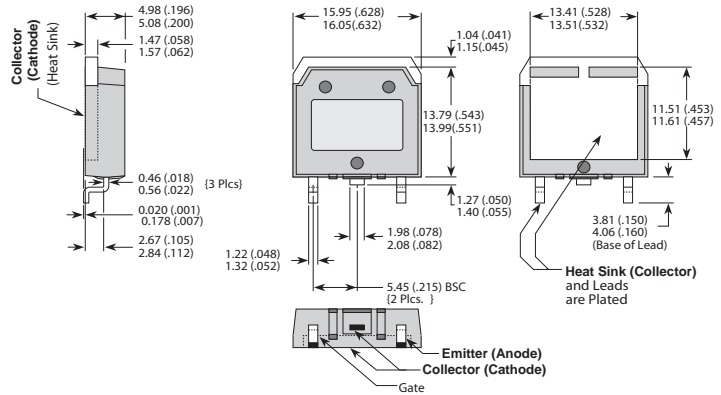

Dimensions in Millimeters (Inches)