

Rote Lumineszenzdiode
Red Emitter
Lead (Pb) Free Product - RoHS Compliant

SFH 4273

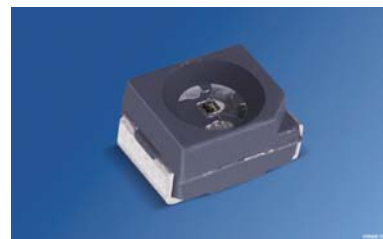

Wesentliche Merkmale

- Schwarz eingefärbtes TOPLED-Gehäuse
- Typische Emissionswellenlänge 660nm
- Verbesserte Abbildungseigenschaften durch Absorption der Seitenstrahlung
- Größe der Leuchtquelle 325 µm x 325 µm
- Feuchte-Empfindlichkeitsstufe 2 nach JEDEC Standard J-STD-020C

Anwendungen

- Miniaturlichtschranken und Lichtschranken über große Entfernungen
- Industrieelektronik
- „Messen/Steuern/Regeln“
- Sensorik
- Alarm- und Sicherungssysteme

Features

- Black colored TOPLED-package
- Typical peak wavelength 660nm
- Improved imaging characteristics due to absorption of side emission
- Size of emitting area 325µm x 325µm
- Moisture sensitivity level 2 according to JEDEC Standard J-STD-020C

Applications

- Miniature and long distance photointerrupters
- Industrial electronics
- For drive and control circuits
- Sensor technology
- Alarm and safety equipment

Typ Type	Bestellnummer Ordering Code	Strahlstärkegruppierung ¹⁾ ($I_F = 50 \text{ mA}$, $t_p = 20 \text{ ms}$) Radiant Intensity Grouping ¹⁾ $I_e \text{ (mW/sr)}$
SFH 4273	Q65110A2523	> 0.63 (typ. 1.0)

¹⁾ gemessen bei einem Raumwinkel $\Omega = 0.01 \text{ sr}$ / measured at a solid angle of $\Omega = 0.01 \text{ sr}$

Achtung: Es wird empfohlen, das Bauteil nicht bei extremer Luftfeuchtigkeit zu betreiben. Ist dies dennoch vorgesehen, setzen Sie sich bitte mit OSRAM OS in Verbindung

Attention: It is recommended not to operate the device under extreme humidity. If this is designated though, please contact OSRAM OS.

Grenzwerte ($T_A = 25\text{ °C}$)

Maximum Ratings

Bezeichnung Parameter	Symbol Symbol	Wert Value	Einheit Unit
Betriebs- und Lagertemperatur Operating and storage temperature range	$T_{op}; T_{stg}$	- 40 ... + 100	°C
Sperrspannung Reverse voltage	V_R	3	V
Durchlassstrom Forward current	I_F	50	mA
Stoßstrom, $\tau = 10\ \mu\text{s}$, $D = 0$ Surge current	I_{FSM}	1	A
Verlustleistung Power dissipation	P_{tot}	125	mW
Wärmewiderstand Sperrschicht - Umgebung bei Montage auf FR4 Platine, Padgröße je $16\ \text{mm}^2$ Thermal resistance junction - ambient mounted on PC-board (FR4), padsize $16\ \text{mm}^2$ each	R_{thJA}	450	K/W
Wärmewiderstand Sperrschicht - Lötstelle bei Montage auf Metall-Block Thermal resistance junction - soldering point, mounted on metal block	R_{thJS}	≈ 200	K/W

Kennwerte ($T_A = 25\text{ °C}$)

Characteristics

Bezeichnung Parameter	Symbol Symbol	Wert Value	Einheit Unit
Wellenlänge der Strahlung Wavelength at peak emission $I_F = 50\text{ mA}$, $t_p = 20\text{ ms}$	λ_{peak}	660	nm
Spektrale Bandbreite bei 50% von I_{max} Spectral bandwidth at 50% of I_{max} $I_F = 50\text{ mA}$	$\Delta\lambda$	25	nm
Abstrahlwinkel Half angle	φ	± 60	Grad deg.
Aktive Chipfläche Active chip area	A	0.106	mm ²
Abmessungen der aktiven Chipfläche Dimensions of the active chip area	$L \times B$ $L \times W$	0.325×0.325	mm ²
Schaltzeiten, I_e von 10% auf 90% und von 90% auf 10%, bei $I_F = 50\text{ mA}$, $R_L = 50\ \Omega$ Switching times, I_e from 10% to 90% and from 90% to 10%, $I_F = 50\text{ mA}$, $R_L = 50\ \Omega$	t_r , t_f	100	ns
Kapazität Capacitance $V_R = 0\text{ V}$, $f = 1\text{ MHz}$	C_o	30	pF
Durchlassspannung Forward voltage $I_F = 50\text{ mA}$, $t_p = 20\text{ ms}$	V_F	$2.1 (\leq 2.8)$	V
Sperrstrom, Reverse curr50mA50 mAent $V_R = 5\text{ V}$	I_R	$0.01 (\leq 1)$	μA
Gesamtstrahlungsfluss Total radiant flux $I_F = 50\text{ mA}$, $t_p = 20\text{ ms}$	Φ_e	5	mW
Temperaturkoeffizient von I_e bzw. Φ_e , $I_F = 50\text{ mA}$ Temperature coefficient of I_e or Φ_e , $I_F = 50\text{ mA}$	TC_I	- 0.4	%/K
Temperaturkoeffizient von V_F , $I_F = 50\text{ mA}$ Temperature coefficient of V_F , $I_F = 50\text{ mA}$	TC_V	- 3	mV/K
Temperaturkoeffizient von λ , $I_F = 50\text{ mA}$ Temperature coefficient of λ , $I_F = 50\text{ mA}$	TC_λ	+ 0.16	nm/K

Strahlstärke I_e in Achsrichtunggemessen bei einem Raumwinkel $\Omega = 0.01$ sr**Radiant Intensity I_e in Axial Direction**at a solid angle of $\Omega = 0.01$ sr

Bezeichnung Parameter	Symbol	Werte Values	Einheit Unit
Strahlstärke Radiant intensity $I_F = 50$ mA, $t_p = 20$ ms	I_e	> 0.63 (typ. 1.0)	mW/sr

Relative Spectral Emission

$I_{rel} = f(\lambda)$

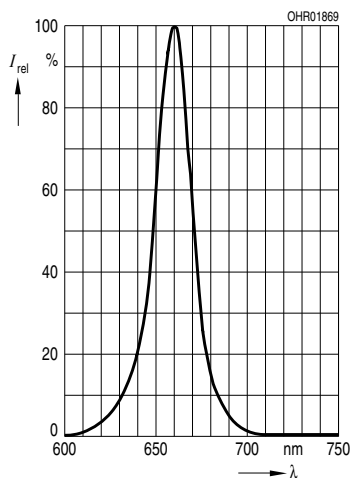

Radiant Intensity

$I_e / I_{e(50mA)} = f(I_F)$
Single pulse, $t_p = 20 \mu s$

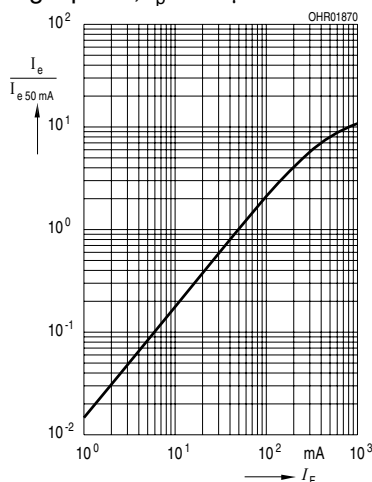

Max. Permissible Forward Current

$I_F = f(T_A)$

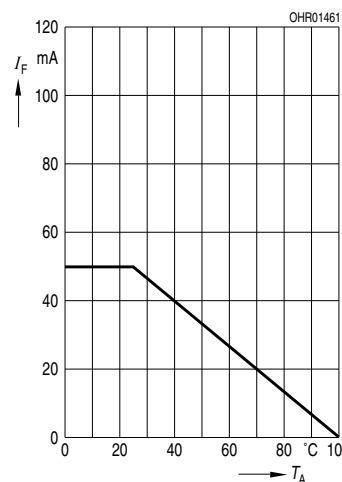

Forward Current

$I_F = f(V_F)$ single pulse, $t_p = 20 \mu s$

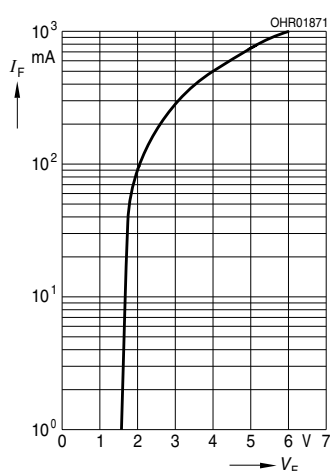

Permissible Pulse Handling Capability

$I_F = f(t_p, T_A = 25 \text{ °C})$
duty cycle $D = \text{parameter}$

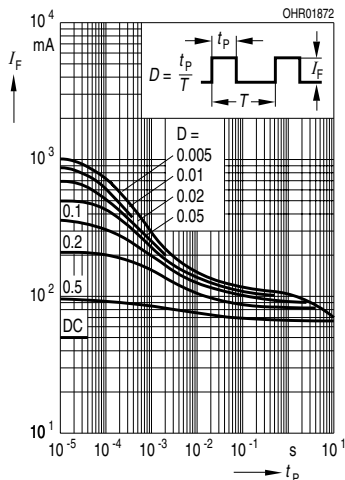

Radiation Characteristics

$I_{rel} = f(\varphi)$

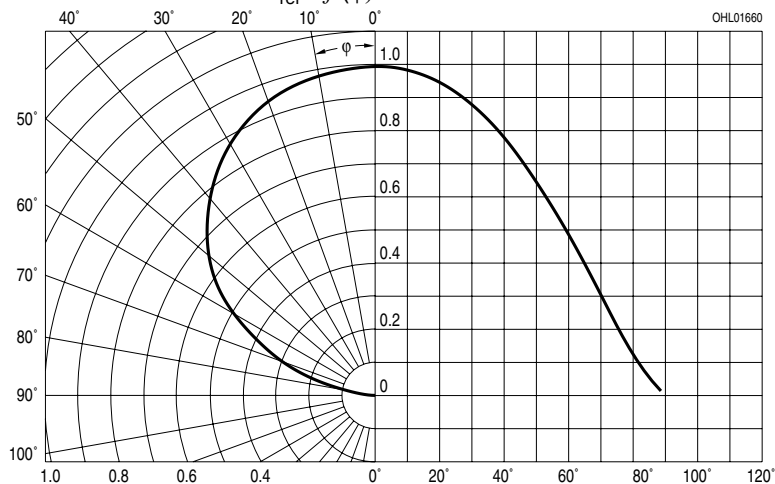

Maßzeichnung Package Outlines

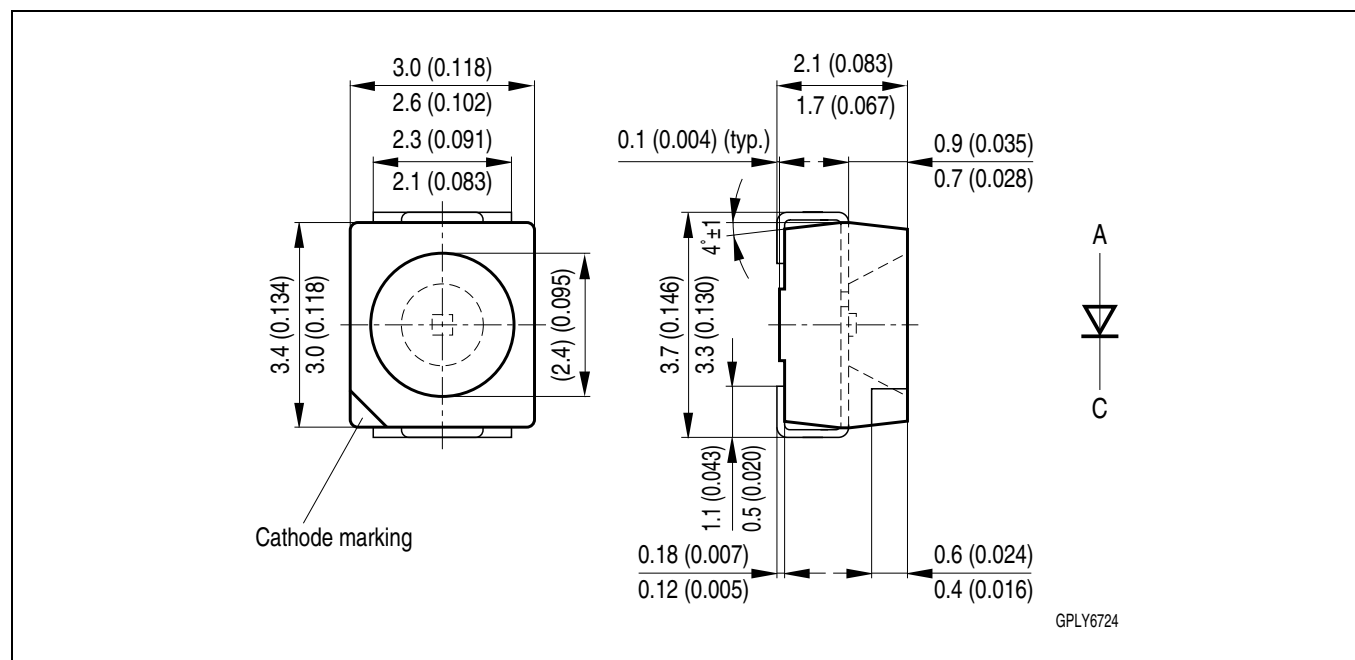

Maße in mm (inch) / Dimensions in mm (inch).

Gehäuse / Package	TOPLED®, klarer Verguss / TOPLED®, clear resin
Anschlussbelegung Pin configuration	abgeschrägte Ecke: Kathode beveled edge: Cathode
Farbe Color	schwarz black
Brechungsindex Verguss Refractive index resin	1.53 1.53

Empfohlenes Lötpaddesign
Recommended Solder Pad

Reflow Löten
Reflow Soldering

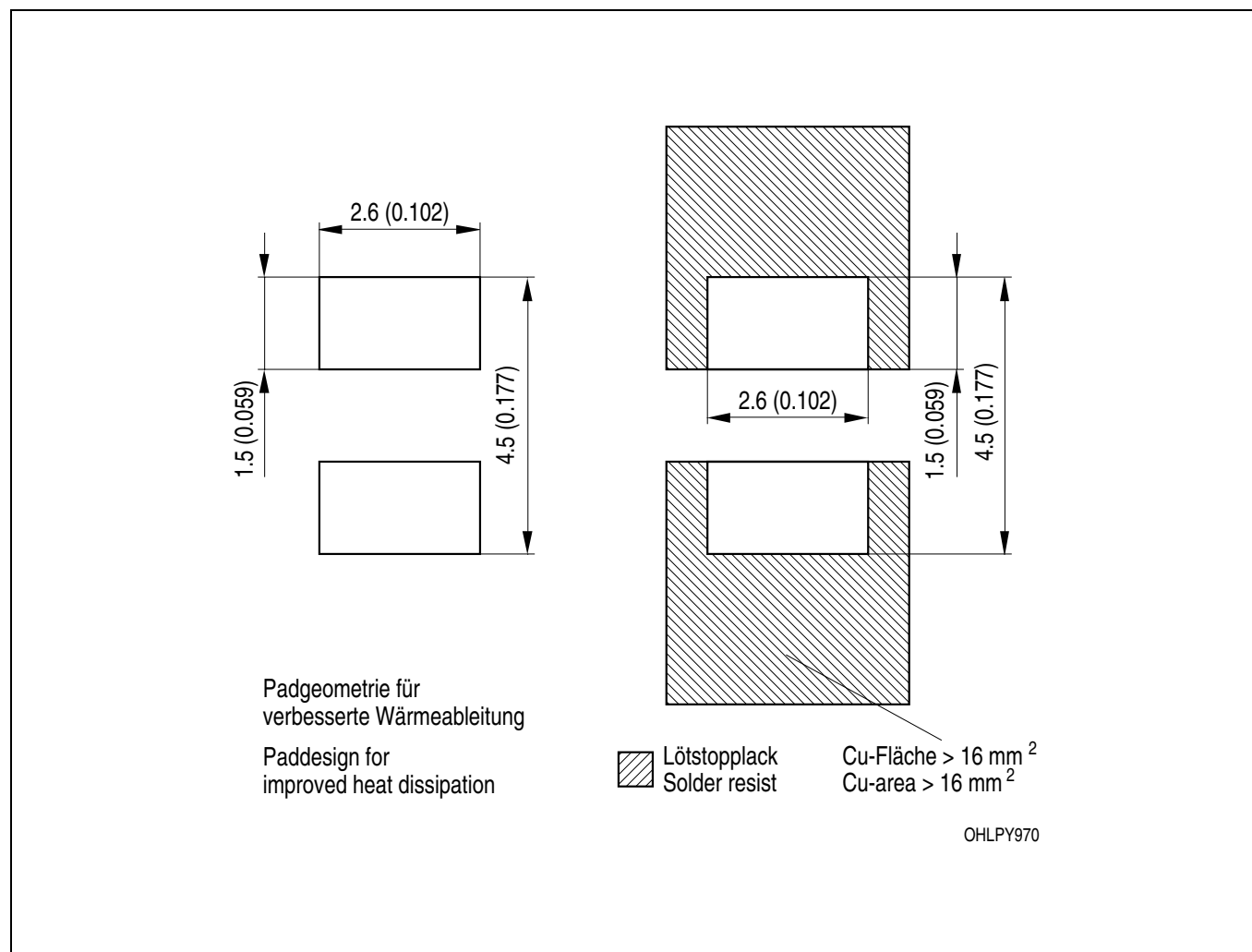

Maße in mm (inch) / Dimensions in mm (inch)

Lötbedingungen
Soldering Conditions
Reflow Lötprofil für bleifreies Löten
Reflow Soldering Profile for lead free soldering

Vorbehandlung nach JEDEC Level 2
 Preconditioning acc. to JEDEC Level 2
 (nach J-STD-020C)
 (acc. to J-STD-020C)

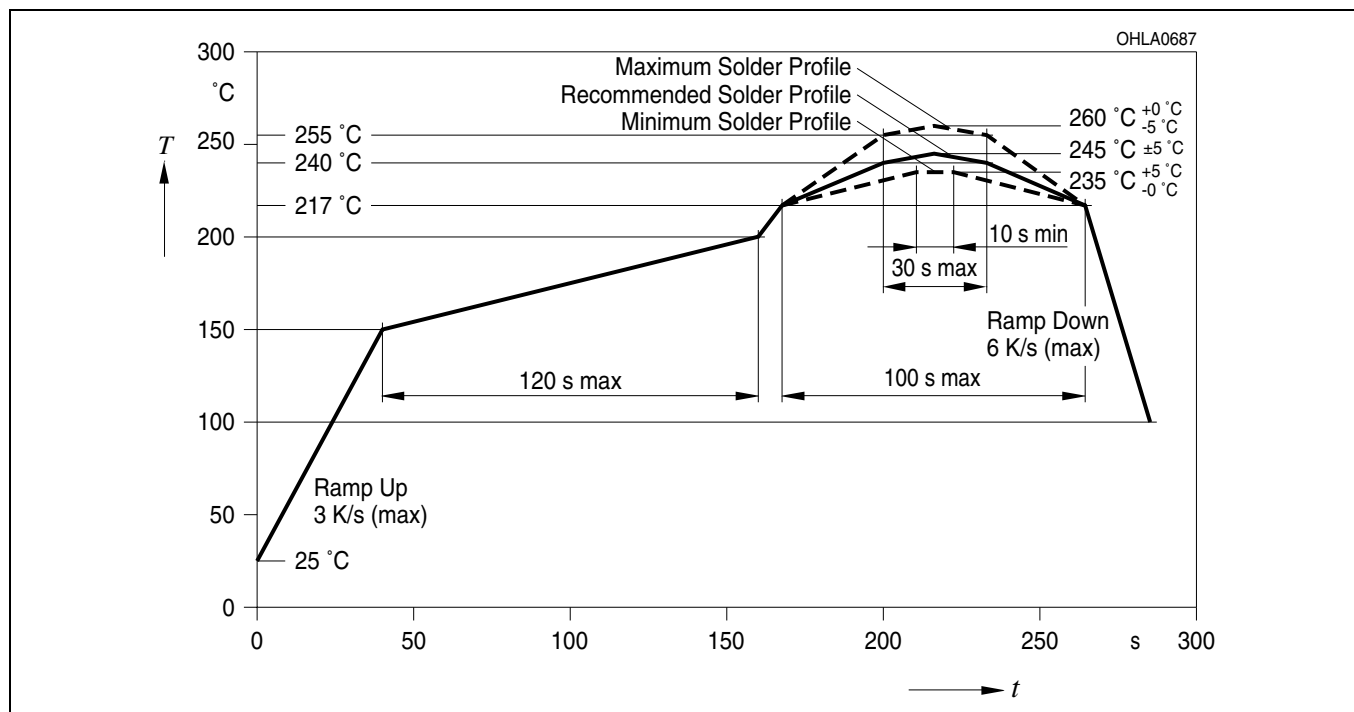

Wellenlöten (TTW)
TTW Soldering

(nach CECC 00802)
 (acc. to CECC 00802)

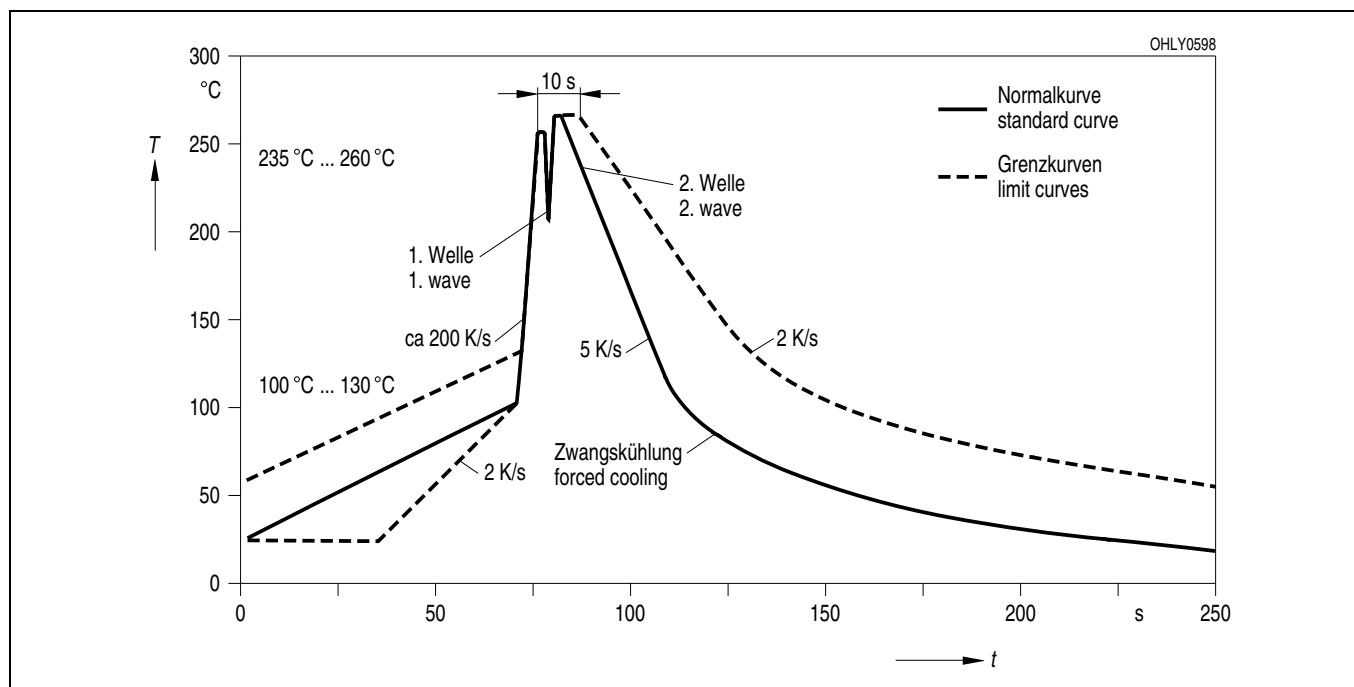

Published by
OSRAM Opto Semiconductors GmbH
Wernerwerkstrasse 2, D-93049 Regensburg
www.osram-os.com
© All Rights Reserved.

EU RoHS and China RoHS compliant product



此产品符合欧盟 RoHS 指令的要求；

按照中国的相关法规和标准，不含有毒有害物质或元素。

The information describes the type of component and shall not be considered as assured characteristics. Terms of delivery and rights to change design reserved. Due to technical requirements components may contain dangerous substances. For information on the types in question please contact our Sales Organization.

Packing

Please use the recycling operators known to you. We can also help you – get in touch with your nearest sales office. By agreement we will take packing material back, if it is sorted. You must bear the costs of transport. For packing material that is returned to us unsorted or which we are not obliged to accept, we shall have to invoice you for any costs incurred.

Components used in life-support devices or systems must be expressly authorized for such purpose! Critical components ¹, may only be used in life-support devices or systems ² with the express written approval of OSRAM OS.

¹ A critical component is a component used in a life-support device or system whose failure can reasonably be expected to cause the failure of that life-support device or system, or to affect its safety or effectiveness of that device or system.

² Life support devices or systems are intended (a) to be implanted in the human body, or (b) to support and/or maintain and sustain human life. If they fail, it is reasonable to assume that the health of the user may be endangered.