

4

3

DWG NO.

BHSL022-1

SH

1

REV.

N/C

1

This print and associated documents and the contained information are the confidential property of ELECTRONIC CABLE SPECIALISTS. Disclosure of, and/or reproduction of, all or part thereof or manufacture of any part from information contained on this print not specifically permitted by ELECTRONIC CABLE SPECIALISTS in writing is forbidden.

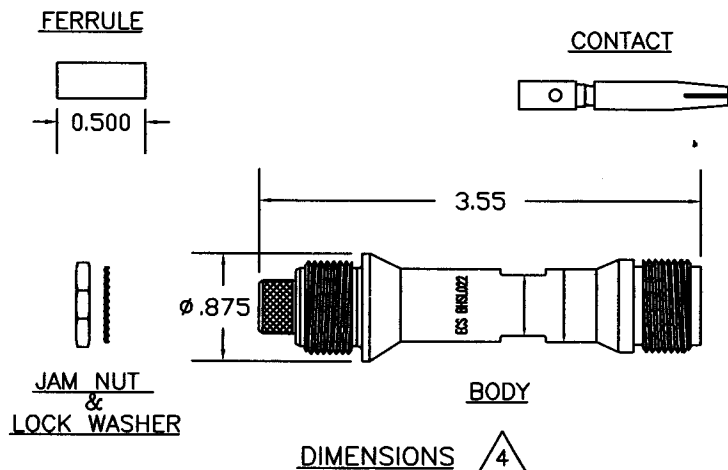

SPECIFICATIONS

ELECTRICAL

IMPEDANCE: 50 OHMS NOMINAL
 FREQUENCY RANGE: 0-4 GHz
 VSWR: 1.35:1 MAXIMUM
 INSERTION LOSS: .1 dB MAXIMUM DC TO 2 GHz
 WORKING VOLTAGE: 4500 VRMS @ SEA LEVEL
 DIELECTRIC WITHSTANDING: 5000 VRMS @ SEA LEVEL
 INSULATION RESISTANCE: 5000 MEGOHMS MINIMUM

MECHANICAL

CONNECTOR INTERFACE DIMENSION PER MIL-STD-348A FIGURE 317-2.
 TERMINATION STYLE: INNER CONTACT-SOLDER OR CRIMP
 OUTER CONTACT-FERRULE CRIMP
 CABLE RETENTION: 50 LBS

ENVIRONMENTAL

TEMPERATURE RATING: -65° TO +165° C
 CORROSION: MIL-STD-202, METHOD 101, COND. B
 MOISTURE RESISTANCE: MIL-STD-202, METHOD 106

MATERIALS
 BODY: BRASS PER ASTM B16
 FERRULE: ANNEALED BRASS PER ASTM B16 OR COPPER PER ASTM B124
 CABLE CONTACT: BERYLLIUM COPPER PER ASTM B196
 DIELECTRIC: TEFLON PER ASTM D1710
 JAM NUT: BRASS PER ASTM B16
 LOCK WASHER: STAINLESS

FINISHES

BODY, FERRULE: BRIGHT NICKEL PER QQ-N-290
 JAM NUT, LOCK WASHER: BRIGHT NICKEL PER QQ-N-290
 CABLE CONTACT: GOLD PER MIL-G-45204

INSTALLATION INSTRUCTIONS

1. BEGIN BY CUTTING THE CABLE OFF SQUARE.



2. WHEN USING AUTOMATIC STRIPPING EQUIPMENT, STRIP CABLE AS SHOWN STARTING WITH L1 AND ENDING WITH L3. TAKE CARE NOT TO NICK THE CONDUCTORS WHILE STRIPPING THE DIELECTRIC AND JACKET. IF AUTOMATIC STRIPPING EQUIPMENT IS NOT AVAILABLE, STRIP ONLY L1 AND L3 AND TRIM EXCESS BRAID AT STEP 10.

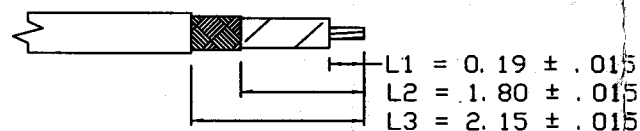

3. SLIDE THE FERRULE AND ADHESIVE SHRINK TUBING OVER THE END OF THE CABLE.



4. SOLDER THE CONTACT ONTO THE CENTER CONDUCTOR, PER MIL-STD-2000, USING 63Sn/37Pb SOLDER OR CRIMP WITH Y1757 DIE. ENSURE THE CONTACT IS BUTTED AGAINST THE CABLE DIELECTRIC. CLEAN ALL FLUX RESIDUES USING AN APPROPRIATE FLUX CLEANER.

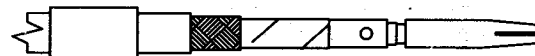

5. USING TWEEZERS, FOLD THE OUTER BRAID BACK OVER THE CABLE JACKET, LEAVING AS MUCH WEAVE AS POSSIBLE.

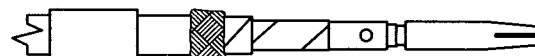

6. SLICE THE ALUMINUM/POLYESTER FOIL LENGTHWISE ABOUT EVERY 1/8". GENTLY ROTATE PIN TO SEPARATE THE FLAT FOIL BRAID AND ALUMINUM/POLYESTER FOIL FROM THE DIELECTRIC. USING TWEEZERS, FOLD BACK ALUMINUM/POLYESTER FOIL OVER THE OUTER BRAID.

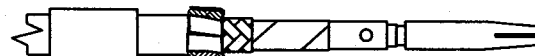

7. USING TWEEZERS, FOLD THE INNER BRAID BACK OVER THE OTHER SHIELDS, LEAVING AS MUCH WEAVE AS POSSIBLE. NOTE: DO NOT UNRAVEL DIELECTRIC WHEN PULLING BACK OUTER SHIELD.

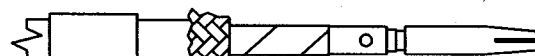

REVISIONS					
ECN	ZONE	REV.	DESCRIPTION	DATE	APPROVED
17196	-	N/C	NEW RELEASE.	3/14/03	<i>[Signature]</i>

8. SLIDE THE BODY OF THE CONNECTOR OVER THE END OF THE CABLE UNTIL THE NOTCH IN THE CONTACT SEATS WITH THE DIELECTRIC RIDGE INSIDE THE CONNECTOR BODY.

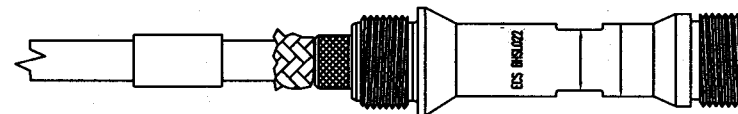

9. FOLD ALL THREE BRAIDS UP OVER THE NECK OF THE CONNECTOR BODY.

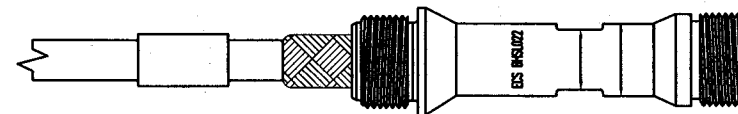

10. SLIDE THE FERRULE UP OVER THE SHIELDS AND AGAINST THE CONNECTOR BODY. TRIM AWAY ANY EXCESS BRAID. CRIMP THE FERRULE ONCE, NEXT TO THE BODY, USING THE M22520/5-21 DIE (A HEX) IN A M22520/5-01 TOOL FRAME.

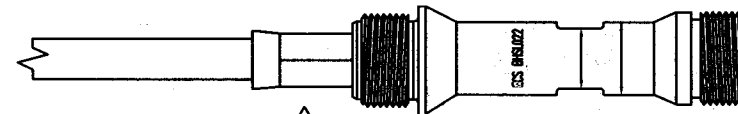

NOTES

- ALL DIMENSIONS ARE IN INCHES.
- ENSURE HEAT SHRINK IS INSTALLED PRIOR TO CRIMPING CONNECTOR.
- ADHESIVE HEAT SHRINK SHOULD BE APPLIED IN ACCORDANCE WITH ECS WORK INSTRUCTION W1007. CONTACT ECS FOR A COPY OF THIS WORK INSTRUCTION.
- CONNECTOR DIMENSIONS ARE FOR REFERENCE ONLY.

ALL LENGTHS IN INCHES		ELECTRONIC CABLE SPECIALISTS FRANKLIN, WI 53132 PHONE: (414) 421-5300	
APPROVALS	DATE	TITLE: CUSTOMER SPECIFICATION	
DRAWN BY: C CHAPMAN	3/14/03	HN STAIGHT BULKHEAD JACK FOR ECS CABLE 310801	
CHECKED BY: <i>[Signature]</i>	3/14/03	SIZE	CAGE CODE
DESIGNED BY:		B	66197
PROJECT ENG:		LEVEL	ECS PART NO.
ENG MGR: <i>[Signature]</i>	3/14/03		BHSL022
SCALE:	EFFECTIVITY:	SHEET: 1 OF 1	

4

3

2

1