

FEATURES

- **Low Noise:** $20\mu\text{V}_{\text{RMS}}$ (10Hz to 100kHz)
- **Output Current:** 300mA
- **Low Quiescent Current:** 30 μA
- **Wide Input Voltage Range:** 1.8V to 20V
- **Low Dropout Voltage:** 270mV
- **Very Low Shutdown Current:** < 1 μA
- No Protection Diodes Needed
- Fixed Output Voltages: 1.5V, 1.8V, 2.5V, 3V, 3.3V, 5V
- Adjustable Output from 1.22V to 20V
- Stable with 3.3 μF Output Capacitor
- Stable with Aluminum, Tantalum or Ceramic Capacitors
- Reverse Battery Protection
- No Reverse Current
- Overcurrent and Overtemperature Protected
- 8-Lead MSOP Package

APPLICATIONS

- Cellular Phones
- Battery-Powered Systems
- Noise-Sensitive Instrumentation Systems

DESCRIPTION

The LT[®]1962 series are micropower, low noise, low dropout regulators. The devices are capable of supplying 300mA of output current with a dropout voltage of 270mV. Designed for use in battery-powered systems, the low 30 μA quiescent current makes them an ideal choice. Quiescent current is well controlled; it does not rise in dropout as it does with many other regulators.

A key feature of the LT1962 regulators is low output noise. With the addition of an external 0.01 μF bypass capacitor, output noise drops to $20\mu\text{V}_{\text{RMS}}$ over a 10Hz to 100kHz bandwidth. The LT1962 regulators are stable with output capacitors as low as 3.3 μF . Small ceramic capacitors can be used without the series resistance required by other regulators.

Internal protection circuitry includes reverse battery protection, current limiting, thermal limiting and reverse current protection. The parts come in fixed output voltages of 1.5V, 1.8V, 2.5V, 3V, 3.3V and 5V, and as an adjustable device with a 1.22V reference voltage. The LT1962 regulators are available in the 8-lead MSOP package.

LT, LTC and LT are registered trademarks of Linear Technology Corporation.

TYPICAL APPLICATION

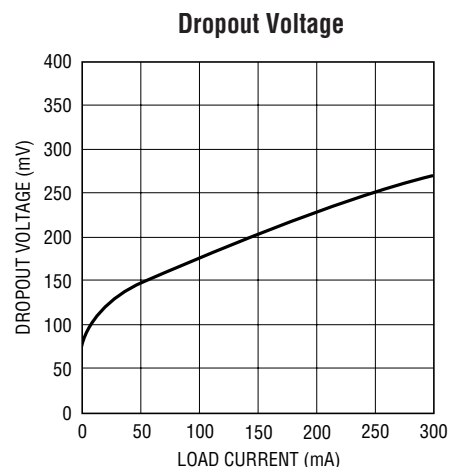
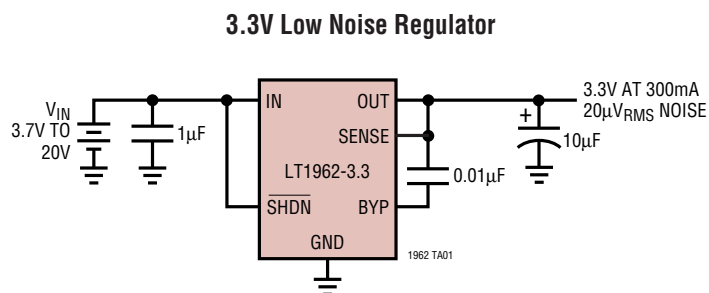

1962 TA02

ABSOLUTE MAXIMUM RATINGS

(Note 1)

IN Pin Voltage	±20V
OUT Pin Voltage	±20V
Input to Output Differential Voltage (Note 2)	±20V
SENSE Pin Voltage	±20V
ADJ Pin Voltage	±7V
BYP Pin Voltage	±0.6V
SHDN Pin Voltage	±20V
Output Short-Circuit Duration	Indefinite
Operating Junction Temperature Range (Note 3)	-40°C to 125°C
Storage Temperature Range	-65°C to 150°C
Lead Temperature (Soldering, 10 sec)	300°C

PACKAGE/ORDER INFORMATION

<p>TOP VIEW</p> <p>OUT 1 8 IN SENSE/ADJ* 2 7 NC BYP 3 6 NC GND 4 5 SHDN</p> <p>MS8 PACKAGE 8-LEAD PLASTIC MSOP</p> <p>*PIN 2: SENSE FOR LT1962-1.5/LT1962-1.8/ LT1962-2.5/LT1962-3/LT1962-3.3/LT1962-5. ADJ FOR LT1962</p> <p>T_{JMAX} = 150°C, θ_{JA} = 125°C/W</p> <p>SEE THE APPLICATIONS INFORMATION SECTION FOR ADDITIONAL INFORMATION ON THERMAL RESISTANCE</p>	ORDER PART NUMBER
	LT1962EMS8 LT1962EMS8-1.5 LT1962EMS8-1.8 LT1962EMS8-2.5 LT1962EMS8-3 LT1962EMS8-3.3 LT1962EMS8-5
	MS8 PART MARKING

MS8 PART MARKING

LTML	LTPQ
LTSZ	LTPS
LTTA	LTPR
LTPT	

Consult factory for parts specified with wider operating temperature ranges.

ELECTRICAL CHARACTERISTICS

The ● denotes specifications which apply over the full operating temperature range, otherwise specifications are T_A = 25°C. (Note 3)

PARAMETER	CONDITIONS	MIN	TYP	MAX	UNITS	
Minimum Operating Voltage	(LT1962) I _{LOAD} = 300mA (Notes 4, 12)	●	1.8	2.3	V	
Regulated Output Voltage (Notes 4, 5)	LT1962-1.5 V _{IN} = 2V, I _{LOAD} = 1mA 2.5V < V _{IN} < 20V, 1mA < I _{LOAD} < 300mA	●	1.485	1.500	1.515	V
	LT1962-1.8 V _{IN} = 2.3V, I _{LOAD} = 1mA 2.8V < V _{IN} < 20V, 1mA < I _{LOAD} < 300mA	●	1.782	1.800	1.818	V
	LT1962-2.5 V _{IN} = 3V, I _{LOAD} = 1mA 3.5V < V _{IN} < 20V, 1mA < I _{LOAD} < 300mA	●	2.475	2.500	2.525	V
	LT1962-3 V _{IN} = 3.5V, I _{LOAD} = 1mA 4V < V _{IN} < 20V, 1mA < I _{LOAD} < 300mA	●	2.970	3.000	3.030	V
	LT1962-3.3 V _{IN} = 3.8V, I _{LOAD} = 1mA 4.3V < V _{IN} < 20V, 1mA < I _{LOAD} < 300mA	●	3.267	3.300	3.333	V
	LT1962-5 V _{IN} = 5.5V, I _{LOAD} = 1mA 6V < V _{IN} < 20V, 1mA < I _{LOAD} < 300mA	●	4.950	5.000	5.050	V
	ADJ Pin Voltage (Notes 4, 5)	LT1962 V _{IN} = 2V, I _{LOAD} = 1mA 2.3V < V _{IN} < 20V, 1mA < I _{LOAD} < 300mA	●	1.208	1.220	1.232
Line Regulation	LT1962-1.5 ΔV _{IN} = 2V to 20V, I _{LOAD} = 1mA	●	1	5	mV	
	LT1962-1.8 ΔV _{IN} = 2.3V to 20V, I _{LOAD} = 1mA	●	1	5	mV	
	LT1962-2.5 ΔV _{IN} = 3V to 20V, I _{LOAD} = 1mA	●	1	5	mV	
	LT1962-3 ΔV _{IN} = 3.5V to 20V, I _{LOAD} = 1mA	●	1	5	mV	
	LT1962-3.3 ΔV _{IN} = 3.8V to 20V, I _{LOAD} = 1mA	●	1	5	mV	
	LT1962-5 ΔV _{IN} = 5.5V to 20V, I _{LOAD} = 1mA	●	1	5	mV	
	LT1962 (Note 4) ΔV _{IN} = 2V to 20V, I _{LOAD} = 1mA	●	1	5	mV	
Load Regulation	LT1962-1.5 V _{IN} = 2.5V, ΔI _{LOAD} = 1mA to 300mA	●	3	8	mV	
	LT1962-1.8 V _{IN} = 2.8V, ΔI _{LOAD} = 1mA to 300mA	●	4	9	mV	

ELECTRICAL CHARACTERISTICS

The ● denotes specifications which apply over the full operating temperature range, otherwise specifications are $T_A = 25^\circ\text{C}$. (Note 3)

PARAMETER	CONDITIONS		MIN	TYP	MAX	UNITS
Load Regulation	LT1962-2.5	$V_{IN} = 3.5\text{V}$, $\Delta I_{LOAD} = 1\text{mA}$ to 300mA $V_{IN} = 3.5\text{V}$, $\Delta I_{LOAD} = 1\text{mA}$ to 300mA	●	5	12 25	mV mV
	LT1962-3	$V_{IN} = 4\text{V}$, $\Delta I_{LOAD} = 1\text{mA}$ to 300mA $V_{IN} = 4\text{V}$, $\Delta I_{LOAD} = 1\text{mA}$ to 300mA	●	7	15 30	mV mV
	LT1962-3.3	$V_{IN} = 4.3\text{V}$, $\Delta I_{LOAD} = 1\text{mA}$ to 300mA $V_{IN} = 4.3\text{V}$, $\Delta I_{LOAD} = 1\text{mA}$ to 300mA	●	7	17 33	mV mV
	LT1962-5	$V_{IN} = 6\text{V}$, $\Delta I_{LOAD} = 1\text{mA}$ to 300mA $V_{IN} = 6\text{V}$, $\Delta I_{LOAD} = 1\text{mA}$ to 300mA	●	12	25 50	mV mV
	LT1962 (Note 4)	$V_{IN} = 2.3\text{V}$, $\Delta I_{LOAD} = 1\text{mA}$ to 300mA $V_{IN} = 2.3\text{V}$, $\Delta I_{LOAD} = 1\text{mA}$ to 300mA	●	2	6 12	mV mV
Dropout Voltage $V_{IN} = V_{OUT(NOMINAL)}$ (Notes 6, 7, 12)	$I_{LOAD} = 10\text{mA}$ $I_{LOAD} = 10\text{mA}$	●		0.10	0.15 0.21	V V
	$I_{LOAD} = 50\text{mA}$ $I_{LOAD} = 50\text{mA}$	●		0.15	0.20 0.28	V V
	$I_{LOAD} = 100\text{mA}$ $I_{LOAD} = 100\text{mA}$	●		0.18	0.24 0.33	V V
	$I_{LOAD} = 300\text{mA}$ $I_{LOAD} = 300\text{mA}$	●		0.27	0.33 0.43	V V
GND Pin Current $V_{IN} = V_{OUT(NOMINAL)}$ (Notes 6, 8)	$I_{LOAD} = 0\text{mA}$	●		30	75	μA
	$I_{LOAD} = 1\text{mA}$	●		65	120	μA
	$I_{LOAD} = 50\text{mA}$	●		1.1	1.6	mA
	$I_{LOAD} = 100\text{mA}$	●		2	3	mA
	$I_{LOAD} = 300\text{mA}$	●		8	12	mA
Output Voltage Noise	$C_{OUT} = 10\mu\text{F}$, $C_{BYP} = 0.01\mu\text{F}$, $I_{LOAD} = 300\text{mA}$, $\text{BW} = 10\text{Hz}$ to 100kHz			20		μV_{RMS}
ADJ Pin Bias Current	(Notes 4, 9)			30	100	nA
Shutdown Threshold	$V_{OUT} = \text{Off to On}$	●		0.8	2	V
	$V_{OUT} = \text{On to Off}$	●	0.25	0.65		V
SHDN Pin Current (Note 10)	$V_{SHDN} = 0\text{V}$			0.01	0.5	μA
	$V_{SHDN} = 20\text{V}$			1	5	μA
Quiescent Current in Shutdown	$V_{IN} = 6\text{V}$, $V_{SHDN} = 0\text{V}$			0.1	1	μA
Ripple Rejection	$V_{IN} - V_{OUT} = 1.5\text{V}$ (Avg), $V_{RIPPLE} = 0.5\text{V}_{P-P}$, $f_{RIPPLE} = 120\text{Hz}$, $I_{LOAD} = 300\text{mA}$		55	65		dB
Current Limit	$V_{IN} = 7\text{V}$, $V_{OUT} = 0\text{V}$			700		mA
	$V_{IN} = V_{OUT(NOMINAL)} + 1\text{V}$, $\Delta V_{OUT} = -0.1\text{V}$	●	320			mA
Input Reverse Leakage Current	$V_{IN} = -20\text{V}$, $V_{OUT} = 0\text{V}$	●			1	mA
Reverse Output Current (Note 11)	LT1962-1.5	$V_{OUT} = 1.5\text{V}$, $V_{IN} < 1.5\text{V}$		10	20	μA
	LT1962-1.8	$V_{OUT} = 1.8\text{V}$, $V_{IN} < 1.8\text{V}$		10	20	μA
	LT1962-2.5	$V_{OUT} = 2.5\text{V}$, $V_{IN} < 2.5\text{V}$		10	20	μA
	LT1962-3	$V_{OUT} = 3\text{V}$, $V_{IN} < 3\text{V}$		10	20	μA
	LT1962-3.3	$V_{OUT} = 3.3\text{V}$, $V_{IN} < 3.3\text{V}$		10	20	μA
	LT1962-5	$V_{OUT} = 5\text{V}$, $V_{IN} < 5\text{V}$		10	20	μA
LT1962 (Note 4)	$V_{OUT} = 1.22\text{V}$, $V_{IN} < 1.22\text{V}$		5	10	μA	

Note 1: Absolute Maximum Ratings are those values beyond which the life of a device may be impaired.

Note 2: Absolute maximum input to output differential voltage cannot be achieved with all combinations of rated IN pin and OUT pin voltages. With the IN pin at 20V, the OUT pin may not be pulled below 0V. The total measured voltage from in to out can not exceed $\pm 20\text{V}$.

Note 3: The LT1962 regulators are tested and specified under pulse load conditions such that $T_J \approx T_A$. The LT1962 is 100% tested at $T_A = 25^\circ\text{C}$. Performance at -40°C and 125°C is assured by design, characterization and correlation with statistical process controls.

Note 4: The LT1962 (adjustable version) is tested and specified for these conditions with the ADJ pin connected to the OUT pin.

ELECTRICAL CHARACTERISTICS

Note 5: Operating conditions are limited by maximum junction temperature. The regulated output voltage specification will not apply for all possible combinations of input voltage and output current. When operating at maximum input voltage, the output current range must be limited. When operating at maximum output current, the input voltage range must be limited.

Note 6: To satisfy requirements for minimum input voltage, the LT1962 (adjustable version) is tested and specified for these conditions with an external resistor divider (two 250k resistors) for an output voltage of 2.44V. The external resistor divider will add a 5 μ A DC load on the output.

Note 7: Dropout voltage is the minimum input to output voltage differential needed to maintain regulation at a specified output current. In dropout, the output voltage will be equal to: $V_{IN} - V_{DROPOUT}$.

Note 8: GND pin current is tested with $V_{IN} = V_{OUT(NOMINAL)}$ or $V_{IN} = 2.3V$ (whichever is greater) and a current source load. This means the device is

tested while operating in its dropout region. This is the worst-case GND pin current. The GND pin current will decrease slightly at higher input voltages.

Note 9: \overline{ADJ} pin bias current flows into the \overline{ADJ} pin.

Note 10: \overline{SHDN} pin current flows into the \overline{SHDN} pin. This current is included in the specification for GND pin current.

Note 11: Reverse output current is tested with the IN pin grounded and the OUT pin forced to the rated output voltage. This current flows into the OUT pin and out the GND pin.

Note 12: For the LT1962, LT1962-1.5 and LT1962-1.8 dropout voltage will be limited by the minimum input voltage specification under some output voltage/load conditions. See the curve of Minimum Input Voltage in the Typical Performance Characteristics. For other fixed voltage versions of the LT1962, the minimum input voltage is limited by the dropout voltage.

TYPICAL PERFORMANCE CHARACTERISTICS

Typical Dropout Voltage

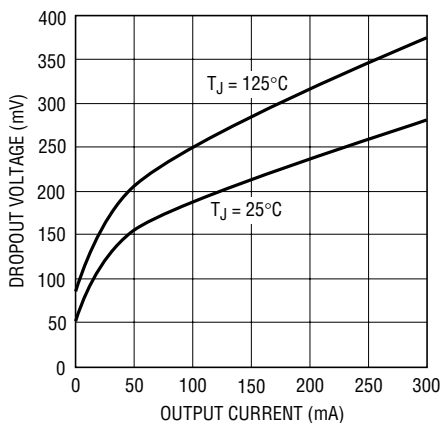

1962 G01

Guaranteed Dropout Voltage

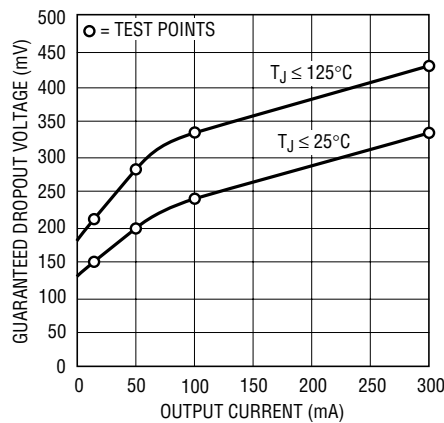

1962 G02

Dropout Voltage

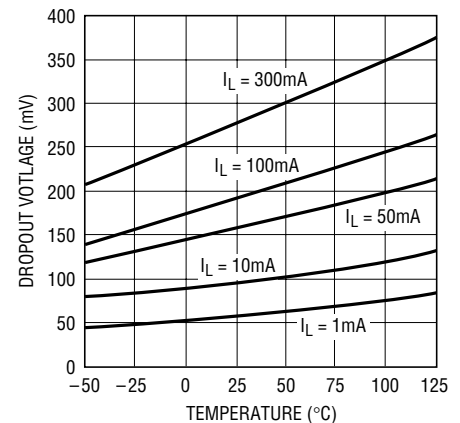

1962 G03

Quiescent Current

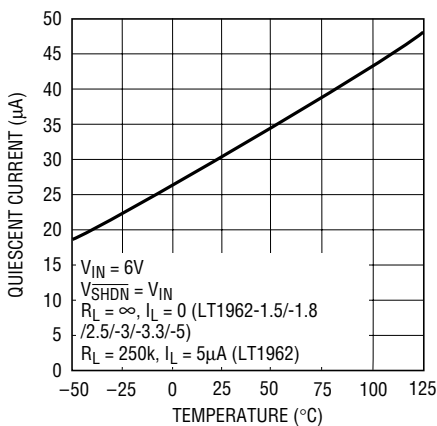

1962 G04

LT1962-1.5 Output Voltage

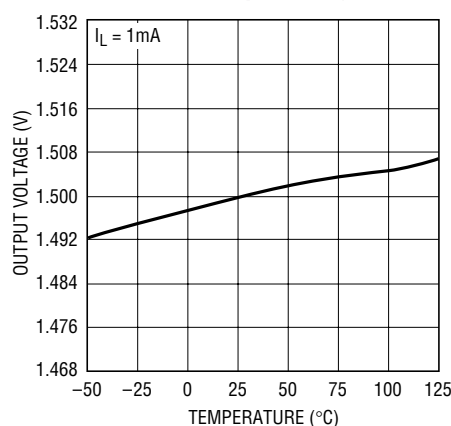

1962 G05

LT1962-1.8 Output Voltage

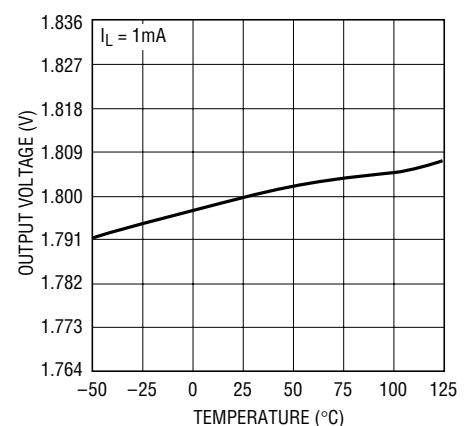

1962 G06

TYPICAL PERFORMANCE CHARACTERISTICS

LT1962-2.5 Output Voltage

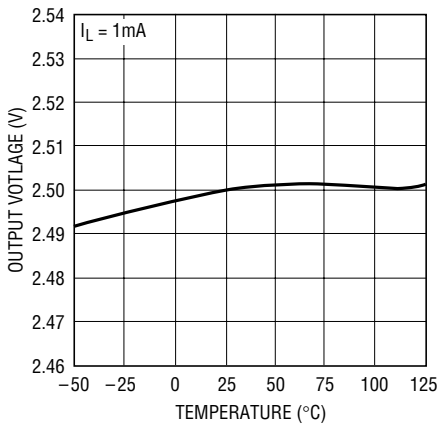

1962 G07

LT1962-3 Output Voltage

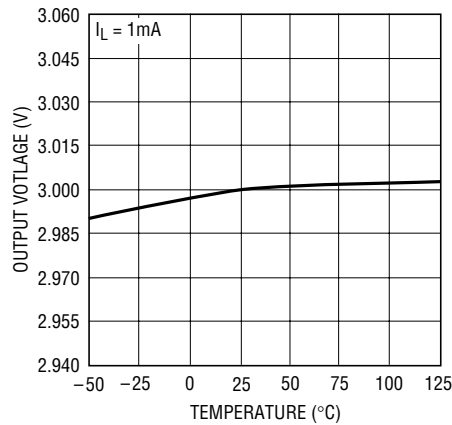

1962 G08

LT1962-3.3 Output Voltage

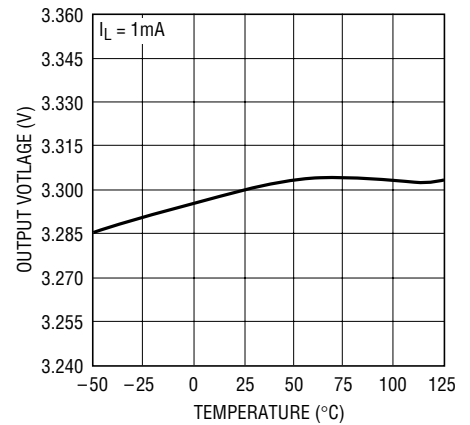

1962 G09

LT1962-5 Output Voltage

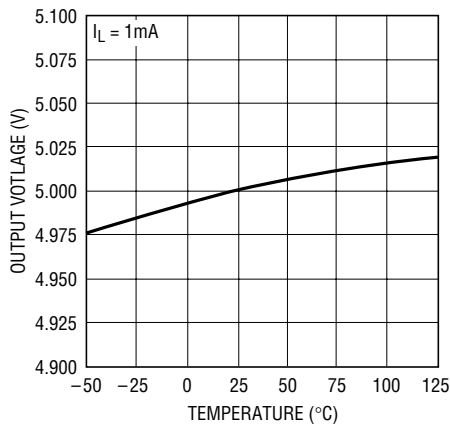

1962 G10

LT1962 ADJ Pin Voltage

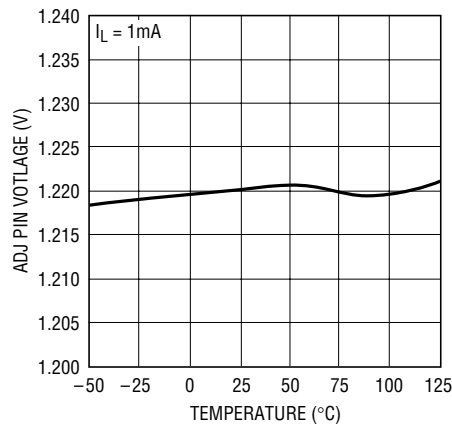

1962 G11

LT1962-1.5 Quiescent Current

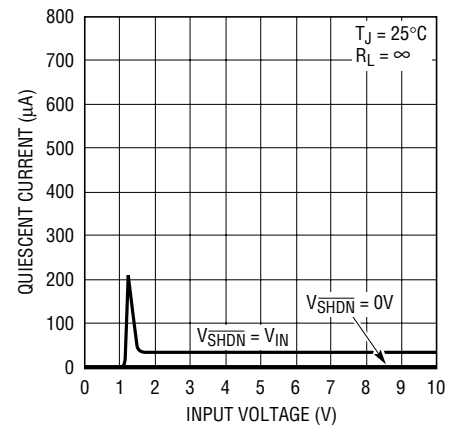

1962 G12

LT1962-1.8 Quiescent Current

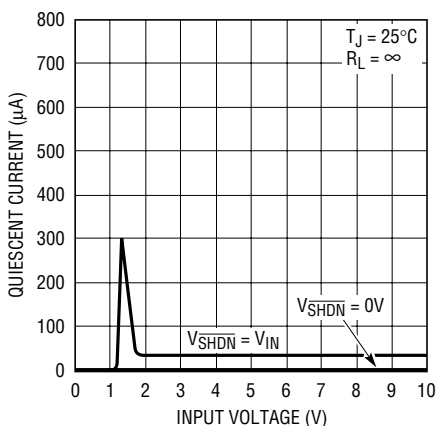

1962 G13

LT1962-2.5 Quiescent Current

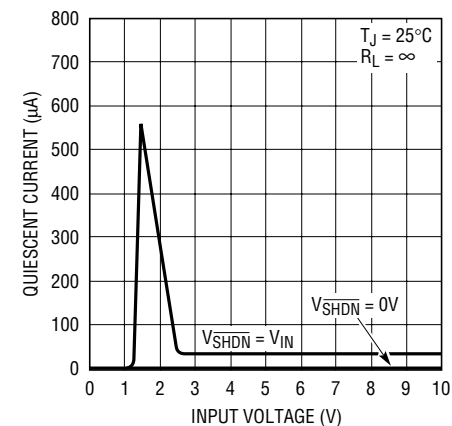

1962 G14

LT1962-3 Quiescent Current

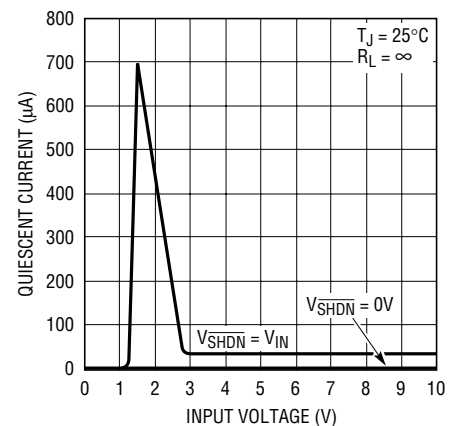

1962 G15

TYPICAL PERFORMANCE CHARACTERISTICS

LT1962-3.3 Quiescent Current

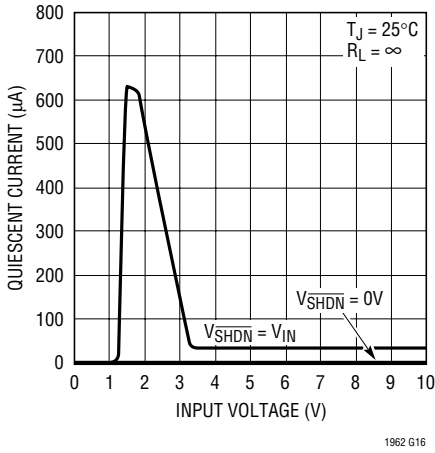

1962 G16

LT1962-5 Quiescent Current

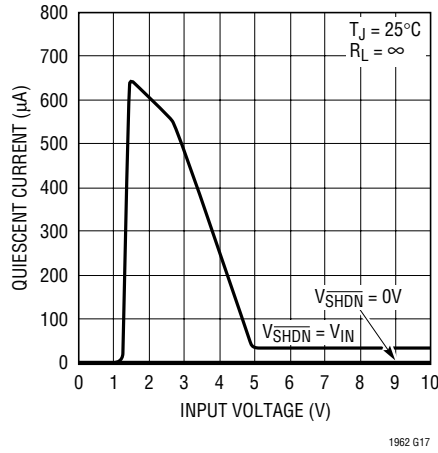

1962 G17

LT1962 Quiescent Current

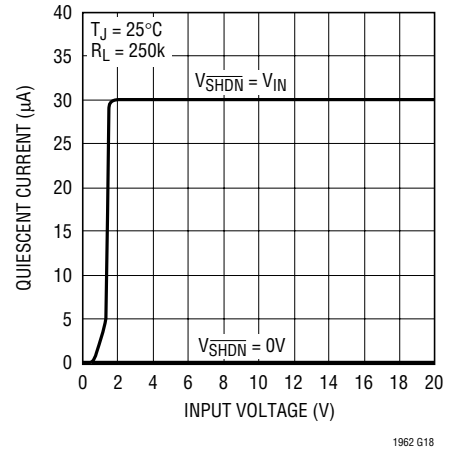

1962 G18

LT1962-1.5 GND Pin Current

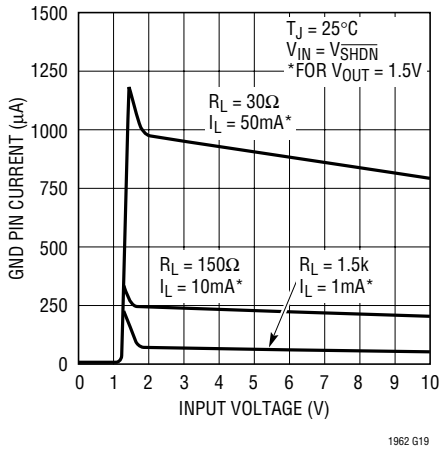

1962 G19

LT1962-1.8 GND Pin Current

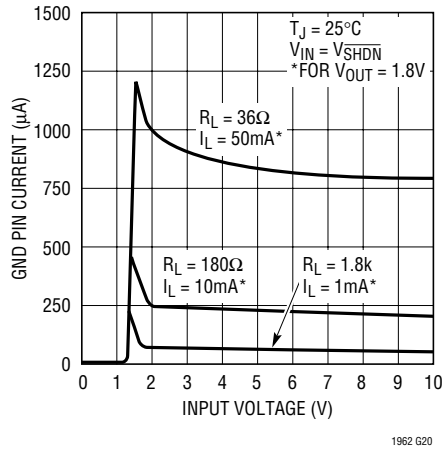

1962 G20

LT1962-2.5 GND Pin Current

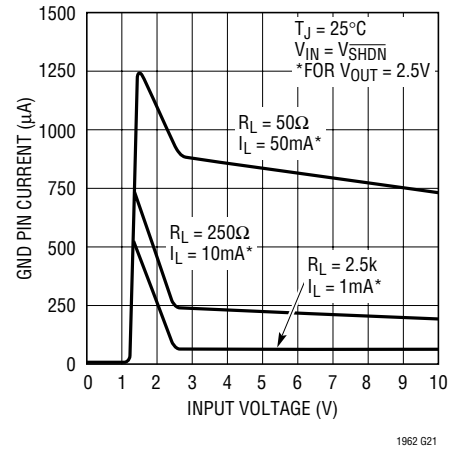

1962 G21

LT1962-3 GND Pin Current

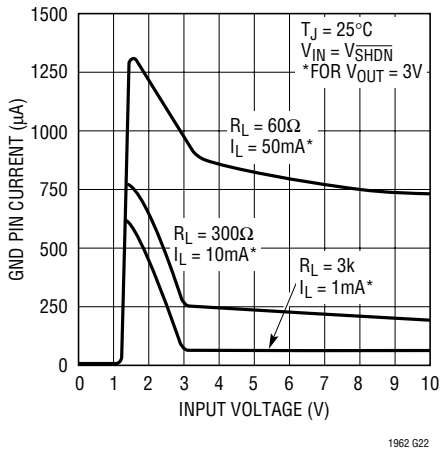

1962 G22

LT1962-3.3 GND Pin Current

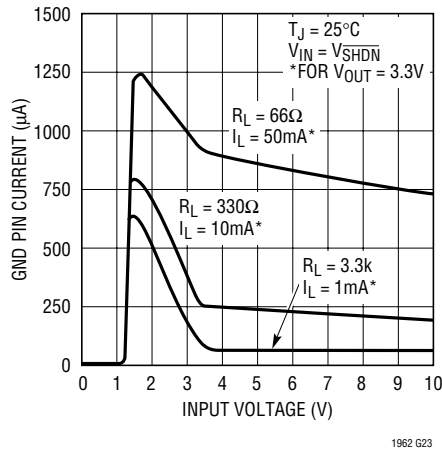

1962 G23

LT1962-5 GND Pin Current

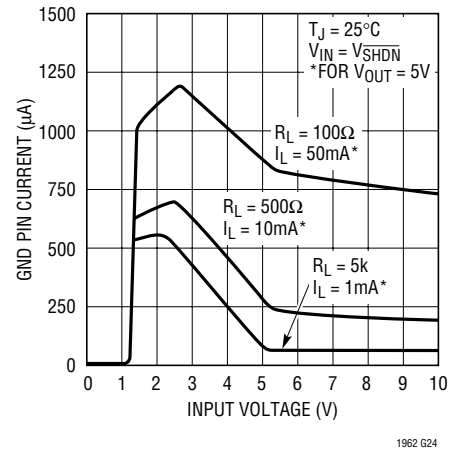

1962 G24

TYPICAL PERFORMANCE CHARACTERISTICS

LT1962 GND Pin Current

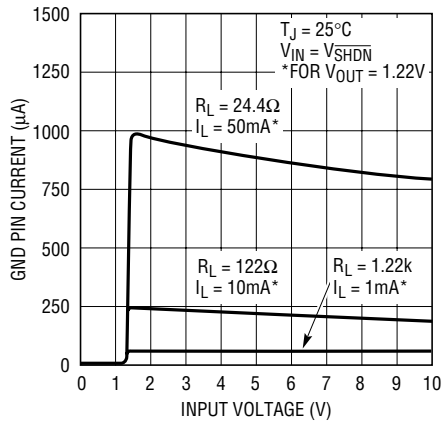

1962 G25

LT1962-1.5 GND Pin Current

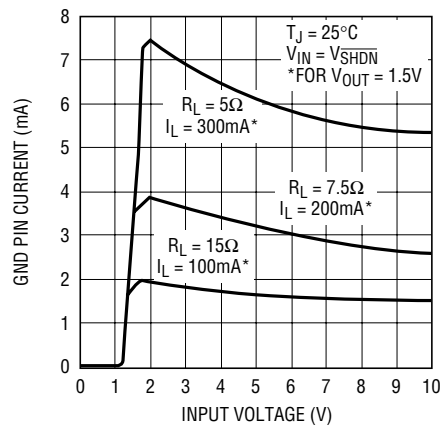

1962 G26

LT1962-1.8 GND Pin Current

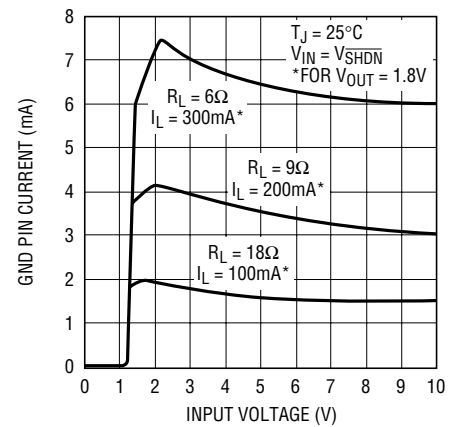

1962 G27

LT1962-2.5 GND Pin Current

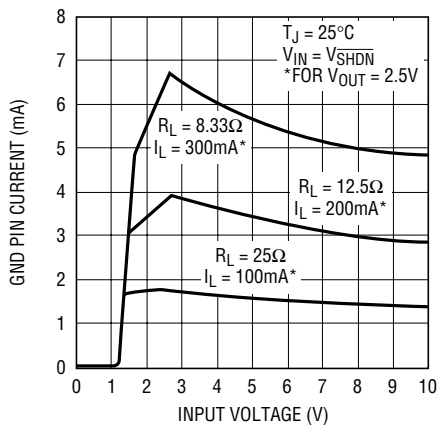

1962 G28

LT1962-3 GND Pin Current

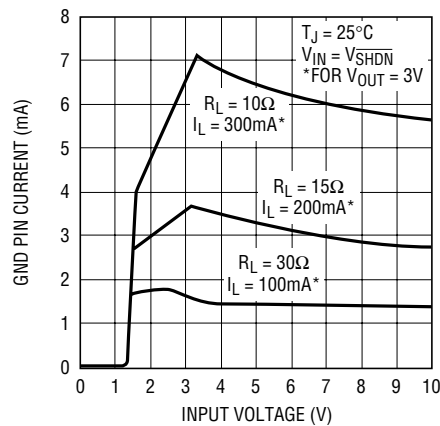

1962 G29

LT1962-3.3 GND Pin Current

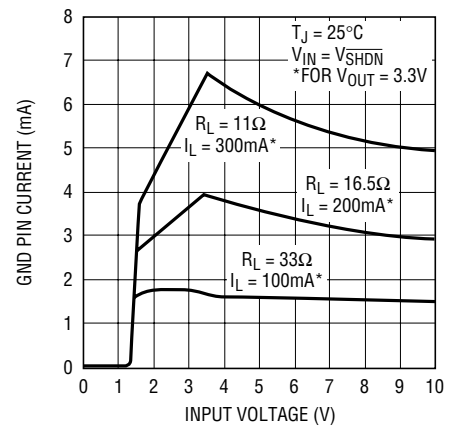

1962 G30

LT1962-5 GND Pin Current

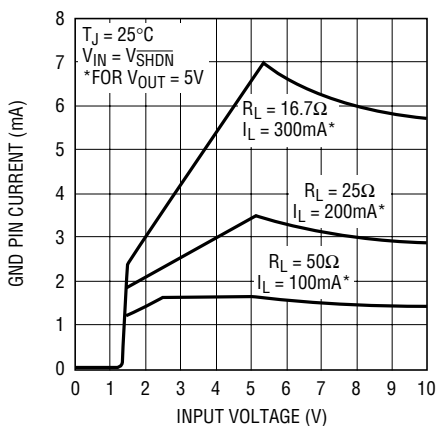

1962 G31

LT1962 GND Pin Current

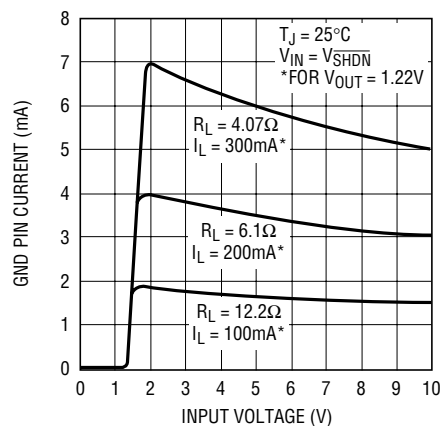

1962 G32

GND Pin Current vs I_{LOAD}

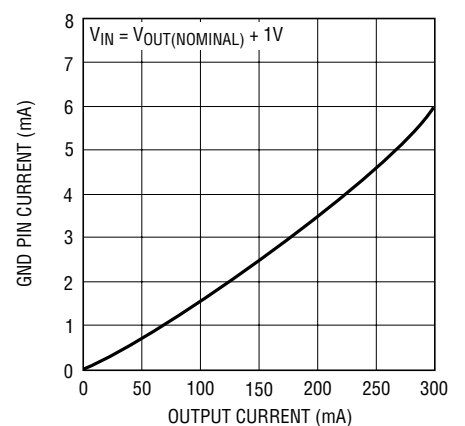

1962 G33

TYPICAL PERFORMANCE CHARACTERISTICS

SHDN Pin Threshold (On-to-Off)

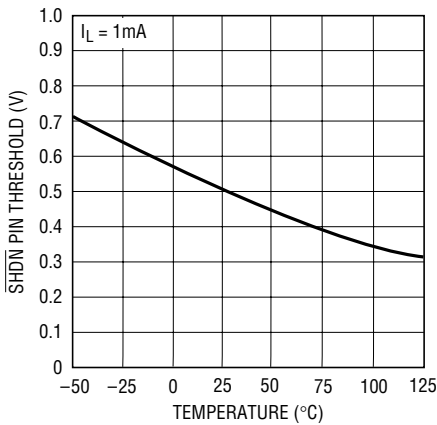

SHDN Pin Threshold (Off-to-On)

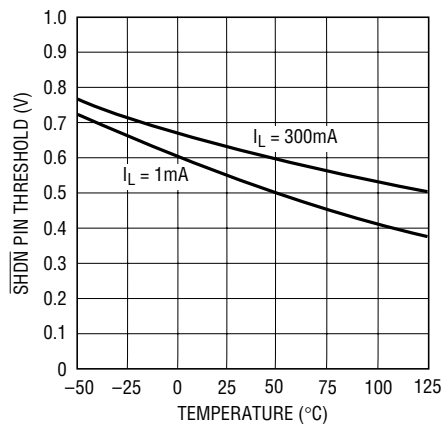

SHDN Pin Input Current

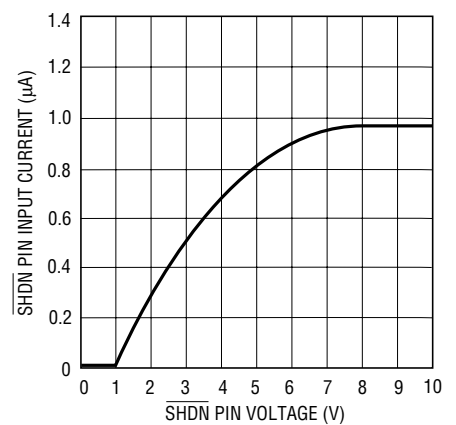

SHDN Pin Input Current

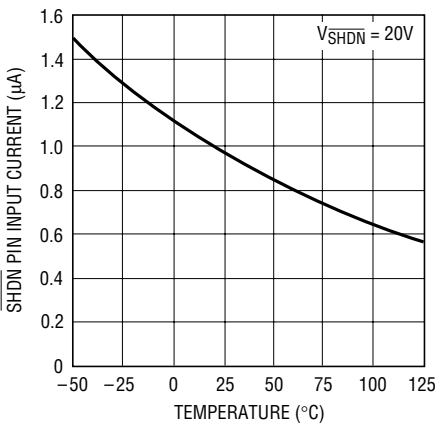

ADJ Pin Bias Current

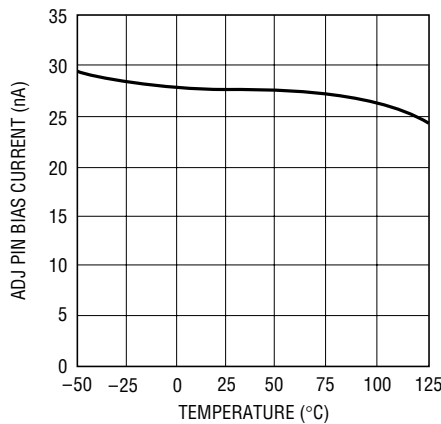

Current Limit

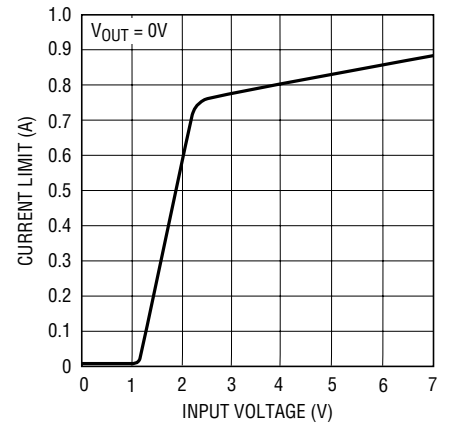

Current Limit

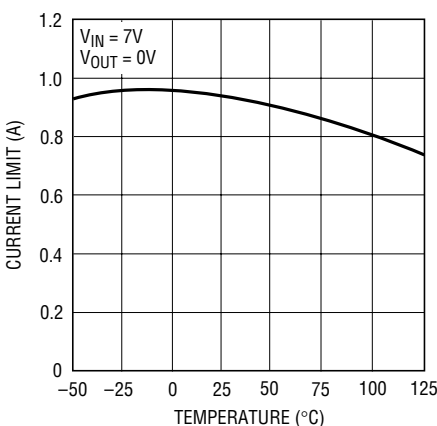

Reverse Output Current

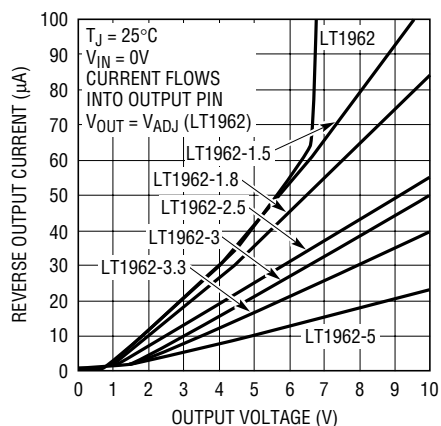

Reverse Output Current

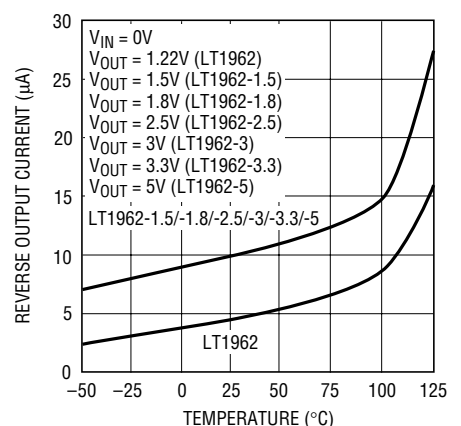

TYPICAL PERFORMANCE CHARACTERISTICS

Input Ripple Rejection

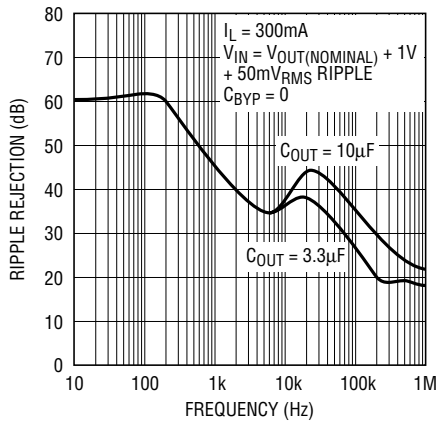

1962 G43

Input Ripple Rejection

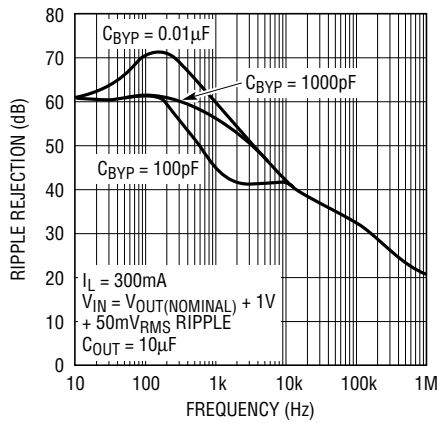

1962 G44

Ripple Rejection

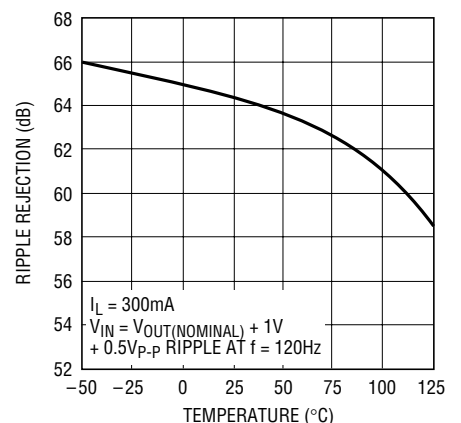

1962 G45

LT1962 Minimum Input Voltage

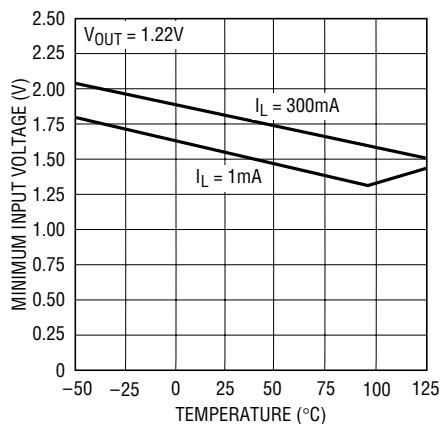

1962 G46

Load Regulation

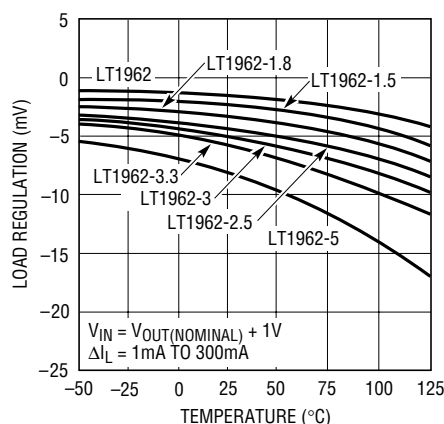

1962 G47

Output Noise Spectral Density

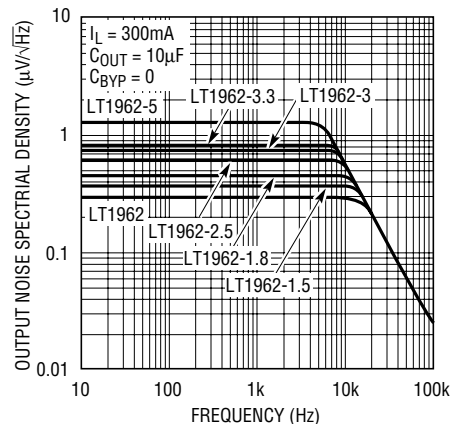

1962 G48

Output Noise Spectral Density

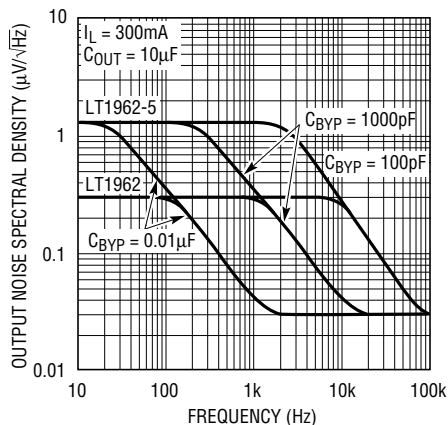

1962 G49

RMS Output Noise vs Bypass Capacitor

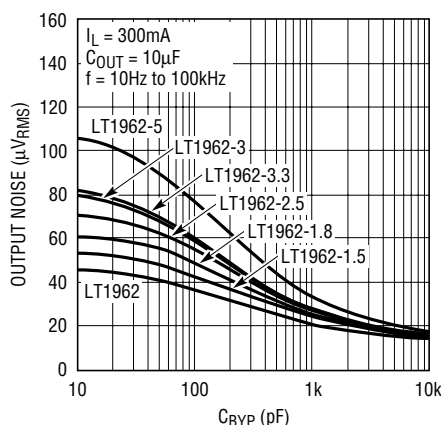

1962 G50

RMS Output Noise vs Load Current (10Hz to 100kHz)

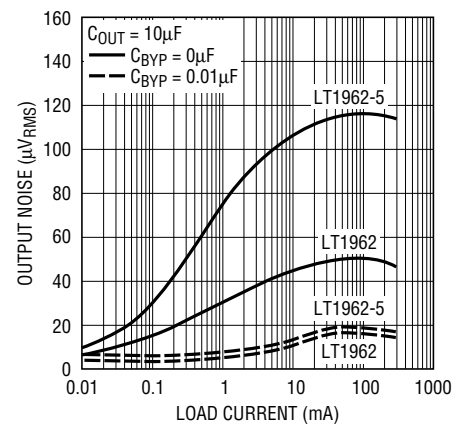

1962 G51

TYPICAL PERFORMANCE CHARACTERISTICS

LT1962-5 10Hz to 100kHz
Output Noise ($C_{BYP} = 0$)

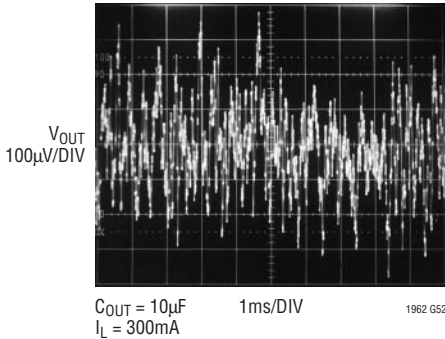

LT1962-5 10Hz to 100kHz
Output Noise ($C_{BYP} = 100pF$)

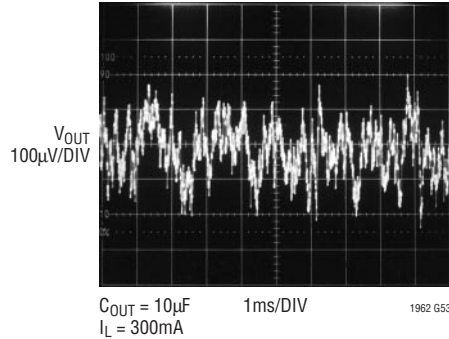

LT1962-5 10Hz to 100kHz
Output Noise ($C_{BYP} = 1000pF$)

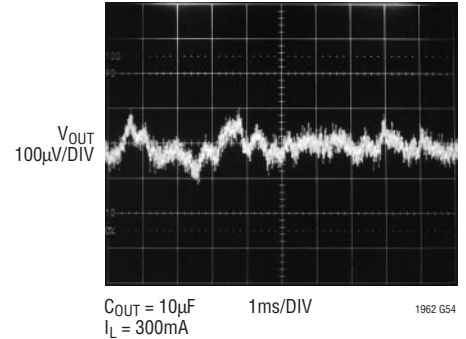

LT1962-5 10Hz to 100kHz
Output Noise ($C_{BYP} = 0.01µF$)

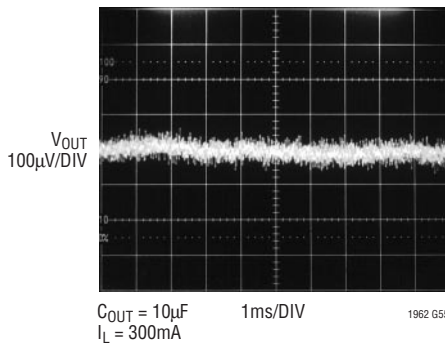

LT1962-5 Transient Response

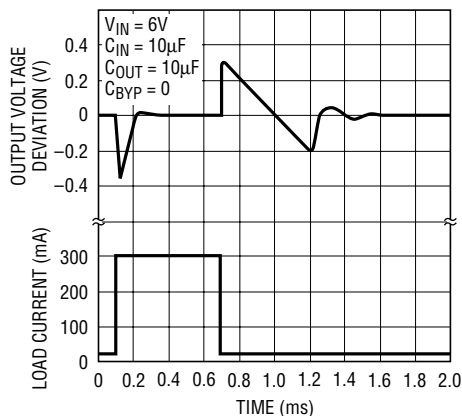

LT1962-5 Transient Response

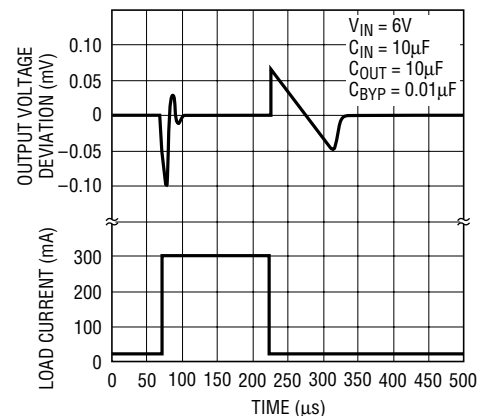

PIN FUNCTIONS

OUT (Pin 1): Output. The output supplies power to the load. A minimum output capacitor of $3.3\mu F$ is required to prevent oscillations. Larger output capacitors will be required for applications with large transient loads to limit peak voltage transients. See the Applications Information section for more information on output capacitance and reverse output characteristics.

SENSE (Pin 2): Sense. For fixed voltage versions of the LT1962 (LT1962-1.5/LT1962-1.8/LT1962-2.5/LT1962-3/LT1962-3.3/LT1962-5), the SENSE pin is the input to the error amplifier. Optimum regulation will be obtained at the point where the SENSE pin is connected to the OUT pin of the regulator. In critical applications, small voltage drops

are caused by the resistance (R_P) of PC traces between the regulator and the load. These may be eliminated by connecting the SENSE pin to the output at the load as shown in Figure 1 (Kelvin Sense Connection). Note that the voltage drop across the external PC traces will add to the dropout voltage of the regulator. The SENSE pin bias current is $10\mu A$ at the nominal rated output voltage. The SENSE pin can be pulled below ground (as in a dual supply system where the regulator load is returned to a negative supply) and still allow the device to start and operate.

ADJ (Pin 2): Adjust. For the adjustable LT1962, this is the input to the error amplifier. This pin is internally clamped to $\pm 7V$. It has a bias current of $30nA$ which flows into the

PIN FUNCTIONS

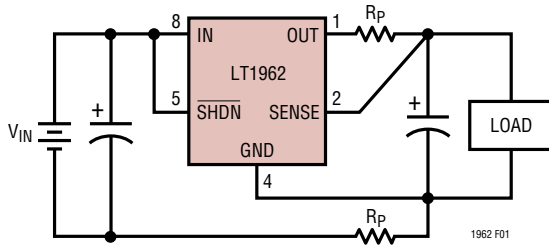

Figure 1. Kelvin Sense Connection

pin. The ADJ pin voltage is 1.22V referenced to ground and the output voltage range is 1.22V to 20V.

BYP (Pin 3): Bypass. The BYP pin is used to bypass the reference of the LT1962 to achieve low noise performance from the regulator. The BYP pin is clamped internally to $\pm 0.6V$ (one V_{BE}). A small capacitor from the output to this pin will bypass the reference to lower the output voltage noise. A maximum value of $0.01\mu F$ can be used for reducing output voltage noise to a typical $20\mu V_{RMS}$ over a 10Hz to 100kHz bandwidth. If not used, this pin must be left unconnected.

GND (Pin 4): Ground.

SHDN (Pin 5): Shutdown. The SHDN pin is used to put the LT1962 regulators into a low power shutdown state. The output will be off when the SHDN pin is pulled low. The

SHDN pin can be driven either by 5V logic or open-collector logic with a pull-up resistor. The pull-up resistor is required to supply the pull-up current of the open-collector gate, normally several microamperes, and the SHDN pin current, typically $1\mu A$. If unused, the SHDN pin must be connected to V_{IN} . The device will not function if the SHDN pin is not connected.

NC (Pins 6, 7): No Connect. These pins are not internally connected. For improved power handling capabilities, these pins can be connected to the PC board.

IN (Pin 8): Input. Power is supplied to the device through the IN pin. A bypass capacitor is required on this pin if the device is more than six inches away from the main input filter capacitor. In general, the output impedance of a battery rises with frequency, so it is advisable to include a bypass capacitor in battery-powered circuits. A bypass capacitor in the range of $1\mu F$ to $10\mu F$ is sufficient. The LT1962 regulators are designed to withstand reverse voltages on the IN pin with respect to ground and the OUT pin. In the case of a reverse input, which can happen if a battery is plugged in backwards, the device will act as if there is a diode in series with its input. There will be no reverse current flow into the regulator and no reverse voltage will appear at the load. The device will protect both itself and the load.

APPLICATIONS INFORMATION

The LT1962 series are 300mA low dropout regulators with micropower quiescent current and shutdown. The devices are capable of supplying 300mA at a dropout voltage of 300mV. Output voltage noise can be lowered to $20\mu V_{RMS}$ over a 10Hz to 100kHz bandwidth with the addition of a $0.01\mu F$ reference bypass capacitor. Additionally, the reference bypass capacitor will improve transient response of the regulator, lowering the settling time for transient load conditions. The low operating quiescent current ($30\mu A$) drops to less than $1\mu A$ in shutdown. In addition to the low quiescent current, the LT1962 regulators incorporate several protection features which make them ideal for use in battery-powered systems. The devices are protected against both reverse input and reverse output voltages. In battery backup applications where the output can be held

up by a backup battery when the input is pulled to ground, the LT1962-X acts like it has a diode in series with its output and prevents reverse current flow. Additionally, in dual supply applications where the regulator load is returned to a negative supply, the output can be pulled below ground by as much as 20V and still allow the device to start and operate.

Adjustable Operation

The adjustable version of the LT1962 has an output voltage range of 1.22V to 20V. The output voltage is set by the ratio of two external resistors as shown in Figure 2. The device servos the output to maintain the ADJ pin voltage at 1.22V referenced to ground. The current in R1 is then equal to $1.22V/R1$ and the current in R2 is the current in R1

APPLICATIONS INFORMATION

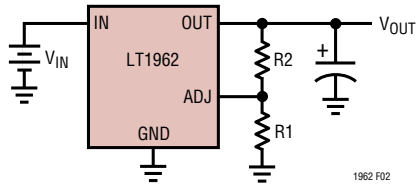

$$V_{OUT} = 1.22V \left(1 + \frac{R2}{R1} \right) + (I_{ADJ})(R2)$$

$$V_{ADJ} = 1.22V$$

$$I_{ADJ} = 30nA \text{ AT } 25^{\circ}C$$

$$\text{OUTPUT RANGE} = 1.22V \text{ TO } 20V$$

Figure 2. Adjustable Operation

plus the ADJ pin bias current. The ADJ pin bias current, 30nA at 25°C, flows through R2 into the ADJ pin. The output voltage can be calculated using the formula in Figure 2. The value of R1 should be no greater than 250k to minimize errors in the output voltage caused by the ADJ pin bias current. Note that in shutdown the output is turned off and the divider current will be zero.

The adjustable device is tested and specified with the ADJ pin tied to the OUT pin for an output voltage of 1.22V. Specifications for output voltages greater than 1.22V will be proportional to the ratio of the desired output voltage to 1.22V: $V_{OUT}/1.22V$. For example, load regulation for an output current change of 1mA to 300mA is –2mV typical at $V_{OUT} = 1.22V$. At $V_{OUT} = 12V$, load regulation is:

$$(12V/1.22V)(-2mV) = -19.7mV$$

Bypass Capacitance and Low Noise Performance

The LT1962 regulators may be used with the addition of a bypass capacitor from V_{OUT} to the BYP pin to lower output voltage noise. A good quality low leakage capacitor is recommended. This capacitor will bypass the reference of the regulator, providing a low frequency noise pole. The noise pole provided by this bypass capacitor will lower the output voltage noise to as low as $20\mu V_{RMS}$ with the addition of a 0.01μF bypass capacitor. Using a bypass capacitor has the added benefit of improving transient response. With no bypass capacitor and a 10μF output capacitor, a 10mA to 300mA load step will settle to within 1% of its final value in less than 100μs. With the addition of a 0.01μF bypass capacitor, the output will settle to within 1% for a 10mA to 300mA load step in less than 10μs, with total output voltage deviation of less than 2%

(see LT1962-5 Transient Response in the Typical Performance Characteristics). However, regulator start-up time is inversely proportional to the size of the bypass capacitor, slowing to 15ms with a 0.01μF bypass capacitor and 10μF output capacitor.

Output Capacitance and Transient Response

The LT1962 regulators are designed to be stable with a wide range of output capacitors. The ESR of the output capacitor affects stability, most notably with small capacitors. A minimum output capacitor of 3.3μF with an ESR of 3Ω or less is recommended to prevent oscillations. The LT1962-X is a micropower device and output transient response will be a function of output capacitance. Larger values of output capacitance decrease the peak deviations and provide improved transient response for larger load current changes. Bypass capacitors, used to decouple individual components powered by the LT1962, will increase the effective output capacitor value. With larger capacitors used to bypass the reference (for low noise operation), larger values of output capacitance are needed. For 100pF of bypass capacitance, 4.7μF of output capacitor is recommended. With a 1000pF bypass capacitor or larger, a 6.8μF output capacitor is recommended.

The shaded region of Figure 3 defines the range over which the LT1962 regulators are stable. The minimum ESR needed is defined by the amount of bypass capacitance used, while the maximum ESR is 3Ω.

Extra consideration must be given to the use of ceramic capacitors. Ceramic capacitors are manufactured with a variety of dielectrics, each with different behavior across

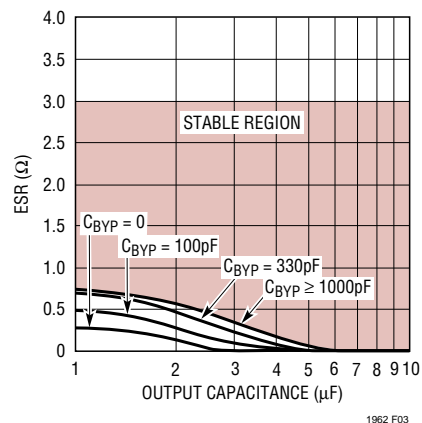

Figure 3. Stability

APPLICATIONS INFORMATION

temperature and applied voltage. The most common dielectrics used are Z5U, Y5V, X5R and X7R. The Z5U and Y5V dielectrics are good for providing high capacitance in a small package, but exhibit strong voltage and temperature coefficients as shown in Figures 4 and 5. When used with a 5V regulator, a 10 μ F Y5V capacitor can exhibit an effective value as low as 1 μ F to 2 μ F over the operating temperature range. The X5R and X7R dielectrics result in more stable characteristics and are more suitable for use as the output capacitor. The X7R type has better stability across temperature, while the X5R is less expensive and is available in higher values.

Voltage and temperature coefficients are not the only sources of problems. Some ceramic capacitors have a piezoelectric response. A piezoelectric device generates voltage across its terminals due to mechanical stress, similar to the way a piezoelectric accelerometer or micro-

phone works. For a ceramic capacitor the stress can be induced by vibrations in the system or thermal transients. The resulting voltages produced can cause appreciable amounts of noise, especially when a ceramic capacitor is used for noise bypassing. A ceramic capacitor produced Figure 6's trace in response to light tapping from a pencil. Similar vibration induced behavior can masquerade as increased output voltage noise.

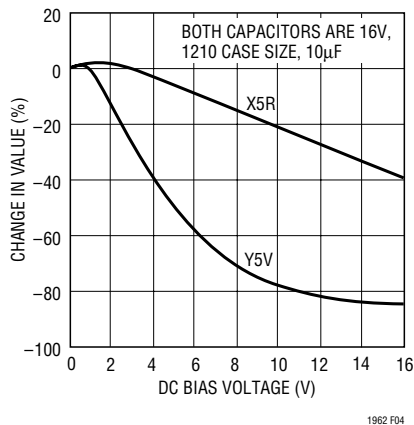

Figure 4. Ceramic Capacitor DC Bias Characteristics

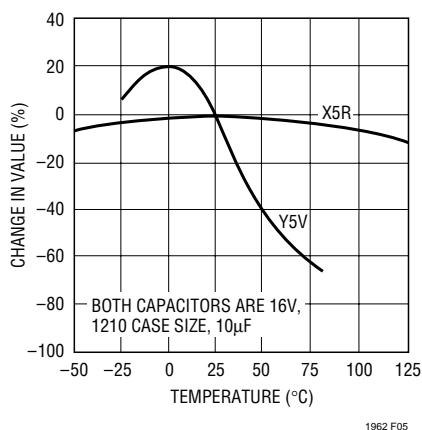

Figure 5. Ceramic Capacitor Temperature Characteristics

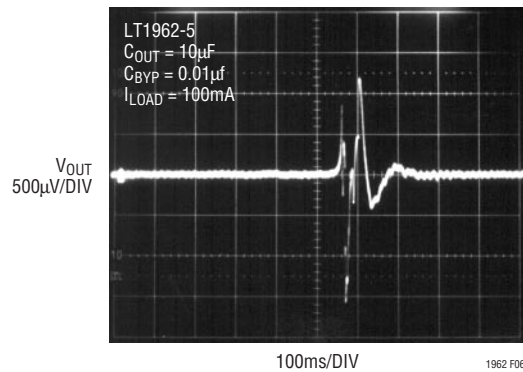

Figure 6. Noise Resulting from Tapping on a Ceramic Capacitor

Thermal Considerations

The power handling capability of the device will be limited by the maximum rated junction temperature (125°C). The power dissipated by the device will be made up of two components:

1. Output current multiplied by the input/output voltage differential: $(I_{OUT})(V_{IN} - V_{OUT})$, and
2. GND pin current multiplied by the input voltage: $(I_{GND})(V_{IN})$.

The GND pin current can be found by examining the GND Pin Current curves in the Typical Performance Characteristics. Power dissipation will be equal to the sum of the two components listed above.

The LT1962 series regulators have internal thermal limiting designed to protect the device during overload conditions. For continuous normal conditions, the maximum junction temperature rating of 125°C must not be exceeded. It is important to give careful consideration to all sources of thermal resistance from junction to ambient. Additional heat sources mounted nearby must also be considered.

APPLICATIONS INFORMATION

For surface mount devices, heat sinking is accomplished by using the heat spreading capabilities of the PC board and its copper traces. Copper board stiffeners and plated through-holes can also be used to spread the heat generated by power devices.

The following table lists thermal resistance for several different board sizes and copper areas. All measurements were taken in still air on 1/16" FR-4 board with one ounce copper.

Table 1. Measured Thermal Resistance

COPPER AREA		BOARD AREA	THERMAL RESISTANCE (JUNCTION-TO-AMBIENT)
TOPSIDE*	BACKSIDE		
2500mm ²	2500mm ²	2500mm ²	110°C/W
1000mm ²	2500mm ²	2500mm ²	115°C/W
225mm ²	2500mm ²	2500mm ²	120°C/W
100mm ²	2500mm ²	2500mm ²	130°C/W
50mm ²	2500mm ²	2500mm ²	140°C/W

*Device is mounted on topside.

Calculating Junction Temperature

Example: Given an output voltage of 3.3V, an input voltage range of 4V to 6V, an output current range of 0mA to 100mA and a maximum ambient temperature of 50°C, what will the maximum junction temperature be?

The power dissipated by the device will be equal to:

$$I_{OUT(MAX)}(V_{IN(MAX)} - V_{OUT}) + I_{GND}(V_{IN(MAX)})$$

where,

$$I_{OUT(MAX)} = 100\text{mA}$$

$$V_{IN(MAX)} = 6\text{V}$$

$$I_{GND} \text{ at } (I_{OUT} = 100\text{mA}, V_{IN} = 6\text{V}) = 2\text{mA}$$

So,

$$P = 100\text{mA}(6\text{V} - 3.3\text{V}) + 2\text{mA}(6\text{V}) = 0.28\text{W}$$

The thermal resistance will be in the range of 110°C/W to 140°C/W depending on the copper area. So the junction temperature rise above ambient will be approximately equal to:

$$0.28\text{W}(125^\circ\text{C/W}) = 35.3^\circ\text{C}$$

The maximum junction temperature will then be equal to the maximum junction temperature rise above ambient plus the maximum ambient temperature or:

$$T_{JMAX} = 50^\circ\text{C} + 35.3^\circ\text{C} = 85.3^\circ\text{C}$$

Protection Features

The LT1962 regulators incorporate several protection features which make them ideal for use in battery-powered circuits. In addition to the normal protection features associated with monolithic regulators, such as current limiting and thermal limiting, the devices are protected against reverse input voltages, reverse output voltages and reverse voltages from output to input.

Current limit protection and thermal overload protection are intended to protect the device against current overload conditions at the output of the device. For normal operation, the junction temperature should not exceed 125°C.

The input of the device will withstand reverse voltages of 20V. Current flow into the device will be limited to less than 1mA (typically less than 100µA) and no negative voltage will appear at the output. The device will protect both itself and the load. This provides protection against batteries which can be plugged in backward.

The output of the LT1962 can be pulled below ground without damaging the device. If the input is left open circuit or grounded, the output can be pulled below ground by 20V. For fixed voltage versions, the output will act like a large resistor, typically 500k or higher, limiting current flow to less than 40µA. For adjustable versions, the output will act like an open circuit; no current will flow out of the pin. If the input is powered by a voltage source, the output will source the short-circuit current of the device and will protect itself by thermal limiting. In this case, grounding the SHDN pin will turn off the device and stop the output from sourcing the short-circuit current.

The ADJ pin of the adjustable device can be pulled above or below ground by as much as 7V without damaging the device. If the input is left open circuit or grounded, the ADJ pin will act like an open circuit when pulled below ground and like a large resistor (typically 100k) in series with a diode when pulled above ground.

In situations where the ADJ pin is connected to a resistor divider that would pull the ADJ pin above its 7V clamp voltage if the output is pulled high, the ADJ pin input current must be limited to less than 5mA. For example, a resistor divider is used to provide a regulated 1.5V output

APPLICATIONS INFORMATION

from the 1.22V reference when the output is forced to 20V. The top resistor of the resistor divider must be chosen to limit the current into the ADJ pin to less than 5mA when the ADJ pin is at 7V. The 13V difference between OUT and ADJ pin divided by the 5mA maximum current into the ADJ pin yields a minimum top resistor value of 2.6k.

In circuits where a backup battery is required, several different input/output conditions can occur. The output voltage may be held up while the input is either pulled to ground, pulled to some intermediate voltage or is left open circuit. Current flow back into the output will follow the curve shown in Figure 7.

When the IN pin of the LT1962 is forced below the OUT pin or the OUT pin is pulled above the IN pin, input current will typically drop to less than 2µA. This can happen if the input of the device is connected to a discharged (low voltage) battery and the output is held up by either a backup battery

or a second regulator circuit. The state of the SHDN pin will have no effect on the reverse output current when the output is pulled above the input.

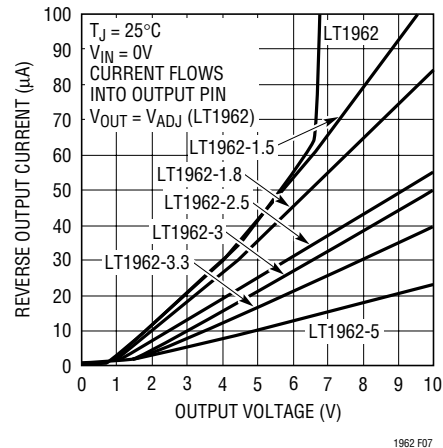
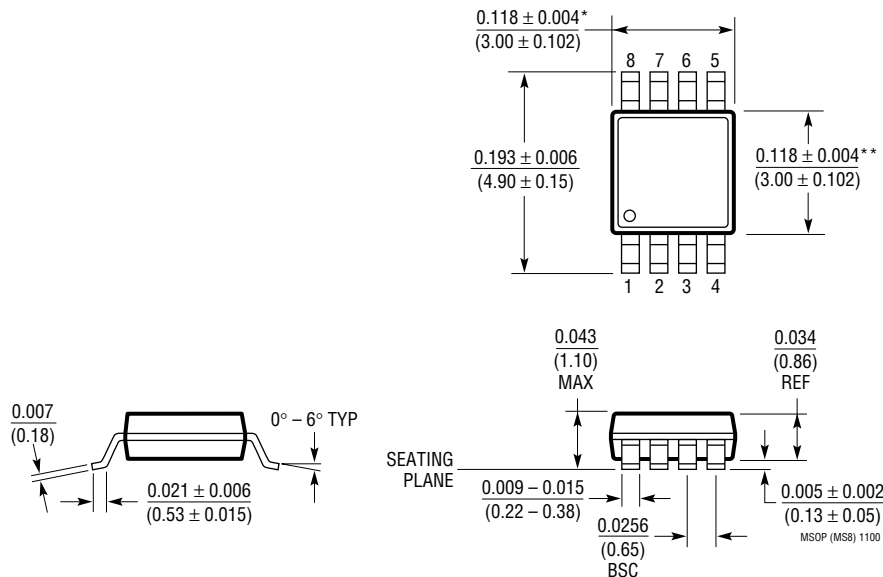

Figure 7. Reverse Output Current

PACKAGE DESCRIPTION

Dimensions in inches (millimeters) unless otherwise noted.

MS8 Package 8-Lead Plastic MSOP (LTC DWG # 05-08-1660)



* DIMENSION DOES NOT INCLUDE MOLD FLASH, PROTRUSIONS OR GATE BURRS. MOLD FLASH, PROTRUSIONS OR GATE BURRS SHALL NOT EXCEED 0.006" (0.152mm) PER SIDE

** DIMENSION DOES NOT INCLUDE INTERLEAD FLASH OR PROTRUSIONS. INTERLEAD FLASH OR PROTRUSIONS SHALL NOT EXCEED 0.006" (0.152mm) PER SIDE

TYPICAL APPLICATIONS

Adjustable Current Source

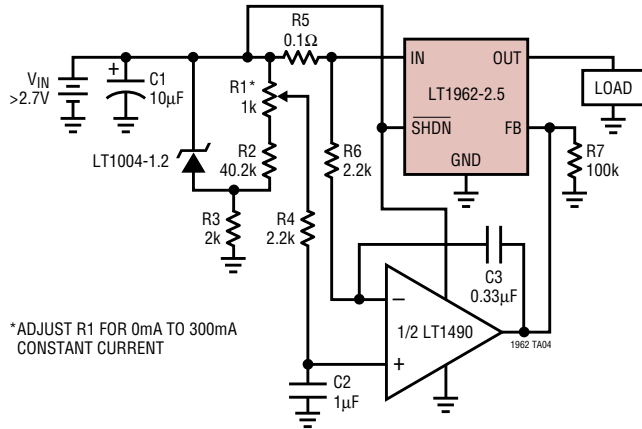

Paralleling of Regulators for Higher Output Current

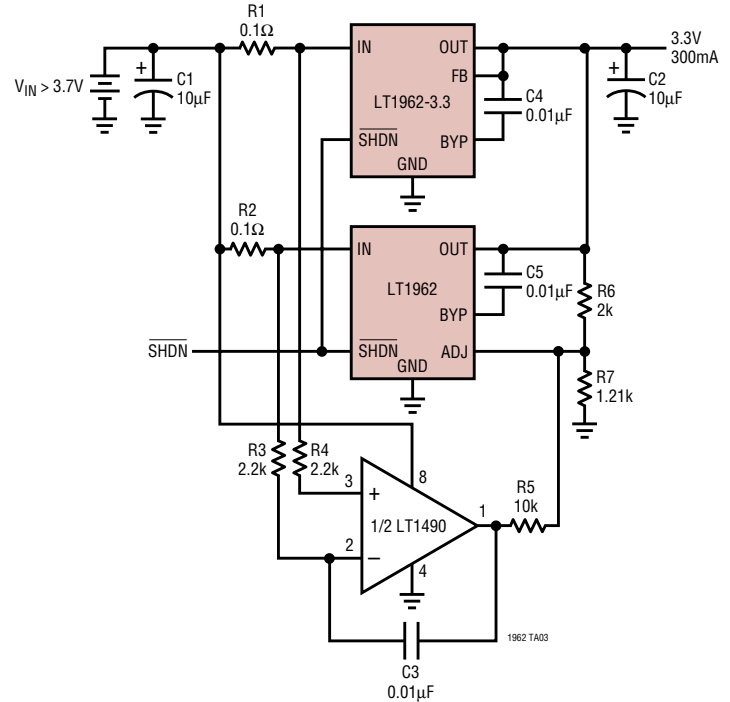

RELATED PARTS

PART NUMBER	DESCRIPTION	COMMENTS
LT1120	125mA Low Dropout Regulator with 20 μ A I _Q	Includes 2.5V Reference and Comparator
LT1121	150mA Micropower Low Dropout Regulator	30 μ A I _Q , SOT-223 Package
LT1129	700mA Micropower Low Dropout Regulator	50 μ A Quiescent Current
LT1175	500mA Negative Low Dropout Micropower Regulator	45 μ A I _Q , 0.26V Dropout Voltage, SOT-223 Package
LT1521	300mA Low Dropout Micropower Regulator with Shutdown	15 μ A I _Q , Reverse Battery Protection
LT1529	3A Low Dropout Regulator with 50 μ A I _Q	500mV Dropout Voltage
LTC1627	High Efficiency Synchronous Step-Down Switching Regulator	Burst Mode™ Operation, Monolithic, 100% Duty Cycle
LT1761	100mA, Low Noise, Low Dropout Micropower Regulator in SOT-23	20 μ A Quiescent Current, 20 μ V _{RMS} Noise
LT1762	150mA, Low Noise, LDO Micropower Regulator	25 μ A Quiescent Current, 20 μ V _{RMS} Noise
LT1763	500mA, Low Noise, LDO Micropower Regulator	30 μ A Quiescent Current, 20 μ V _{RMS} Noise
LT1764	3A, Fast Transient Response Low Dropout Regulator	340mV Dropout Voltage, 40 μ V _{RMS} Noise
LT1772	Constant Frequency Current Mode Step-Down DC/DC Controller	Up to 94% Efficiency, SOT-23 Package, 100% Duty Cycle
LT1963	1.5A, Fast Transient Response Low Dropout Regulator	S0-8, SOT-223 Packages

Burst Mode is a trademark of Linear Technology Corporation.