



Thin-Film Cascadable Amplifier 20 to 150 MHz

Technical Data

UTO/UTC 102 Series

Features

- **Frequency Range: 20 to 150 MHz**
- **High Gain: 24.5 dB (Typ)**
- **Low Noise: 2.7 dB (Typ)**
- **High Power: 19.5 dBm (Typ)**
- **Temperature Compensated**

Applications

- **Low Frequency IF Stages**
- **Medical Instruments: Ultra-Sound, Magnetic Resonance**

Description

The 102 Series is a single-stage, high-gain silicon bipolar amplifier that incorporates thin-film technology. A low noise figure and high efficiency are the result of an output transformer coupling design. Resistive feedback and active bias provide temperature compensation and increased immunity to bias voltage variations. Blocking capacitors couple the RF through the amplifier while a low VSWR is maintained through inductive tuning. The 102 Series is available in either the T0-8 hermetic package or the connected TC-1A package.

Pin Configuration UTO—T0-8T

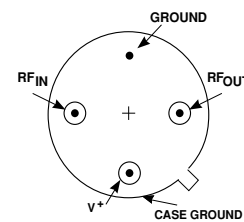

UTC—TC-1A

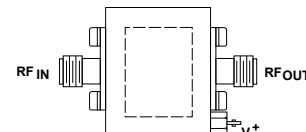

Schematic

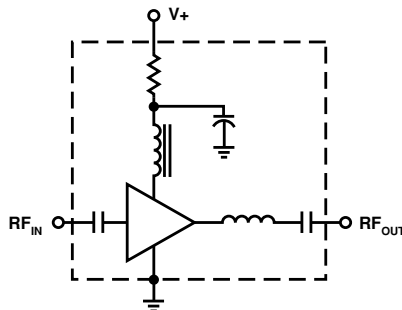

Maximum Ratings

Parameter	Maximum
DC Voltage	17 Volts
Continuous RF Input Power	+13 dBm
Operating Case Temperature	-55 to +125°C
Storage Temperature	-62 to +150°C
"R" Series Burn-In Temperature	+125°C

Thermal Characteristics¹

θ_{JC}	87°C/W
Active Transistor Power Dissipation	266 mW
Junction Temperature Above Case Temperature	23°C
MTBF (MIL-HDBK-217E, A_{UF} @ 90°C)	564,100 Hrs.

Weight: (typical) UTO — 2.1 grams; UTC — 21.5 grams

Electrical Specifications

(Measured in 50 Ω system @ +15 VDC nominal)

Symbol	Characteristic	Typical $T_C = 25^\circ\text{C}$	Guaranteed Specifications		Unit
			$T_C = 0$ to 50°C	$T_C = -55$ to $+85^\circ\text{C}$	
BW	Frequency Range	20-150	20-150	20-150	MHz
GP	Small Signal Gain (Min.)	24.5	23.5	22.5	dB
—	Gain Flatness (Max.)	± 0.3	± 1.0	± 1.0	dB
NF	Noise Figure (Max.)	2.7	3.2	3.5	dB
P_{1dB}	Power Output @ +1 dB Comp. (Min.)	+19.5	+18.0	+17.5	dBm
VSWR	Input VSWR (Max.)	1.5:1	2.0:1	2.0:1	—
VSWR	Output VSWR (Max.)	1.5:1	2.0:1	2.0:1	—
IP_3	Two Tone 3rd Order Intercept Point	+32.0	—	—	dBm
IP_2	Two Tone 2nd Order Intercept Point	+43.0	—	—	dBm
HP_2	One Tone 2nd Harmonic Intercept Pt.	+50.0	—	—	dBm
I_D	DC Current	31	—	—	mA

Typical Performance Over Temperature (@ +15 VDC unless otherwise noted)

Key: $+25^\circ\text{C}$ —
 $+85^\circ\text{C}$ - -
 -55°C —

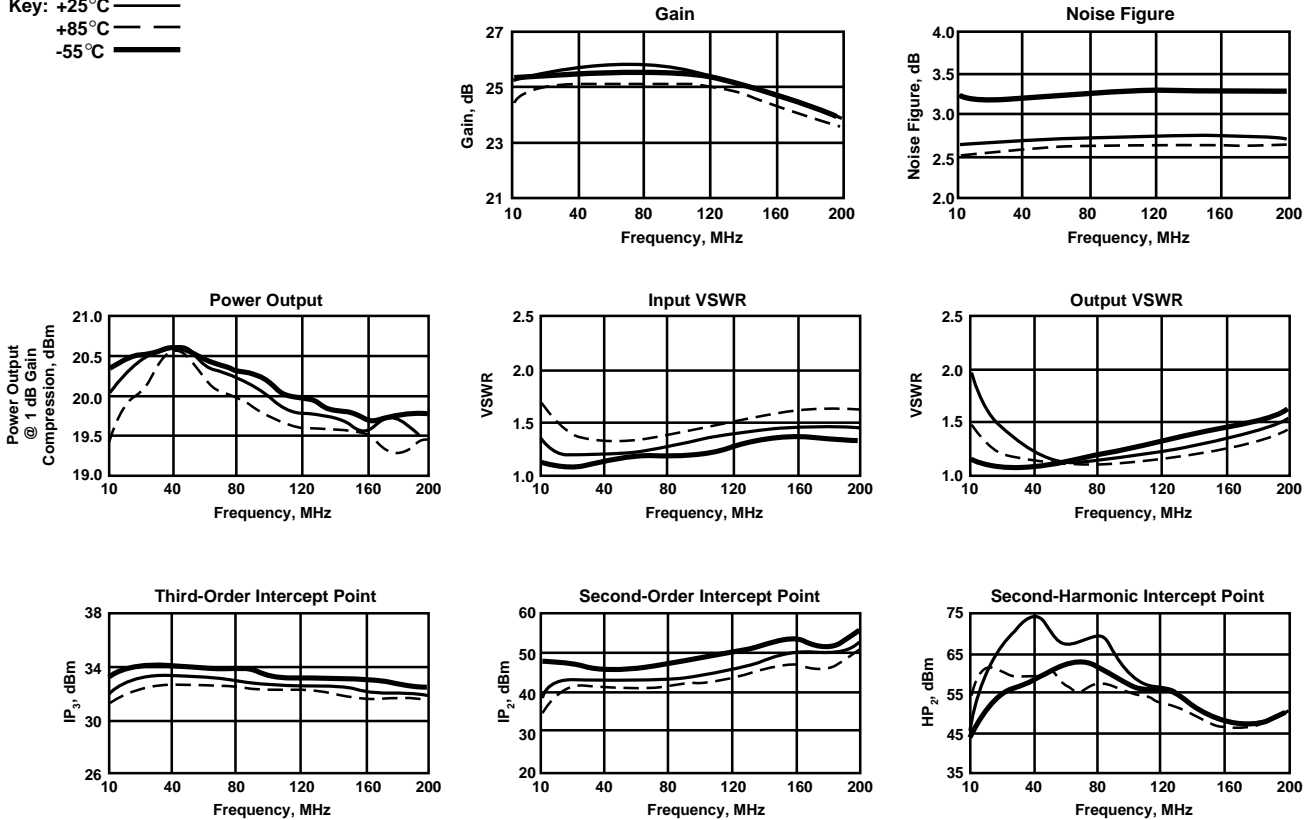

Automatic Network Analyzer Measurements (Typical production unit @ +25°C ambient)

S-Parameters
Bias = 15 Volts, Current = 30.8 mA

Freq. GHz	S ₁₁		S ₂₁		S ₁₁		S ₁₁		GPDEL (ns)	PHASE DEV (deg)
	Mag	Ang	dB	Ang	dB	Ang	Mag	Ang		
10	.18	-81.6	24.9	-166.0	-29.6	17.9	.22	117.60	3.53	
20	.09	-46.3	25.0	-178.6	-29.3	9.7	.11	108.39	3.53	1.92
30	.07	-23.4	25.1	174.7	-29.3	7.0	.07	108.92	1.87	-.10
40	.07	-3.7	25.1	169.4	-29.2	5.7	.04	108.26	1.47	-.67
50	.08	7.9	25.1	164.6	-29.3	4.9	.03	114.61	1.33	-.76
60	.09	13.0	25.1	160.0	-29.2	4.9	.01	139.73	1.28	-.63
70	.10	14.4	25.2	155.5	-29.2	4.8	.01	-149.97	1.25	-.43
80	.12	14.0	25.2	151.0	-29.2	5.0	.02	-122.85	1.25	-.21
90	.13	11.7	25.2	146.5	-29.2	4.9	.04	-117.87	1.26	-.06
100	.14	8.5	25.1	141.9	-29.2	5.7	.05	-117.48	1.27	.09
110	.16	4.7	25.1	137.3	-29.2	5.9	.06	-119.65	1.29	.15
120	.17	.3	25.0	132.7	-29.1	6.6	.08	-122.64	1.29	.21
130	.17	-4.3	25.0	127.9	-29.1	7.0	.09	-126.49	1.31	.20
140	.18	-9.3	24.8	123.2	-29.0	7.5	.11	-130.72	1.32	.16
150	.19	-14.5	24.7	118.5	-28.9	8.0	.12	-135.32	1.31	.14
160	.19	-20.0	24.5	113.8	-28.7	8.8	.14	-140.04	1.31	
170	.19	-25.5	24.3	109.1	-28.6	9.4	.16	-144.87	1.29	
180	.20	-30.8	24.1	104.5	-28.4	9.6	.17	-149.88	1.28	
190	.19	-36.5	23.9	100.0	-28.3	10.1	.18	-154.91	1.25	
200	.19	-41.9	23.6	95.6	-28.1	10.4	.20	-159.84	1.22	
210	.19	-47.5	23.3	91.3	-27.9	10.4	.21	-164.78	1.18	
220	.19	-52.8	23.0	87.2	-27.7	10.3	.22	-169.65	1.15	
230	.18	-58.4	22.7	83.2	-27.5	10.2	.23	-174.41	1.12	
240	.18	-63.8	22.4	79.3	-27.3	10.0	.25	-179.07	1.07	
250	.17	-69.0	22.0	75.6	-27.1	9.5	.26	176.47	1.03	
260	.16	-74.6	21.7	72.0	-26.9	9.3	.27	172.04	1.00	
270	.16	-79.9	21.3	68.6	-26.7	8.3	.27	167.70	.95	
280	.15	-85.2	21.0	65.2	-26.5	7.8	.28	163.57	.92	
290	.14	-90.8	20.6	62.0	-26.4	7.1	.29	159.51	.90	
300	.14	-96.5	20.3	58.9	-26.2	6.3	.30	155.49	.87	
310	.13	-102.1	19.9	55.9	-28.0	5.5	.31	151.64	.83	
320	.12	-107.8	19.6	53.0	-25.9	4.5	.31	147.88	.81	
330	.12	-113.8	19.2	50.2	-25.7	3.6	.32	144.17	.78	
340	.11	-120.1	18.9	47.5	-25.6	2.5	.33	140.60	.77	
350	.11	-126.3	18.5	44.8	-25.5	1.7	.33	137.08	.73	
360	.10	-132.7	18.2	42.2	-25.3	.5	.34	133.67	.72	
370	.10	-139.6	17.8	39.7	-25.3	-.5	.35	130.25	.70	
380	.09	-146.4	17.5	37.3	-25.2	-1.6	.35	126.96	.69	
390	.09	-153.3	17.1	34.9	-25.1	-2.7	.36	123.74	.66	
400	.09	-160.5	16.8	32.6	-24.9	-3.9	.36	120.56	.64	
410	.09	-167.6	16.5	30.2	-24.8	4.8	.37	117.41	.65	
420	.09	-174.6	16.1	28.0	-24.8	-6.1	.38	114.37	.62	
430	.09	178.3	15.8	25.8	-24.7	-7.1	.38	111.36	.61	
440	.09	170.9	15.5	23.6	-24.6	-8.5	.39	108.40	.60	
450	.09	164.2	15.2	21.5	-24.5	-9.5	.39	105.49	.53	
460	.09	158.0	14.9	19.5	-24.5	-10.8	.40	102.64	.58	
470	.09	151.3	14.6	17.4	-24.5	-12.1	.40	99.78	.58	
480	.09	145.8	14.3	15.4	-24.4	-13.4	.41	97.02	.56	
490	.10	140.3	14.0	13.4	-24.3	-14.6	.41	94.29	.55	
500	.10	134.8	13.7	11.4	-24.3	-15.7	.42	91.58	.55	

Product Options

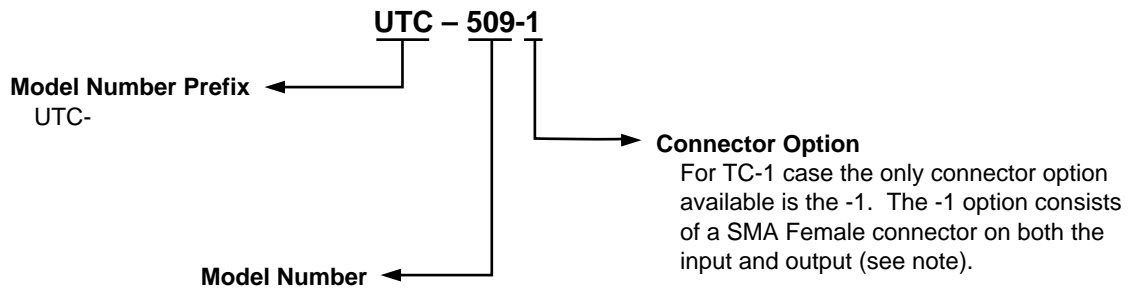
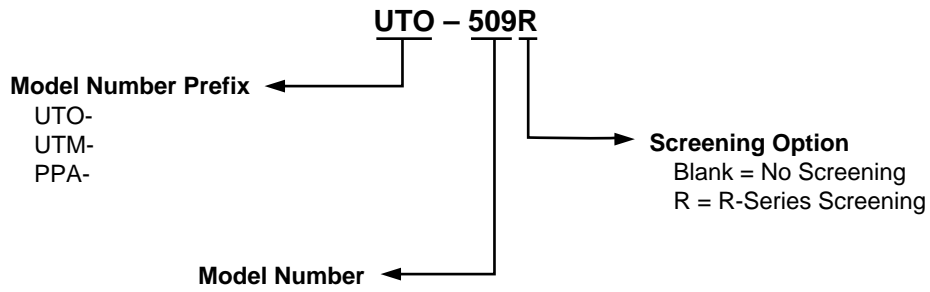

Note: R-Series screening is not available in the TC-1 case as the case is non-hermetic.

**Case Drawings
TO-8T**

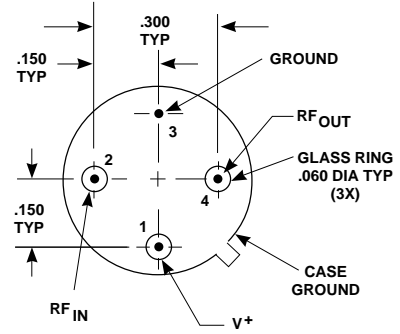
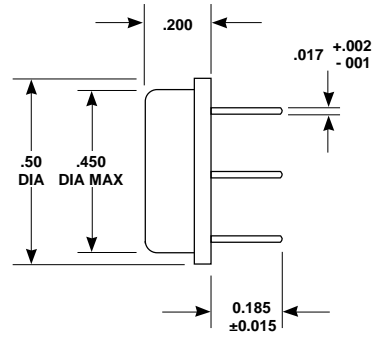
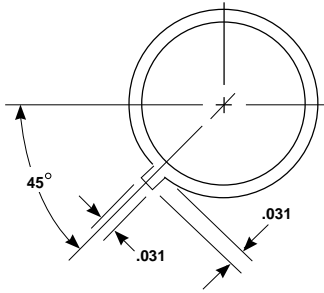

APPROXIMATE WEIGHT 2.1 GRAMS

- NOTES (UNLESS OTHERWISE SPECIFIED):**
 1. DIMENSIONS ARE SPECIFIED IN INCHES
 2. TOLERANCES: xx ± .02
 xxx ± .010

TC-1A

