



# INSTALLATION INSTRUCTIONS

## Street Fire CDI PN 5520

**ONLINE PRODUCT REGISTRATION:** Register your MSD product online. Registering your product will help if there is ever a warranty issue with your product and helps the MSD R&D team create new products that you ask for! Go to [www.msperformance.com/registration](http://www.msperformance.com/registration).

### Parts Included:

1 - Ignition	1 - 18" Ground Wire	4 - Mounting Screws
1 - Harness, PN 8860	1 - 100V/1A Diode	

**WARNING:** During installation, disconnect the battery cables. When disconnecting the battery always remove the Negative cable first and install it last.

**Note:** Solid Core spark plug wires **cannot** be used with the Street Fire Ignition.

**Note:** The Street Fire Ignition **cannot** be used with distributorless ignition systems (DIS).

## GENERAL INFORMATION

### BATTERY

The Street Fire Ignition Control will operate on any negative ground, 12 volt electrical system with a distributor. It can be used with 16 volt batteries and can withstand a momentary 24 volts in case of jump starts. The Ignitions will deliver full voltage with a supply of 9 - 18 volts and will operate with a supply voltage as low as 7 volts.

### COILS

The Street Fire Ignition can be used with most stock coils and aftermarket coils designed to replace the stock coils. If you have any questions concerning coils, contact our Customer Service Department at (915) 855-7123.

### TACHOMETERS

The Street Fire Ignition features a Tach Output wire that provides a trigger signal for tachometers, a shift light or other add-on rpm activated devices. The Tach Output produces a 12 volt square wave signal with a 24% duty cycle.

Some vehicles with factory tachometers may require a Tach Adapter to operate with the ignition. For more information on Tachometers and MSD Tach Adapters, see the Tachometer Section on page 9.

If your GM vehicle has an inline filter it may cause the tach to drop to zero on acceleration. If this occurs, bypass the filter.

### FOREIGN VEHICLES

Due to the fuel injection systems, some foreign vehicles may require a special Tach/Fuel Injection Adapter with a Street Fire ignition. See page 9 for wiring and Tach Adapter information.

**Note:** Vehicles originally equipped with a CD ignition control **cannot** use the Street Fire Ignition.

### SPARK PLUGS AND WIRES

Spark plug wires are very important to the operation of your ignition system. A good quality, helically wound wire and proper routing are required to get the best performance from your ignition, such as the Street Fire Wire.

**Note:** Solid Core spark plug wires cannot be used with the Street Fire Ignition.

**Spark Plugs:** Choosing the correct spark plug design and heat range is important when trying to get the best performance possible. It is recommended to follow the engine builder or manufacturer's specification for spark plugs. With that, you can then experiment with the plug gap to obtain the best performance. The gap of the plugs can be opened in 0.005" increments, then tested until the best performance is obtained.

## MISCELLANEOUS INFORMATION

**Sealing:** Do not attempt to seal the ignition. All of the circuits of the Street Fire ignition receive a thick conformal coating of Humi-Seal. Rubber plugs are supplied to protect the rpm dials.

**Welding:** If you are welding on your vehicle, to avoid the chance of damage, always disconnect both Heavy Power cables of the ignition (You should also disconnect the tach ground wire).

## MOUNTING

The Street Fire Ignition can be mounted in most positions, except directly upside down (if upside down, moisture or water cannot escape). It can be mounted in the engine compartment as long as it is away from direct engine heat sources. It is not recommended to mount the unit in an enclosed area such as the glove box.

When you find a suitable location to mount the unit, make sure the wires of the ignition reach their connections. Hold the Ignition in place and mark the location of the mounting holes. Use an 1/8" drill bit to drill the holes. Use the supplied self tapping screws to mount the box.

## CYLINDER SELECT

The Rev Limiter that is built into the ignition is programmed for operation on a 8-cylinder engine. If you are installing one of these units on a 4 or 6-cylinder even-fire engine, the cylinder count must be selected. This is easily achieved through the cylinder select wire loops on the side of the ignition. To program the unit cut the loops as shown in Figure 1.

## LED

There is a diagnostic LED next to the rpm dials. The LED will blink with each trigger signal. It will appear On when the engine is running. If the input voltage drops below 9 volts it will flash at idle speed. For more codes, see page 10.

## WIRING

**Wire Length:** All of the wires of the ignition may be shortened as long as quality connectors are used or soldered in place. To lengthen the wires, use one size bigger gauge wire (10 gauge for the power leads and 16 gauge for the other wires) with the proper connections.

**Grounds:** A poor ground connection can cause many frustrating problems. When a wire is specified to go to ground, it should be connected to the battery negative terminal, engine block or chassis. There should always be a ground strap between the engine and the chassis. Always securely connect the ground wire to a clean, paint free metal surface.

## WIRE FUNCTIONS

<b>POWER LEADS</b>	These are the two heavy gauge wires (14 gauge) and are responsible for getting direct battery voltage to the Ignition.
<b>HEAVY RED</b>	This wire connects directly to the battery positive (+) terminal or to a positive battery junction or the positive side of the starter solenoid. <b>Note:</b> Never connect to the alternator.
<b>HEAVY BLACK</b>	This wire connects to a good ground, either at the battery negative (-) terminal or to the engine.
<b>RED</b>	Connects to a switched 12 volt source. Such as the ignition key or switch.
<b>ORANGE</b>	Connects to the positive (+) terminal of the coil. <b>This is the only wire that makes electrical contact with the coil positive terminal.</b>
<b>BLACK</b>	Connects to the negative (-) terminal of the coil. <b>This is the only wire that makes electrical contact with the coil negative terminal.</b>
<b>GRAY</b>	Tach output wire. Connect to the tachometer or other rpm device.
<b>TRIGGER WIRES</b>	There are two circuits that can be used to trigger the Street Fire Ignition; a Points circuit (White wire) and a Magnetic Pickup circuit (Violet and Green wires). The two circuits will <b>never</b> be used together.
<b>WHITE</b>	This wire is used to connect to the points or electronic ignition amplifier output .
<b>VIOLET AND GREEN (Magnetic Pickup Connector)</b>	These wires are routed together in one harness to form the Magnetic Pickup connector. The connector plugs directly into an MSD Distributor. It will also connect to factory magnetic pickups or other aftermarket pickups. The Violet wire is positive (+) and the Green is negative (-). <b>When these wires are used, the White wire is not.</b>

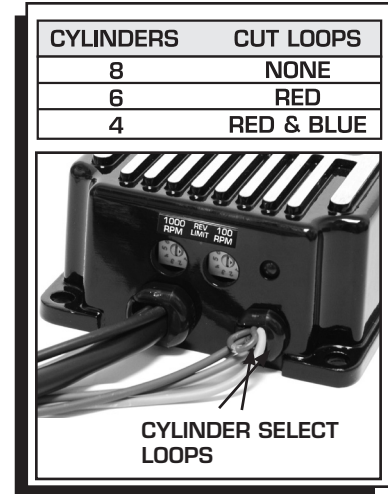

**Figure 1 Selecting the number of Cylinders.**

The chart in Figure 2 shows the polarity of other common magnetic pickups.

**Ballast Resistor:** If your vehicle has a ballast resistor in line with the coil wiring, it is recommended to bypass it.

**ROUTING WIRES**

The Street Fire wires should be routed away from direct heat sources such as exhaust manifolds and headers and any sharp edges. The trigger wires should be routed separate from the other wires and spark plug wires. It is best if they are routed along a ground plane such as the block or firewall which creates an electrical shield. The magnetic pickup wires should always be routed separately and should be twisted together to help reduce extraneous interference.

Common Mag Pickup Wires		
	Colors	
	Mag+	Mag-
MSD Distributor	Org/Blk	Vio/Blk
MSD Crank Trigger	Violet	Green
Ford	Orange	Violet
Accel 46/48000 Series	Org/Blk	Vio/Blk
Accel 51/61000 Series	Red	Black
Chrysler	Org/Wht	Black
Mallory	Org/Blk	Vio/Blk
Street Fire CDI	Violet	Green

Figure 2 Common Mag Pickup Wires.

**WARNING:** The Street Fire CDI is a capacitive discharge ignition. High voltage is present at the coil primary terminals. Do not touch the coil or connect test equipment to the terminals.

**REV LIMITER**

The Street Fire Ignition features an adjustable rev limiter. This feature will protect your engine from overrev damage in the event of driveline failure or a missed gear. The rev limit is adjustable from 2,000 - 9,900 rpm in 100 rpm increments (Figure 3).

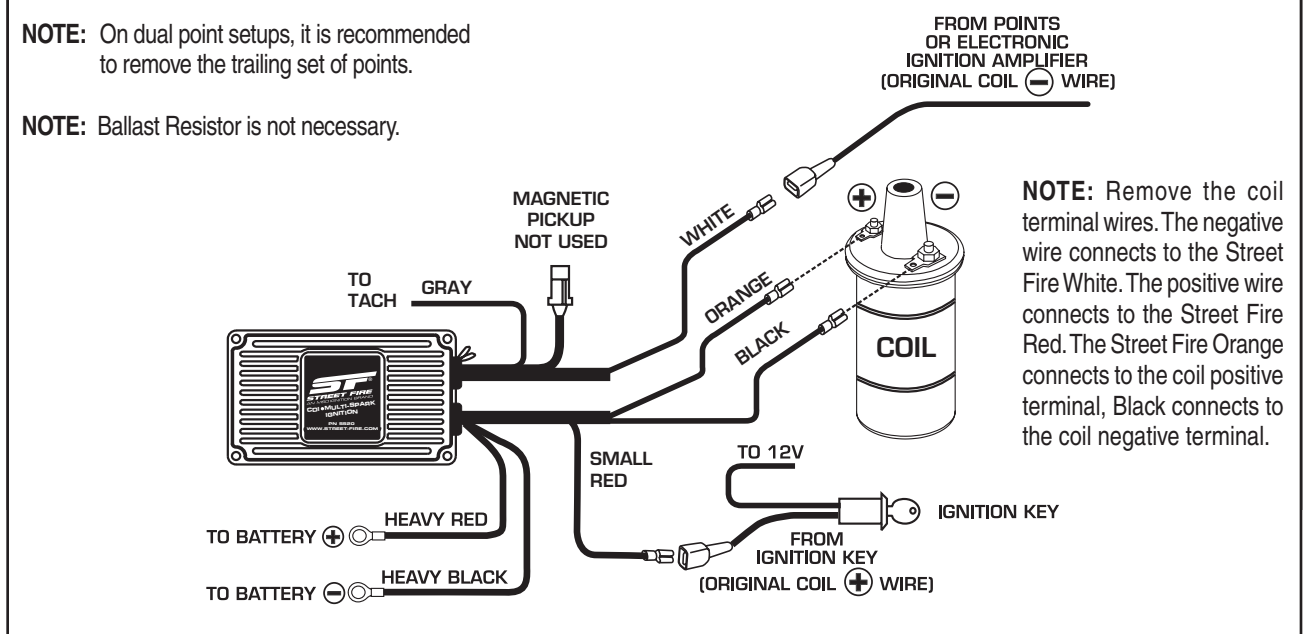

Figure 3 Adjusting the Rev Limiter.

**PRESTART CHECK LIST**

- The only wires connected to the coil terminals are the Street Fire Orange to coil positive and Black to coil negative.
- The small Red wire of the CDI is connected to a switched 12 volt source.
- If running a 4 or 6-cylinder engine the cylinder select must be modified.
- The power leads are connected directly to the battery positive and negative terminals.
- The battery is connected and fully charged if not using an alternator.
- The engine is equipped with at least one ground strap to the chassis.

**STREET FIRE SYSTEMS Installing to Points/Amplifier Style Ignition.**



**MSD SYSTEMS Installing to an MSD Distributor.**

NOTE: SEE FIGURE 2 FOR COMMON MAGNETIC PICKUPS.

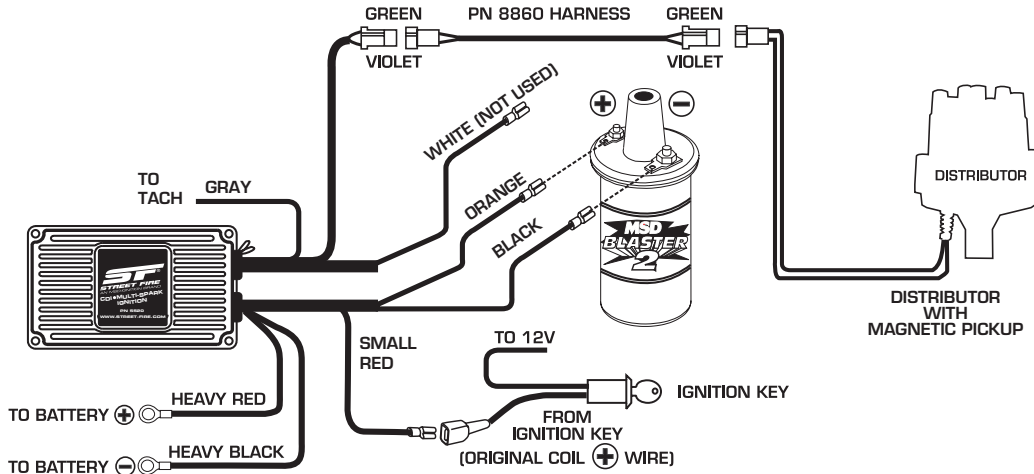

**GM IGNITIONS Wiring a Dual Connector Coil.**

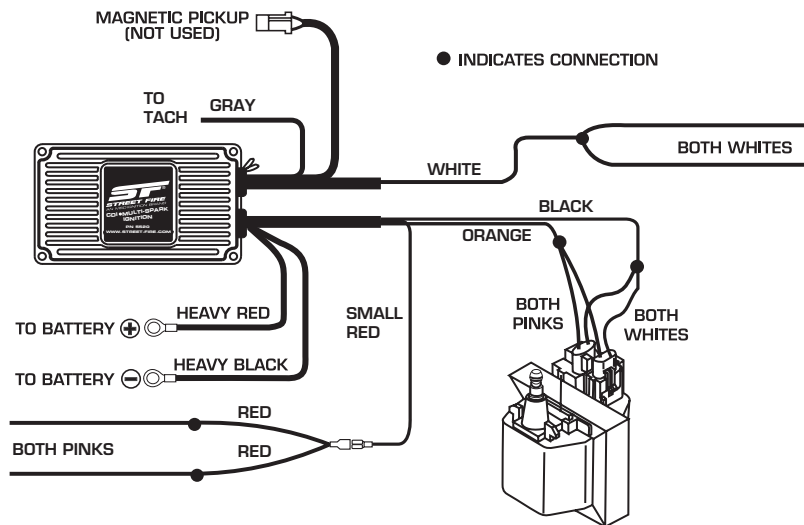

NOTE: For a direct plug-in, use MSD Harness PN 8876.

NOTE: Cut and splice the two Pink wires (coil positive) together and connect to Orange wire of the ignition. Cut and splice the two White wires (coil negative) together and connect to the White of the ignition. If the vehicle is not equipped with a factory tach, there will only be one White wire.

**GM IGNITIONS Wiring with an MSD Wiring Harness.**

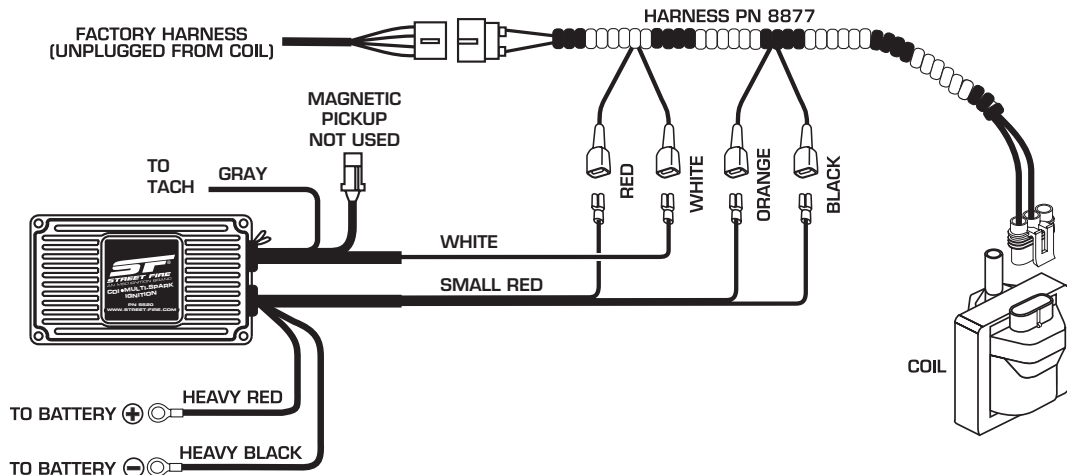

**GM IGNITIONS GM Large Cap HEI Distributors**

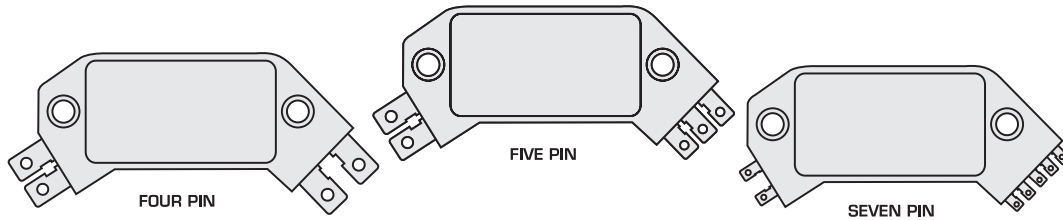

There are three different large cap HEI distributors. To identify which of the following diagrams fit your specific application, remove the distributor cap and rotor and locate the ignition module at the base of the distributor. Count the number of terminals on both ends of the module and follow the corresponding diagram. GM used 4, 5 and 7-pin modules in these distributors.

**NOTE:** Some 5-pin models may experience a hesitation or stall on deceleration. If this occurs, contact MSD Tech Line for the required bolt-in diode to correct the problem. MSD Tech Line (915) 855-7123.

**GM IGNITIONS Wiring an HEI 4-pin Module (Magnetic Pickup Trigger).**

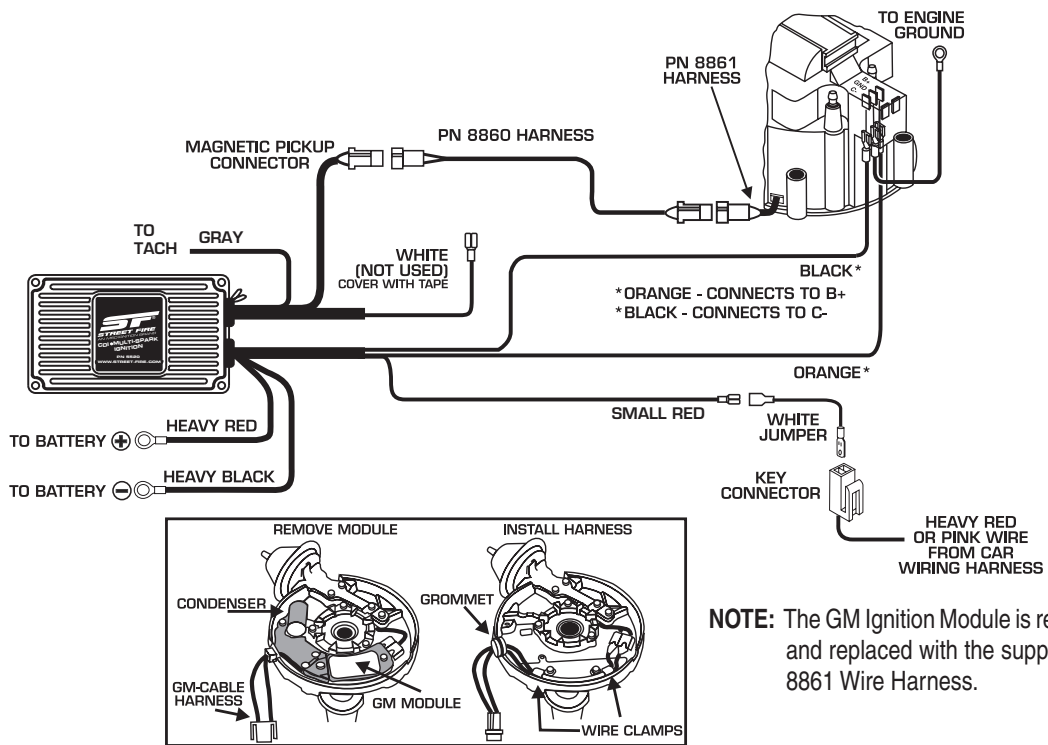

**NOTE:** The GM Ignition Module is removed and replaced with the supplied PN 8861 Wire Harness.

**GM IGNITIONS Wiring an HEI 5 or 7-pin Module (Amplifier Trigger).**

**NOTE:** Some 5-pin models may experience a hesitation or stall on deceleration. If this occurs, contact MSD Tech Line for the required bolt-in diode to correct the problem. MSD Tech Line (915) 855-7123.

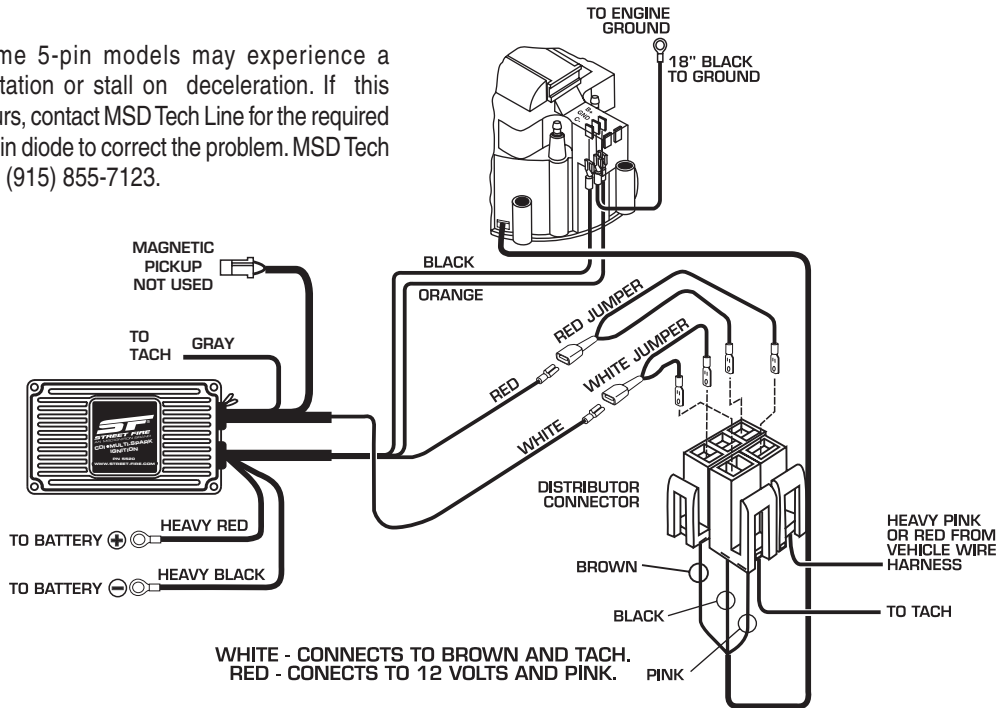

**FORD IGNITIONS Wiring a Ford DuraSpark using White Wire Trigger.**

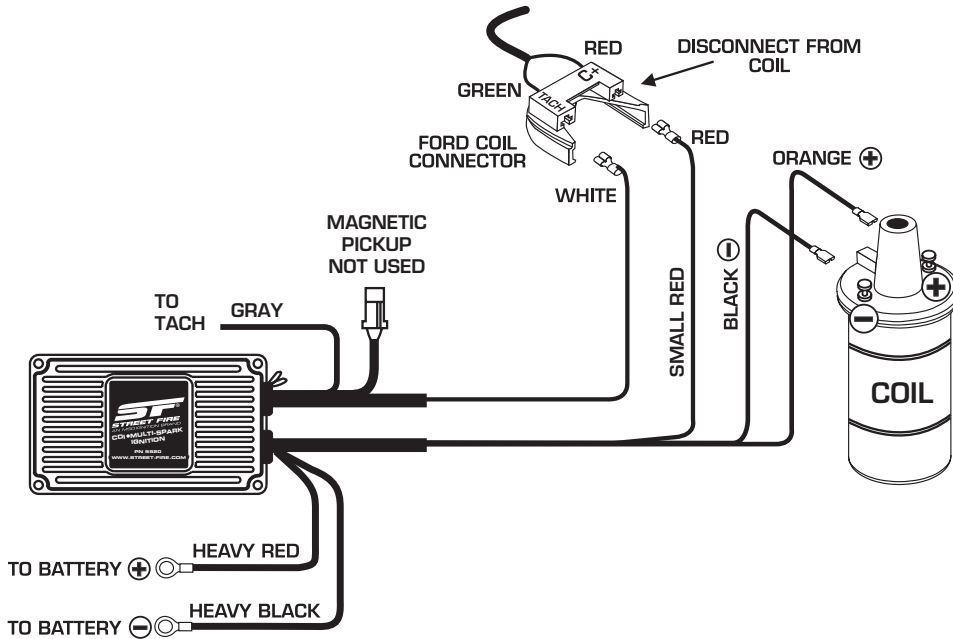

**FORD IGNITIONS** Wiring a Ford DuraSpark using Magnetic Pickup Trigger.

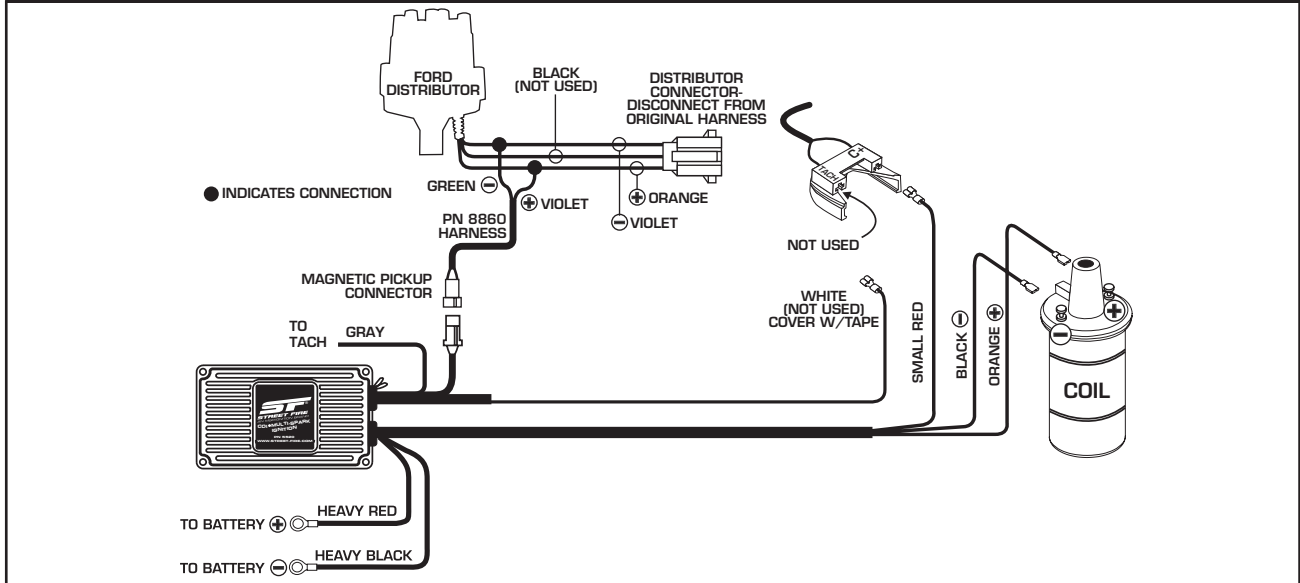

**FORD IGNITIONS** Wiring a Ford TFI with Harness, PN 8874.

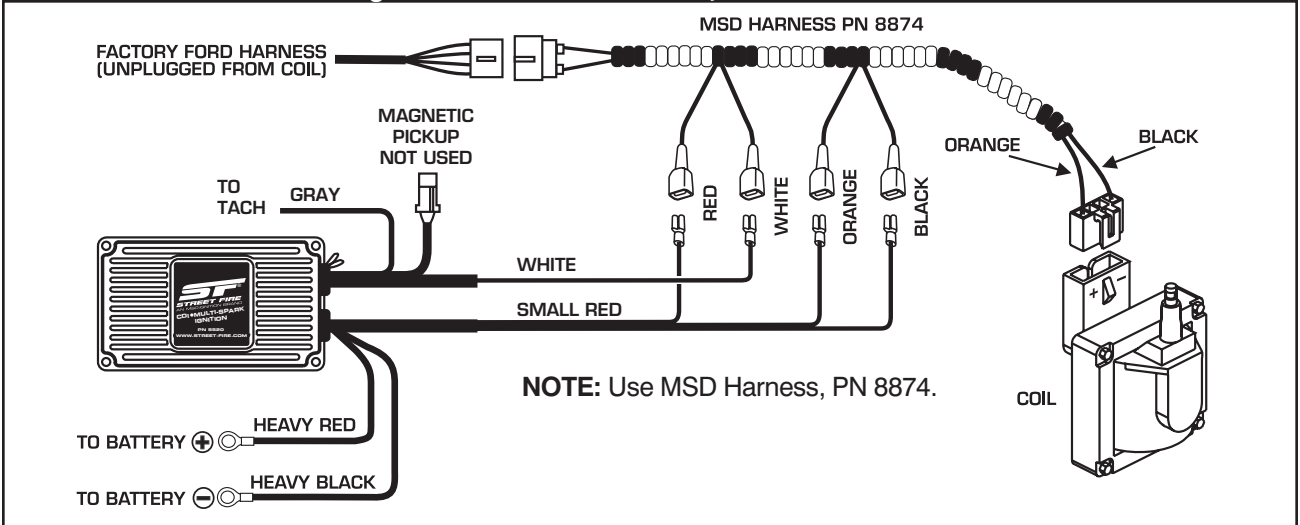

**FORD IGNITIONS** Wiring a Ford TFI (without Harness).

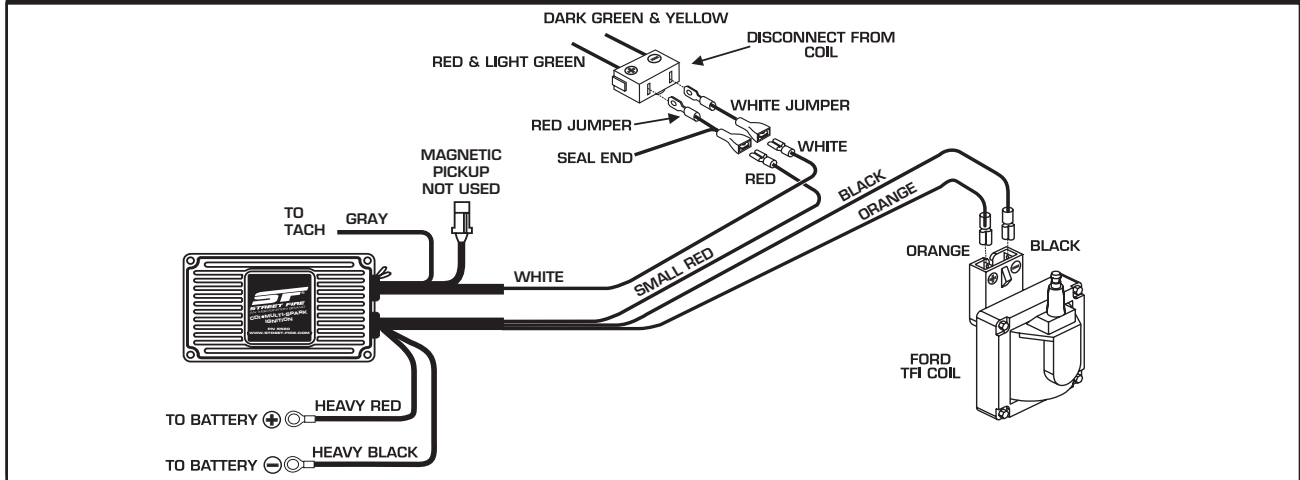

**CHRYSLER IGNITIONS** Wiring a Chrysler Electronic Ignition using Magnetic Pickup Trigger.

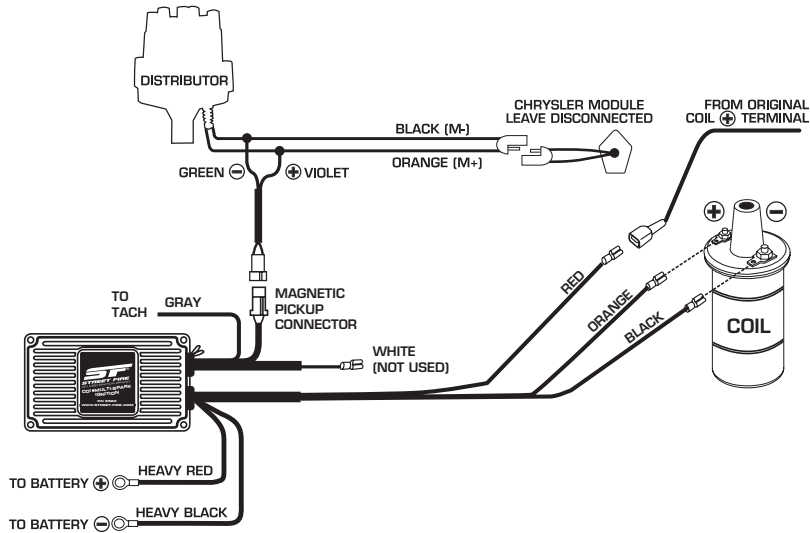

**MSD SYSTEMS** Installing to an MSD Distributor PN 8360.

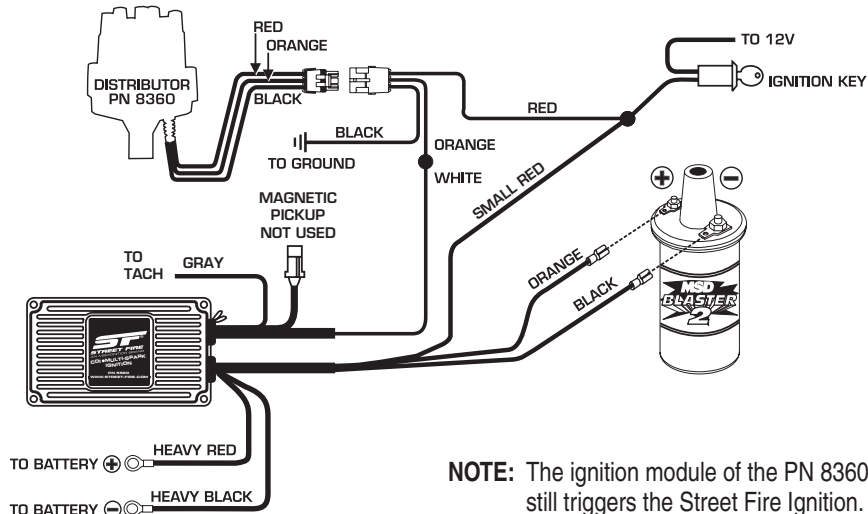

**AFTERMARKET COMPONENTS** Wiring to a Pertronix Ignitor Kit.

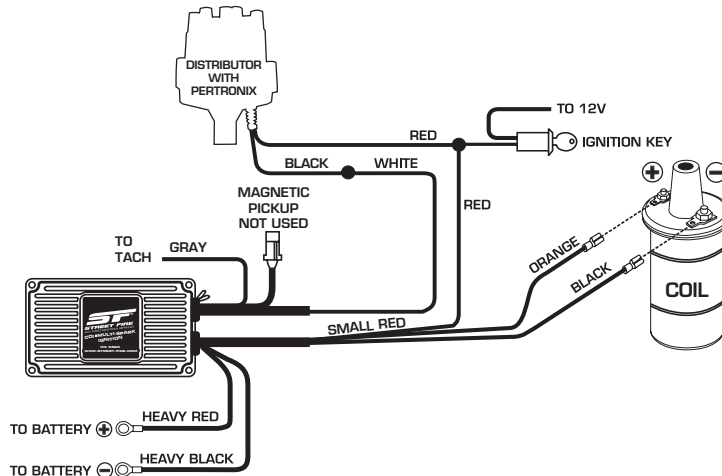



**AFTERMARKET COMPONENTS** Wiring a Mallory Unilite or 9000 Series using Points Trigger.

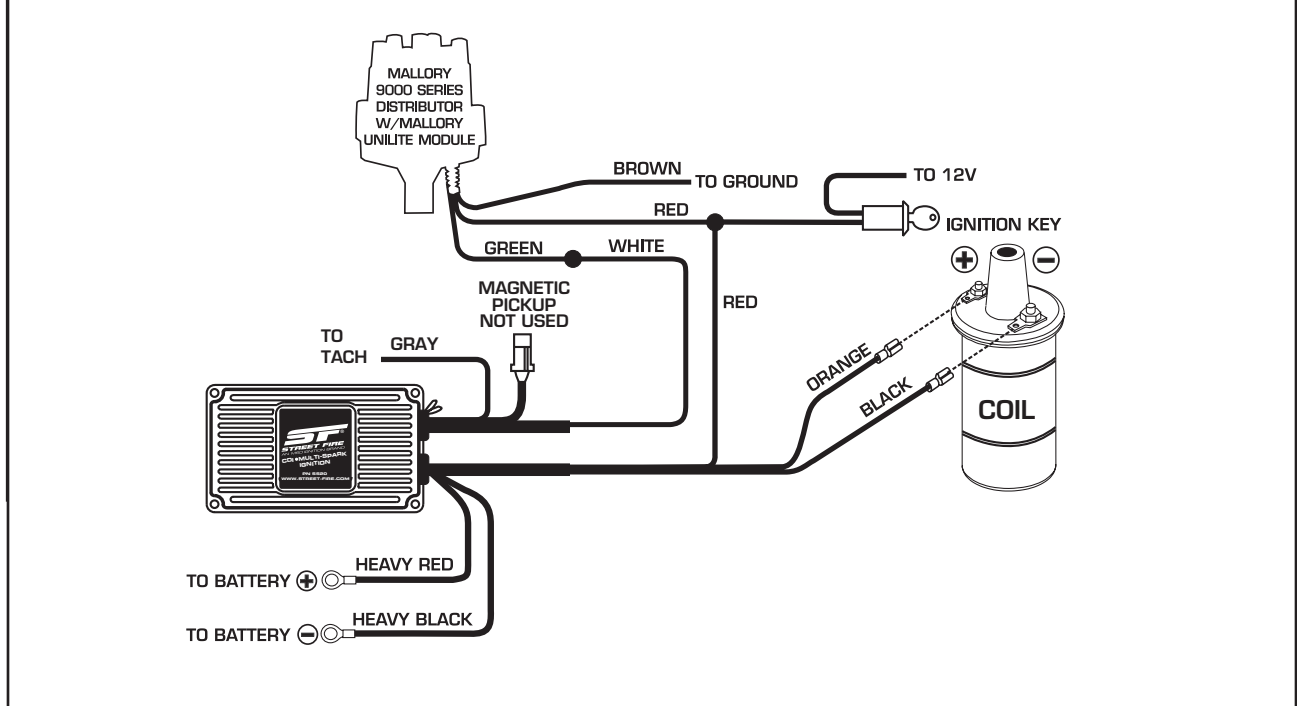

**TROUBLESHOOTING**

Every Street Fire Ignition undergoes numerous quality control checks including a four hour burn-in test. If you experience a problem with your ignition, our research has shown that the majority of problems are due to improper installation or poor connections.

The Troubleshooting section has several checks and tests you can perform to ensure proper installation and operation of the Street Fire Ignition. If you have any questions, call our Customer Support Department at (915) 855-7123, 7 - 6 mountain time.

**TACH/FUEL ADAPTERS**

If your tachometer does not operate correctly or if you experience a no-run situation with your foreign vehicle you probably need a Tach Adapter from MSD Ignition. The chart below lists common tachometers and if an Adapter is necessary.

Tachometer Compatibility List		
AFTERMARKET TACHOMETER	WHITE WIRE TRIGGER	MAGNETIC TRIGGER CONNECTOR
AUTOGAGE	8910	8920
AUTOMETER	NONE	NONE
FORD MOTORSPORTS	NONE	NONE
MALLORY	NONE	NONE
MOROSO	NONE	NONE
STEWART (voltage triggered)	8910	8920
S.W. & BI TORX	NONE	NONE
SUN	8910	8920
VDO	8910	8920
AMC (JEEP)	8910	8920
CHRYSLER	8910	8920
FORD (voltage triggered)	8910	8920
GENERAL MOTORS	Bypass In-Line Filter	Bypass In-line filter
IMPORTS	8910	8920
TOYOTA	8910EIS	

Note: On the list above, the trigger wire on tachometers that are marked NONE may be connected to the Tach Output wire on the Street Fire Ignition.

### NO-RUN ON FOREIGN VEHICLES

Some foreign vehicles with fuel injection systems may require an MSD Tach/Fuel Injection Adapter to run with the Street Fire Ignition. This is because many of these systems use the same trigger source to operate the CDI, the tachometer and the fuel injection. This results in a voltage signal that is too low to accurately trigger the fuel injection. To fix this, an MSD Tach Adapter, PN 8910, will remedy the problem on the majority of vehicles. If the PN 8910 does not fix the problem, the PN 8910-EIS will be required.

**Note:** Toyotas and Ford Probes will require the PN 8910-EIS Adapter.

### INOPERATIVE TACHOMETERS

If your tachometer fails to operate with the CDI installed you may need a Tach Adapter from MSD Ignition. Before getting an Adapter, try connecting your tachometer trigger wire to the Gray Wire. This output produces a 12 volt, square wave (see page 1). If the tach still does not operate, you will need a Tach Adapter. There are two Tach Adapters:

**PN 8920:** If you are using the Magnetic Pickup connector (Green and Violet wires) to trigger the CDI, you will need the PN 8920.

**PN 8910:** If your tachometer was triggered from the coil negative terminal (voltage trigger) and you are using the White wire to trigger the cdi you will need the PN 8910.

### BALLAST RESISTOR

If you have a current trigger tach (originally coil positive) and use the White wire of the CDI, you can purchase a Chrysler Dual Ballast Resistor (used from 1973 - 1976) and wire it as shown in Figure 4.

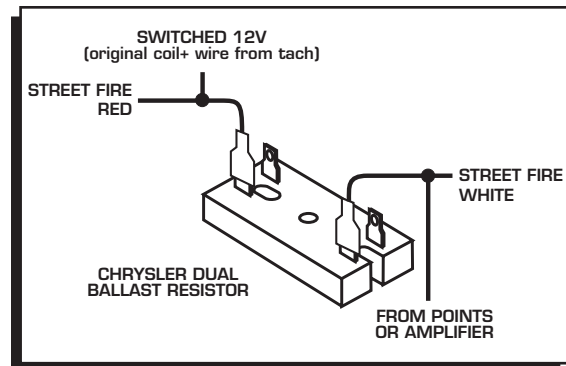

Figure 4 Wiring the Dual Ballast Resistor.

### ENGINE RUN-ON

If your engine continues to run even when the ignition is turned Off you are experiencing engine Run-On. This usually only occurs on older vehicles with an external voltage regulator. Because the CDI receives power directly from the battery, it does not require much current to keep the unit energized. If you are experiencing Run-On, it is due to a small amount of voltage going through the charging lamp indicator and feeding the small Red wire even if the key is turned off.

**Early Ford and GM:** To solve the Run-On problem, a Diode is supplied in the parts bag. By installing this Diode in-line of the wire that goes to the Charging indicator, the voltage is kept from entering the CDI. Figure 5 shows the proper installation for early Ford and GM vehicles.

**Note:** Diodes are used to allow voltage to flow only one way. Make sure the Diode is installed facing the proper direction (as shown in Figure 5).

**Ford:** Install the Diode in-line to the wire going to the #1 terminal.

**GM:** Install the Diode in-line to the wire going to terminal #4.

#### GM 1973 - 1983 with Delcotron Alternators

GM Delcotron Alternators use an internal voltage regulator. Install the Diode in-line on the smallest wire exiting the alternator (Figure 5). It is usually a Brown wire.

### LED

The LED on the side of the Street Fire monitors several operating conditions of the ignition. If the LED indicates that there is a problem with the ignition system, follow the steps through the Troubleshooting section. The LED will appear to be on steady at above idle speeds when everything is functioning properly.

- When 12 volts are applied to the small Red wire, the LED will turn on to indicate power.
- When cranking or running, the LED will blink for each trigger signal.
- If the input voltage drops below 9 volts it will flash at idle speed.
- Code 2 will flash for low battery voltage.
- Code 3 will flash for converter off (ignition problem)

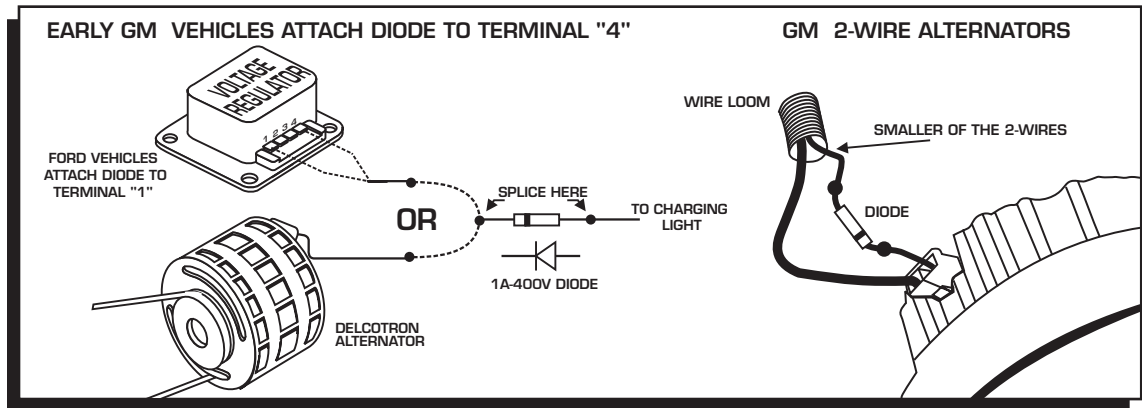

Figure 5 Installing the Diode to fix Run-On.

**Most other applications:** On other applications where engine Run-On is experienced, a Resistor can be put in-line to the Street Fire's small Red wire (Figure 6). This resistor will keep voltage from leaking through to the Street Fire unit.

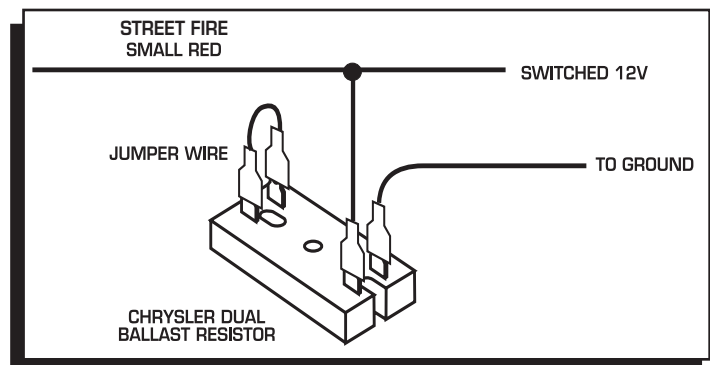

Figure 6 Wiring the Dual Ballast Resistor for Run-On.

**MISSES AND INTERMITTENT PROBLEMS**

Experience at the races has shown that if your engine is experiencing a miss or hesitation at higher rpm, it is usually not directly ignition. Most probable causes include a coil or plug wire failure, arcing from the cap or boot plug to ground or spark ionization inside the cap. Several items to inspect are:

- Always inspect the plug wires at the cap and at the plug for a tight connection and visually inspect for cuts, abrasions or burns.
- Inspect the Primary Coil Wire connections. Because the Street Fire is a Capacitive Discharge ignition and it receives a direct 12 volt source from the battery, there will not be any voltage at the Coil Positive (+) terminal even with the key turned On. During cranking or while the engine is running, very high voltage will be present and no test equipment should be connected.

**WARNING:** Do not touch the coil terminals during cranking or while the engine is running.

- Make sure that the battery is fully charged and the connections are clean and tight. If you are not running an alternator this is an imperative check. If the battery voltage falls below 10 volts during a race, the CDI output voltage will drop.
- Is the engine running lean? Inspect the spark plugs and complete fuel system.
- Inspect all wiring connections for corrosion or damage. Remember to always use proper connections followed by soldering and seal the connections completely.

If everything checks positive, use the following procedure to test the ignition for spark. MSD also offers an Ignition Tester, PN 8998. This tool allows you to check your complete ignition system while it is in the car as well as the operation of rpm limits, activated switches and shift lights.



# INSTALLATION INSTRUCTIONS

## CHECKING FOR SPARK

### If triggering the ignition with the White wire:

1. Make sure the ignition switch is in the "Off" position.
2. Remove the coil wire from the distributor cap and set the terminal approximately 1/2" from ground.
3. Disconnect the White wire from the distributor's points or ignition amplifier.
4. Turn the ignition to the On position. Do not crank the engine.
5. Tap the White wire to ground several times. Each time you pull the wire from ground, a spark should jump from the coil wire to ground (the LED should also blink). If spark is present, the ignition is working properly. If there is no spark skip to step 6.

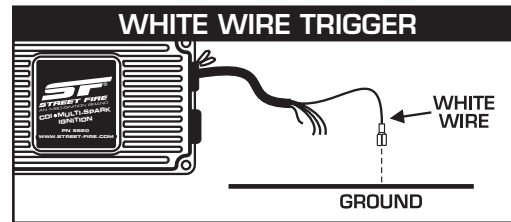

Figure 7 Checking for Spark with the White Wire.

### If triggering with the Magnetic Pickup:

1. Make sure the ignition switch is in the "Off" position.
2. Remove the coil wire from the distributor cap and set the terminal approximately 1/2" from ground.
3. Disconnect the magnetic pickup wires from the distributor.
4. Turn the ignition to the On position. Do not crank the engine.
5. With a small jumper wire, short the magnetic pickup Green and Violet wires together several times. Each time you break this short, a spark should jump from the coil wire to ground (the LED should also blink). If spark is present, the ignition is working properly. If there is no spark skip to step 6.

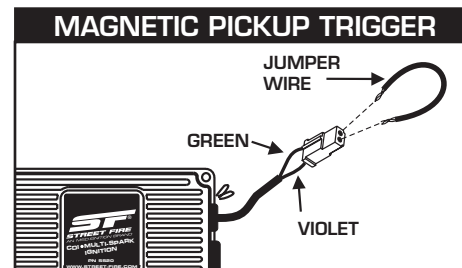

Figure 8 Checking for Spark with Magnetic Pickup.

### 6. If there is no spark:

- A. Inspect all of the wiring.
- B. Substitute another coil and repeat the test. If there is now spark, the coil is at fault.
- C. If there is still no spark, check to make sure there is 12 volts on the small Red wire from the Street Fire Ignition when the key is in the On position. If 12 volts is not present, find another switched 12 volt source and repeat the test.
- D. If, after following the test procedures and inspecting all of the wiring, there is still no spark, the Street Fire Ignition is in need of repair. See the Warranty and Service section for information.

## Service

In case of malfunction, this MSD component will be repaired free of charge according to the terms of the warranty. When returning MSD components for warranty service, **Proof of Purchase** must be supplied for verification. After the warranty period has expired, repair service is based on a minimum and maximum fee.

**All returns must have a Return Material Authorization (RMA) number** issued to them before being returned. To obtain an RMA number please contact MSD Customer Service at 1 (888) MSD-7859 or visit our website at [www.msdpower.com/rma](http://www.msdpower.com/rma) to automatically obtain a number and shipping information.

When returning the unit for repair, leave all wires at the length in which you have them installed. Be sure to include a detailed account of any problems experienced, and what components and accessories are installed on the vehicle. The repaired unit will be returned as soon as possible using Ground shipping methods (ground shipping is covered by warranty). For more information, call MSD at (915) 855-7123. MSD technicians are available from 7:00 a.m. to 5:00 p.m. Monday - Friday (mountain time).

## Limited Warranty

MSD warrants this product to be free from defects in material and workmanship under its intended normal use\*, when properly installed and purchased from an authorized MSD dealer, for a period of one year from the date of the original purchase. This warranty is void for any products purchased through auction websites. If found to be defective as mentioned above, it will be repaired or replaced at the option of MSD. Any item that is covered under this warranty will be returned free of charge using Ground shipping methods.

This shall constitute the sole remedy of the purchaser and the sole liability of MSD. To the extent permitted by law, the foregoing is exclusive and in lieu of all other warranties or representation whether expressed or implied, including any implied warranty of merchantability or fitness. In no event shall MSD or its suppliers be liable for special or consequential damages.

\*Intended normal use means that this item is being used as was originally intended and for the original application as sold by MSD. Any modifications to this item or if it is used on an application other than what MSD markets the product, the warranty will be void. It is the sole responsibility of the customer to determine that this item will work for the application they are intending. MSD will accept no liability for custom applications.