



IQS211 Datasheet

Single Channel Capacitive Proximity/Touch Controller with movement detection

The IQS211 ProxSense® IC is a self-capacitance controller designed for applications where an awake/activate on proximity/touch function is required. The IQS211 uses movement detection for applications that require long term detection. The IQS211 operates standalone or I²C and can be configured via OTP (One Time Programmable) bits.

Features

- Pin compatible with IQS127/128/227/228
- **Automatic Tuning Implementation (ATI)**
- On-chip movement detection algorithm
- Forced activation when movement detected
- Minimal external components
- 25mm detection distance
- Up to 60pF sensor load (with effective movement detection)
- Multiple **One-Time-Programmable (OTP)** options
- **Standalone** direct outputs:
 - Primary output (configurable)
Default: **ACTIVATION**
 - Secondary output (configurable)
Default: **MOVEMENT**
- Standard **I²C** interface (polling)
- Alternate **I²C** interfaces (Ready signal integrated onto **I²C** clock line):
 - I²C configuration at start-up with standalone runtime operation
 - I²C with wake-up
- **1-Wire streaming** interface:
 - 1-Wire & event CLK signal

RoHS2
Compliant

6 pin TSOT23-6
Representations only,
not actual markings

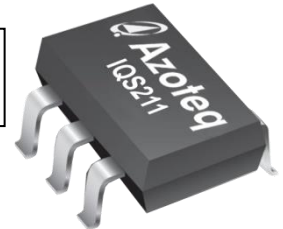

- **Special configurations:**
 - Activation based on capacitive load at power-on
- **Separate MOVEMENT output selection:** Pulse Frequency Modulation (PFM, default), Pulse Width Modulation (PWM), Latched, or PWM only active in activation
- **Low power consumption:** 80uA (50 Hz response), 20uA (20 Hz response) and 4uA (LP mode, zoom to scanning mode with wake-up)
- **Low power options:**
 - Low power without activation
 - Low power within activation
 - Low power standby modes with proximity wake-up / reset wake-up
- **Internal Capacitor Implementation (ICI)**
- Supply voltage: 1.8V to 3.6V
- Low profile TSOT23-6 package

Applications

- Wearable devices
- Movement detection devices (fitness, anti-theft)
- White goods and appliances
- Human Interface Devices
- Proximity activated backlighting
- Applications with long-term activation

Available Packages

| T _A | TSOT23-6 |
|----------------|----------|
| -40°C to 85°C | IQS211 |



1 Overview

1.1 Device characteristics

The IQS211 is a device tailored for long-term proximity or touch activations. It mainly offers two digital output pins, one with an activation threshold for large capacitive shifts and the other with a

mode also has access to all these settings.

The movement output may be chosen to have a specific characteristic. This may be PFM (movement intensity via pulse count per time window), PWM, latched output or PWM combined with the normal threshold activation.

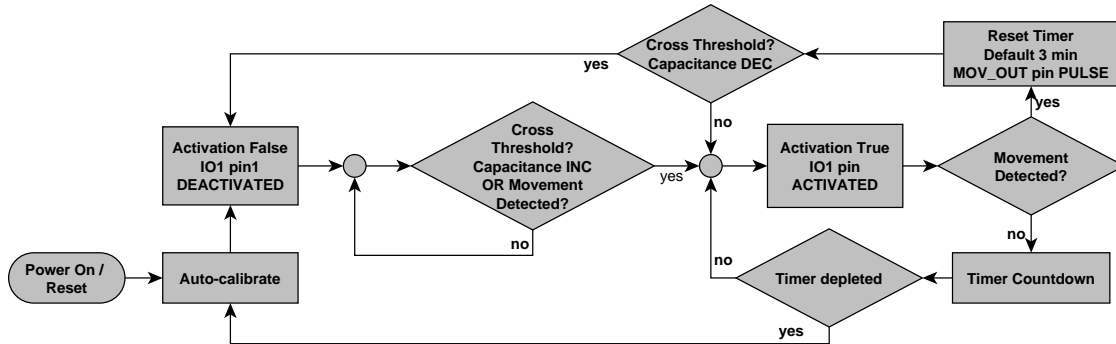

Figure 1.1 Flow diagram of the typical IQS211 movement based user interface

threshold for small movements even during a normal activation. There are also a few options to combine these two digital outputs where the application only allows for 1 output pin. These two outputs may be read via the IC pins in standalone mode or used for communications via I²C or 1-Wire streaming mode.

Various configurations are available via [one-time programmable \(OTP\) options](#). I²C

1.1.1 Normal threshold operation

With a normal activation (hand brought close) the output will become active. The output will de-activate as soon as the action is reversed (hand taken away). In addition a separate movement output will become active when movement is detected according to a movement threshold. Movement may be detected before the

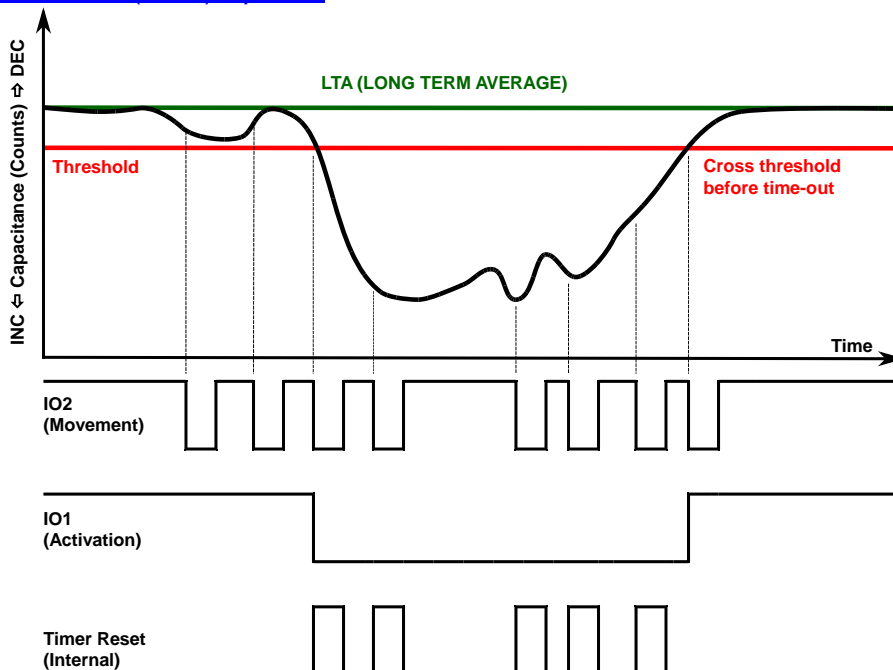

Figure 1.2 Plot of IQS211 streaming data along with the digital response

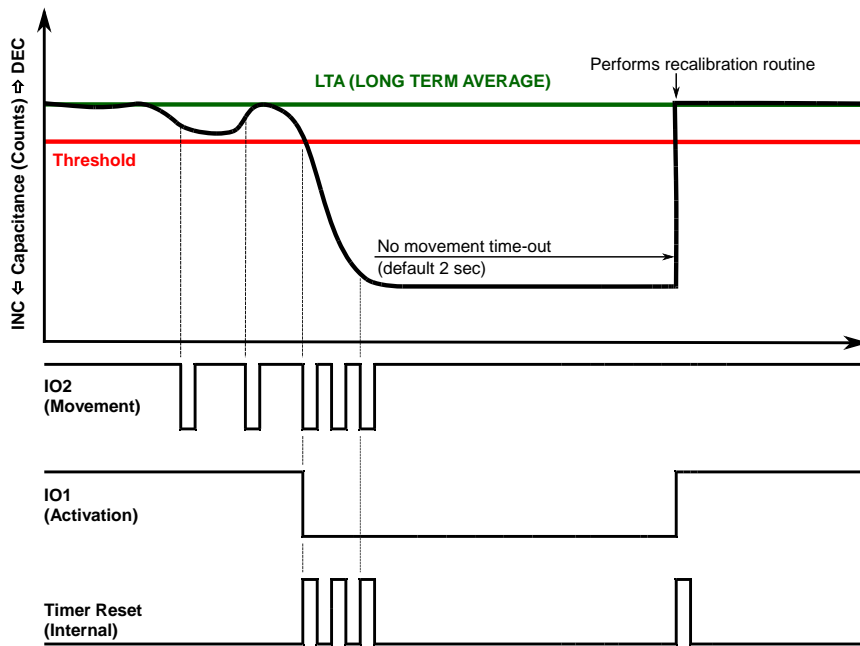

Figure 1.3 Example of a time-out event with re-calibration

normal threshold is crossed. Movement detection is done via a completely separate digital filter while improving the efficiency of the sensor output (timer reset on movement).

In a normal activation the output will stay active for as long as movements are detected. A time-out timer (configurable time) will be reset with each movement.

1.1.2 Output forced by movement

There is the option to force the output active for each movement detected. The output will be cleared as soon as there is no movement for the selected timer period.

1.1.3 Long term recovery

When changing the sensor capacitive environment, the sensor will adapt to the new environment. If the new environment decreases capacitance (wooden table to air), the sensor will rapidly adapt in order to accept new human activations. If the new environment increases capacitance (like air to steel table), the sensor will remain in activation until a time-out occurs (as seen in Figure 1.3) or until the device is returned to its previous environment.

When the timer runs out, the output will be de-activated. Re-calibration is possible after de-activation because the timer will only time-out with no movement around the sensor.

1.1.4 Choosing a user interface

The user interface can be defined via [OTP options](#) or via an [I²C register](#)

ACTIVATION & MOVEMENT UI

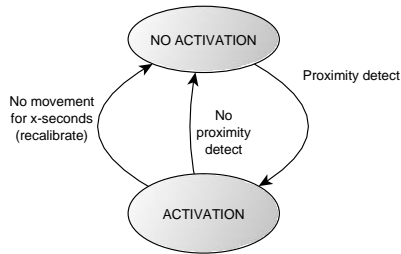

Figure 1.4 ACTIVATION & MOVEMENT UI state diagram

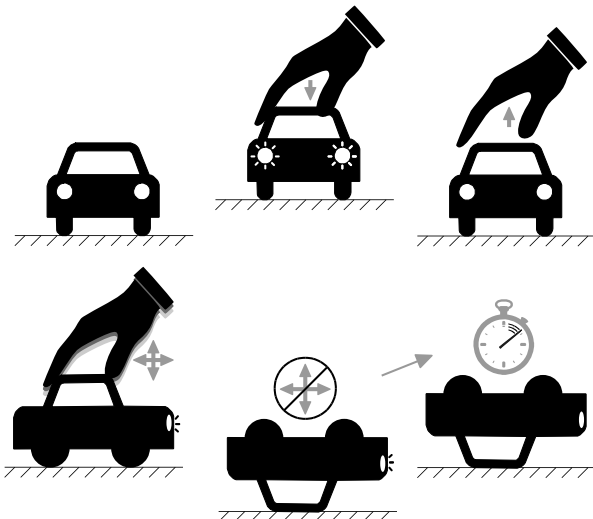

Figure 1.5 Toy car example of default UI

1. Lights off
2. Touch roof, lights on
3. No touch on roof, lights off
4. While in use (movement), lights on
5. Roof on ground = touch
6. No movement causes time-out, lights off

MOVEMENT LATCH & MOVEMENT UI

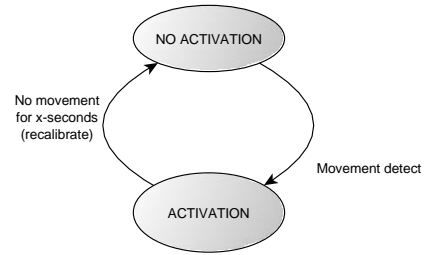

Figure 1.6 MOVEMENT LATCH UI state diagram

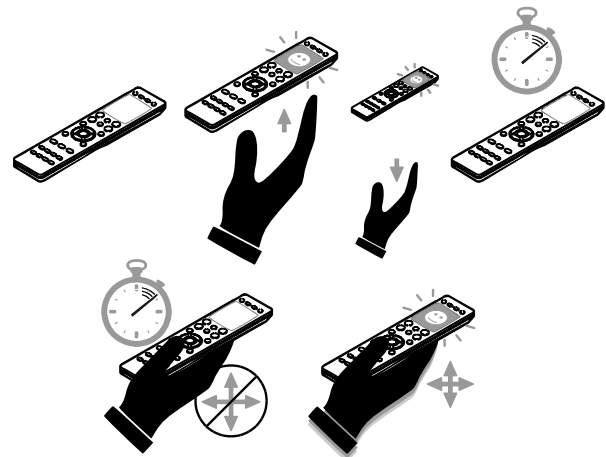

Figure 1.7 Remote control example of movement latch UI application

1. Remote backlight/LCD off
2. Hand close to remote = LCD on
3. Hand away, then LCD remains on
4. LCD off after no movement time-out
5. If remote in hand, but LCD off, then any small movement turns on LCD.
6. While in hand and movement, LCD remains on.

MOVEMENT & INPUT UI

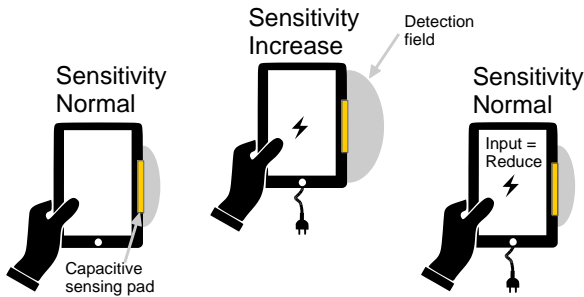

Figure 1.8 Device charging example of input UI

Device is operating on battery with designed sensitivity

Device is plugged-in for charging

Device ground reference changes and sensitivity increases

Input is given to reduce sensitivity

PROX & TOUCH UI

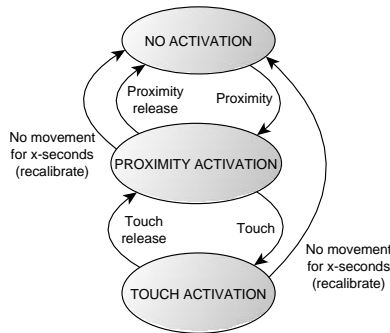

Figure 1.9 Proximity and touch state diagram

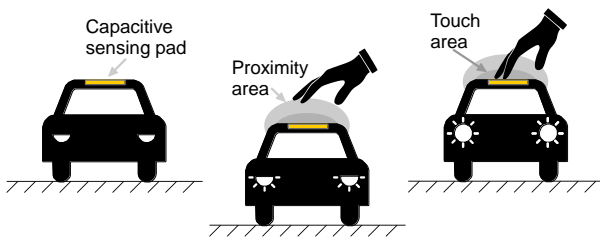

Figure 1.10 Proximity and touch UI example

Proximity to the device activates proximity output

Touching the device activates the touch output (proximity remains triggered)

Movement features are integrated and function the same as in the default “ACTIVATION & MOVEMENT” user interface

1.1.5 Integrated features

The device includes an internal voltage regulator and reference capacitor (C_s).

Various advanced signal processing techniques are combined for creating a robust solution.

These techniques include:

- Movement detection filter (to release an activation in the case of inactivity)
- Advanced noise filtering on incoming sample stream
- Superior methods of parasitic capacitance compensation while preserving sensitivity
- Unique option for capacitive load dependant activation on power-on

1.1.6 Communications protocols

The IQS211 offers a wide range of data streaming modes each with a specific purpose.

Standard 2-wire I²C polling is offered to access the [entire range of settings and data](#) offered by the IQS211.

Another I²C option allows the device to be configured via I²C then jump to any of the other modes when the communication window is closed. This option is offered to give full control over selecting settings while simplifying the main-loop code by only responding to direct digital outputs. The digital output pair will contain signature pulses to indicate power-on reset or an unexpected reset occurrence. I²C configuration should be re-initiated in the event of an IQS211 reset.

A 1-wire data streaming interface is offered for access to a variety of data over a single line. The 1-wire implementation may be enhanced (by using the IO2 pin) by only reading data when the IO2 clock pin toggles. The clock pin will only toggle when an event is active and produce a clock signal during this active period.



1.1.7 Automatic Calibration

Proven Automatic Tuning Implementation (ATI) algorithms are used to calibrate the device to the sense electrode. This algorithm is optimised for applications where a fixed detection distance (in mid-air) is required for failure safe detection.

1.1.8 Capacitive sensing method

The *charge transfer* method of capacitive sensing is employed on the IQS211. (The charge transfer principle is thoroughly described in the application note: "[AZD004 - Azoteq Capacitive Sensing](#)".)

1.2 Operation

1.2.1 Device Setup

The device may be purchased pre-configured (large orders or popular configurations), programmed in-circuit during production or simply setup via I²C.

1.2.2 Movement filter response

The movement filter runs continually and the dedicated digital output will activate in PFM (pulse frequency modulation), PWM or latched mode.

1.2.3 External control

With certain user interfaces, the "multifunction IO2" (optional line to connect to master device) can be used to signal:

- a "halt (sleep mode) and reseed" or "reduce sensitivity" in MOV&INPUT mode.
- a "halt (sleep mode) and reseed" in ACT&MOV mode. When enabled, the ACT output reads the input periodically.

RESEED

A short pulse ($t > 15\text{ms}$, $t < 25\text{ms}$) will force the reference counts (long-term average) to match the actual counts (capacitance of sensor). The short pulse

for a reseed operation also applies to the user configurable input option: "Reduce sensitivity".

HALT CHARGE (& RESET)

By writing the pin low for a longer time ($t > 50\text{ms}$), will force the IC into "halt charge" for low current consumption. It is important to consider current through the pull-up resistor when in sleep mode.

The IC will perform a soft reset as soon as the pin is released after 50ms or more. With a soft reset the IC will remember the activation state when going into the "halt charge" mode. The state will be recalled at the reset operation and cleared along with the calibration.

In order to achieve a "halt charge" state with minimal power consumption it is recommended to configure the MCU output as push-pull for the input pin and perform the "halt charge". With the "movement latch" function defined, do the operation twice to clear a possible activation at the time of calling a "halt charge".

REDUCE SENSITIVITY

With a configurable bit the system sensitivity may be changed. The input may be used to reduce sensitivity in the following way:

- AC filter doubles in strength
- Proximity threshold (filter halt) is increased by 4 counts
- Activation threshold is increased by 10 counts
- Movement sensitivity threshold is not changed



1.2.4 Low power options

Various low-power configurations are offered in order to achieve the required current consumption during activated and non-activated conditions.

These low power configurations make the power consumption and product response highly configurable during various events.

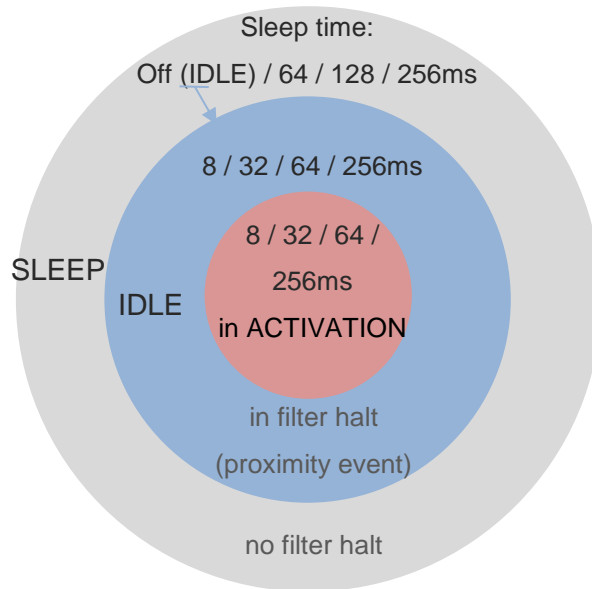
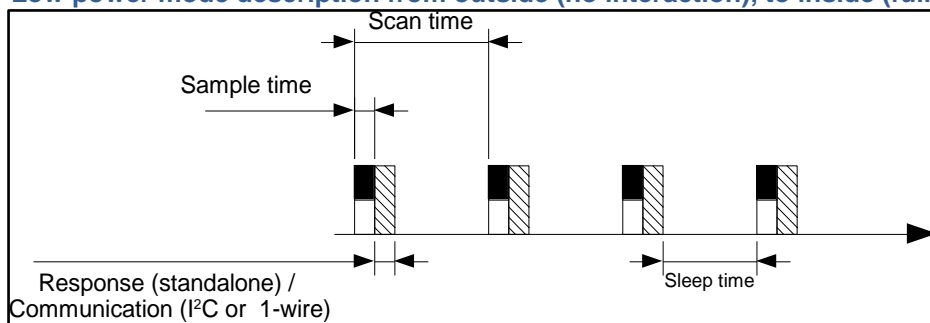

Figure 1.11 Low power mode description from outside (no interaction), to inside (full interaction)



1.3 Applicability

All specifications, except where specifically mentioned otherwise, provided by this datasheet are applicable to the following ranges:

Temperature: -40C to +85C

Supply voltage (V_{DDHI}): 1.8V to 3.6V

2 Packaging and Pin-Out

The IQS211 is available in a TSOT23-6 package.

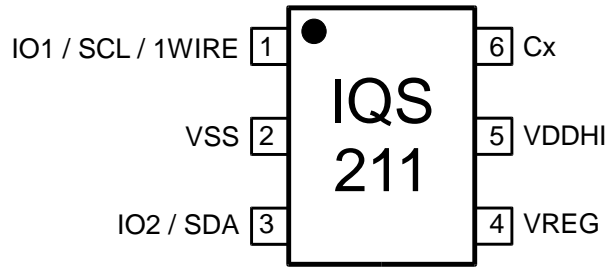

Figure 2.1 IQS211 pin-out (TSOT23-6 package)

Table 2.1 Pin-out description

| IQS211 in TSOT23-6 | | | |
|--------------------|---------------|----------------------|------------------------------------------------------------------------------------------------|
| Pin | Name | Type | Function |
| 1 | PRIMARY I/O | Digital Input/Output | Multifunction IO1 / SCL (I ² C Clock signal) / 1WIRE (data streaming) |
| 2 | VSS | Signal GND | |
| 3 | SECONDARY I/O | Digital Input/Output | Multifunction IO2 / SDA (I ² C Data output) |
| 4 | VREG | Regulator output | Requires external capacitor |
| 5 | VDDHI | Supply Input | Supply: 1.8V – 3.6V |
| 6 | Cx | Sense electrode | Connect to conductive area intended for sensor |

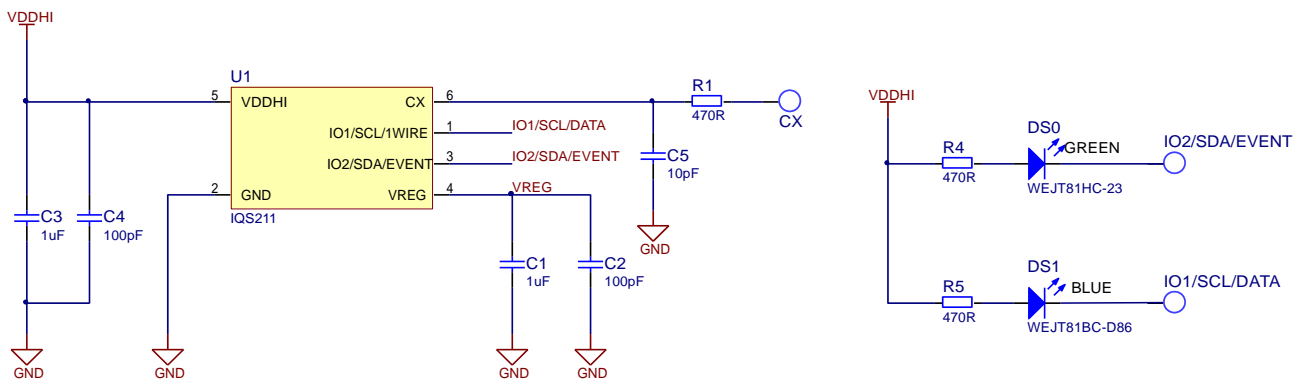

Figure 2.2 IQS211 reference schematic

Figure 2.2 shows the following:

- Schematic for default power mode, see guide for capacitor selection in low power modes below:

| Sleep time | 8ms (default) - 32ms | 64ms | 128ms | 256ms |
|--------------------------|----------------------------------|------------------------------------|--------------------------------------|-------------------------------------|
| Capacitor recommendation | C1 = 1 μ F C3 = 1 μ F | C1 = 1 μ F C3 = 2.2 μ F | C1 = 2.2 μ F C3 = 4.7 μ F | C1 = 4.7 μ F C3 = 10 μ F |

- C5 = 10pF load. This can be changed for slight variations in sensitivity. The recommended value is 1pF to 60pF, depending on the capacitance of the rest of the layout.
- R1 = 470 Ω 0603 for added ESD protection



3 Configuration Options

The IQS211 offers various user selectable options. These options may be selected via I²C setup or one-time programmable (OTP) configuration. OTP settings may be ordered pre-programmed for bulk orders or in-circuit programming techniques may be implemented during the product testing phase. I²C setup allows access to all device settings while entering direct output mode as soon as selected by the MCU.

Azoteq offers a Configuration Tool (CT210 or later) and associated software that can be used to program the OTP user options for prototyping purposes. For further information regarding this subject, please contact your local distributor or submit enquiries to Azoteq at: ProxSenseSupport@azoteq.com



3.1 User Selectable OTP options

User Selectable OTP options : Bank0

| bit7 | Bank 0 | | | | | | bit0 |
|--------------|--------------|-------------------|-------------------|------------------|------------------|------------------------|------------------------|
| Base value 1 | Base value 0 | Sleep scan time 1 | Sleep scan time 0 | Idle scan time 1 | Idle scan time 0 | Activation scan time 1 | Activation scan time 0 |

| | |
|-----------------------|-----------------------------------------------------------------------------------------------|
| Bank0: bit 7:6 | Base Value (Sensitivity Multiplier in Partial ATI mode) |
| | 00 = 150 (0, most sensitive) 01 = 100 (1) 10 = 200 (2) 11 = 250 (3, least sensitive) |
| Bank0: bit 5:4 | SLEEP scan time |
| | 00 = off (refer to IDLE scan time) 01 = 64ms 10 = 128ms 11 = 256ms |
| Bank0: bit 3:2 | IDLE scan time (proximity/halt scan time) |
| | 00 = 8ms 01 = 32ms 10 = 64ms 11 = 256ms |
| Bank0: bit 1:0 | ACTIVATION scan time |
| | 00 = 8ms 01 = 32ms 10 = 64ms 11 = 256ms |



User Selectable OTP options : Bank1

| bit7 | Bank 1 | | | | | | bit0 |
|--------------|------------------|------------------|-------------------|-------------------|-------------------|----------------------|----------------------|
| Late Release | Prox threshold 1 | Prox threshold 0 | Touch threshold 2 | Touch threshold 1 | Touch threshold 0 | Movement threshold 1 | Movement threshold 0 |

| | | | |
|-----------------------|------------------------------------------------------------------------------------------------------|----------------------------|-----------------------------|
| Bank1: bit 7 | Touch late release (50% of touch threshold) | | |
| | 0 = Disabled 1 = Enabled | | |
| Bank1: bit 6:5 | Proximity threshold (delta counts from LTA) | | |
| | 00 = 4 counts (6 counts when "SLEEP scan time" enabled) 01 = 2 (4) 10 = 8 (10) 11 = 16 (18) | | |
| Bank1: bit 4:2 | Touch threshold (delta percentage from LTA) delta counts from LTA | | |
| | Ratio: | Counts (LTA = 768): | Counts (LTA = 1200): |
| | 000 = 6 / 256 | 000 = 18 | 000 = 28 |
| | 001 = 1 | 001 = 3 | 001 = 4 |
| | 010 = 2 | 010 = 6 | 010 = 9 |
| | 011 = 3 | 011 = 9 | 011 = 14 |
| | 100 = 4 | 100 = 12 | 100 = 18 |
| | 101 = 15 | 101 = 45 | 101 = 70 |
| | 110 = 60 | 110 = 180 | 110 = 281 |
| | 111 = 96 | 111 = 270 | 111 = 421 |
| Bank1: bit 1:0 | Movement threshold (delta counts from movement average) | | |
| | 00 = 3 01 = 6 10 = 15 11 = 25 | | |



User Selectable OTP options : Bank2

| bit7 | Bank 2 | | | | | | bit0 |
|----------------|----------------|----------------|-------------------|-------------------|----------------|----------------|----------------|
| Reseed timer 2 | Reseed timer 1 | Reseed timer 0 | Movement output 1 | Movement output 0 | UI selection 2 | UI selection 1 | UI selection 0 |

| | |
|-----------------------|---------------------------------------------------------------------------------------------------------------------------------------------------------------------------------------------------------------------------------------------------------------------------------------------------------------------------------------------------------------------------------------------------------------------------------------------------------------------------------------------------------------------------------------------------------------------------------------------------------------------------------------------------------------------------------------------------------------------------------------------------------------------------------------------------------------------------------------------------------------------------------------------------------------------------------------------|
| Bank2: bit 7:5 | Reseed after no movement timer |
| | 000 = 2 sec 001 = 5 sec 010 = 20 sec 011 = 1 min 100 = 2 min 101 = 10 min 110 = 60 min 111 = always halt (never timer-out) |
| Bank2: bit 4:3 | Movement output type |
| | 00 = PFM (pulse frequency modulation) see Figure 3.2 01 = PWM (see Figure 3.3) 10 = Latched (forces output for duration of timer) See Figure 3.4 11 = PFM (only active during activation) |
| Bank2: bit 2:0 | User interface selection (select function of IO1 and IO2) |
| | 000 = IO1 : Activation; IO2 : Movement 001 = IO1 : Movement latch output (forced); IO2 : Movement 010 = IO1 : Movement; IO2 : Input 011 = IO1 : Touch; IO2 : Prox 100 = IO1 : 1-wire data; IO2 : 1-wire clock (only on events: prox, touch, movement) 101 = IO1 : I ² C data; IO2 : I ² C clock (normal polling for use on I ² C bus) 110 = IO1 : I ² C data; IO2 : I ² C clock (with signature pulses at power-up / reset). The clock also has a RDY pulse incorporated before each possible communications window. 111 = IO1 : I ² C data; IO2 : I ² C clock. The clock also has a RDY pulse incorporated before each possible communications window. The IC will wake-up on I ² C bus pin changes. |



User Selectable OTP options : Bank3

| bit7 | Bank 3 | | | | | | bit0 |
|------------|------------|------------|------------|--------------|-----------|------------------|-------------------|
| System use | System use | System use | System use | Reserved ALS | AC filter | Input definition | Activation output |

| | |
|--------------|-----------------------------------------------------------------------------------------------------------------------------------------------------------------------------------------------------------------------------------------------------------------------------------------------------------------------------------------------------------------------------------------------|
| Bank3: bit7 | System Use |
| Bank3: bit6 | System Use |
| Bank3: bit5 | System Use |
| Bank3: bit4 | System Use |
| Bank3: bit 3 | Reserved ALS |
| Bank3: bit 2 | AC filter increase 0 = disabled 1 = enabled (increased filtering for noise reduction, increase activation level with 10 counts, halt level with 4 counts) |
| Bank3: bit 1 | Multifunction Bit (applies only to certain UIs) Output definition: "000" Activation & Movement UI: 0 = Normal Activation 1 = Activation with counts on PWM Input definition: "010" Movement & Input UI: 0 = Halt charge / reseed 1 = Reduce sensitivity (increase filter, increase touch threshold 10 counts, increase halt with 4 counts) |
| Bank3: bit 0 | Activation output with input reseed & reset (halt charge) feature 0 = Disabled 1 = Enabled |



User Selectable OTP options : Bank4

| bit7 | Bank 4 | | | | | | bit0 |
|------------|------------|------------|------------|------------|-------------|------------|-----------------|
| System use | System use | System use | System use | System use | Partial ATI | ATI target | Auto Activation |

| | |
|--------------|-----------------------------------------------------------------------------------------------------------------------------------------------------------------|
| Bank4: bit7 | System Use |
| Bank4: bit6 | System Use |
| Bank4: bit5 | System Use |
| Bank4: bit4 | System Use |
| Bank4: bit 3 | System Use |
| Bank4: bit 2 | Partial ATI |
| | 0 = disabled 1 = enabled |
| Bank4: bit 1 | ATI target |
| | 0 = 768 1 = 1200 |
| Bank4: bit 0 | Auto Activation at power-up when P>7 (absolute capacitance detection method, partial ATI must be enabled, select sensitivity with the “Sensitivity Multiplier”) |
| | 0 = Disabled 1 = Enabled |

3.2 Details on user configurable options

3.2.1 Bank 0: Sensitivity and scan time adjustments

| | |
|-----------------------|----------------------------------------------------------------|
| Bank0: bit 7:6 | Base Value (Sensitivity Multiplier in Partial ATI mode) |
|-----------------------|----------------------------------------------------------------|

Changing the base value enables the designer to adjust sensitivity. Lower base values will increase sensitivity and are recommended for systems with a high SNR ratio. Higher base values will prevent noise from being amplified, but will result in less sensitivity.

With **Bank4: bit 2** set (partial ATI), the area of operation may be fixed to a certain extent. This is ideal for stationary applications where a specific type of trigger is expected.

With **Bank4: bit 0** set (auto-activation $P > 7$), partial ATI must be enabled to ensure the desired results. With the “Sensitivity Multiplier” fixed, the P value will indicate whether a certain threshold has been crossed at power-up.

| | |
|-----------------------|------------------------|
| Bank0: bit 5:4 | SLEEP scan time |
|-----------------------|------------------------|

Select a SLEEP scan time to save power while a device is not in use. A proximity event will wake the IQS211 from sleep mode and enter the IDLE mode.

| | |
|-----------------------|--------------------------------------------------|
| Bank0: bit 3:2 | IDLE scan time (proximity/halt scan time) |
|-----------------------|--------------------------------------------------|

Select an IDLE scan time to change the reaction time and power consumption while in the proximity state before entering either the activation state or “no proximity” state.

| | |
|-----------------------|-----------------------------|
| Bank0: bit 1:0 | ACTIVATION scan time |
|-----------------------|-----------------------------|

Select an ACTIVATION scan time to change the reaction time and power consumption within activation. This flexibility was added specifically for body-worn devices with long-term activations. The reaction time may therefore be tailored for ideal response while being in a low power state.

3.2.2 Bank 1: Threshold adjustments

| | |
|---------------------|----------------------------------------------------|
| Bank1: bit 7 | Touch late release (50% of touch threshold) |
|---------------------|----------------------------------------------------|

This option will enable a user interface where activation would occur as usual, but the deactivation will occur at a relaxed threshold. It will therefore counter unwanted false releases. This option is ideal for handheld devices that will active with a typical “grab” action, but will not release when the grip on the device is relaxed.

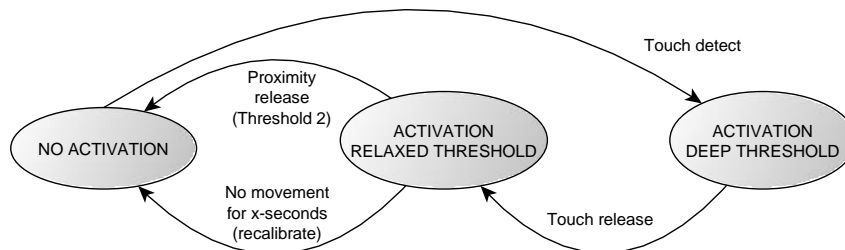

Figure 3.1 State diagram of touch late release interface



| | |
|-----------------------|----------------------------------------------------|
| Bank1: bit 6:5 | Proximity threshold (delta counts from LTA) |
|-----------------------|----------------------------------------------------|

The proximity threshold may be chosen to halt the filters that allow for temperature drift and other environmental effects. Choose a low value in order to increase the trigger distance for slow proximity activations. Choose a high value if the device and/or sensing electrode overlay is in a highly variable temperature environment. A high value is also recommended for touch button implementations with the IQS211. This threshold will not trigger any of the output signals in most of the user interface options. The result of this threshold becomes an output in the “Proximity and touch” user interface option, where movement is only operating in the background.

| | |
|-----------------------|----------------------------------------------------|
| Bank1: bit 4:2 | Touch threshold (delta percentage from LTA) |
|-----------------------|----------------------------------------------------|

The touch threshold is the highly variable threshold that will determine the triggering of the activation output. This threshold may be chosen for various proximity trigger distances (low values 1 to 15) including a few settings that allow for the implementation of a touch button (high values 15 to 90)

| | |
|-----------------------|----------------------------------------------------------------|
| Bank1: bit 1:0 | Movement threshold (delta counts from movement average) |
|-----------------------|----------------------------------------------------------------|

The movement threshold is chosen according to the dynamic response longed for, but also according to the signal-to-noise ratio of the system. Battery powered applications generally deliver much higher SNR values, allowing for lower movement thresholds.

3.2.3 Bank 2: Timer, output type and user interface adjustment

| | |
|-----------------------|---------------------------------------|
| Bank2: bit 7:5 | Reseed after no movement timer |
|-----------------------|---------------------------------------|

Depending on the user interface chosen, the activation output will clear when no movement is detected for the period selected here. This feature enables long-term detection in interactive applications while eliminating the risk of a device becoming stuck when placed on an inanimate object.

| | |
|-----------------------|-----------------------------|
| Bank2: bit 4:3 | Movement output type |
|-----------------------|-----------------------------|

The movement output is a secondary output (normally IO2 pin) that may be used as the main output or supporting output. This output may be altered to suit the requirements of various applications. When user interface of “**IO1**: Movement; **IO2**: Input” is selected this output will be at the IO1 pin.

‘00’ – The default pulse frequency modulated (PFM) signal indicates intensity of movement by the density of pulses. This is a relatively slow output that may trigger occasional interrupts on the master side. See Figure 3.2. Most intense detectable movements are indicated by active low pulses with 10ms width (20ms period). Saturated movement intensity is indicated by a constant low.

‘01’ – The pulse width modulation (PWM) option is ideal for driving analogue loads. This signal runs at 1 kHz and the duty cycle is adapted according to the movement intensity.

‘10’ – The movement latched option triggers the output as soon as any movement is detected. The output only clears when no movement is sensed for the time defined in Bank2: bit 7:5.

‘11’ – The same PFM-type output as in the ‘00’ setting, but here the output will only become active once the activation threshold is reached.

'00' – PFM (pulse frequency modulation)

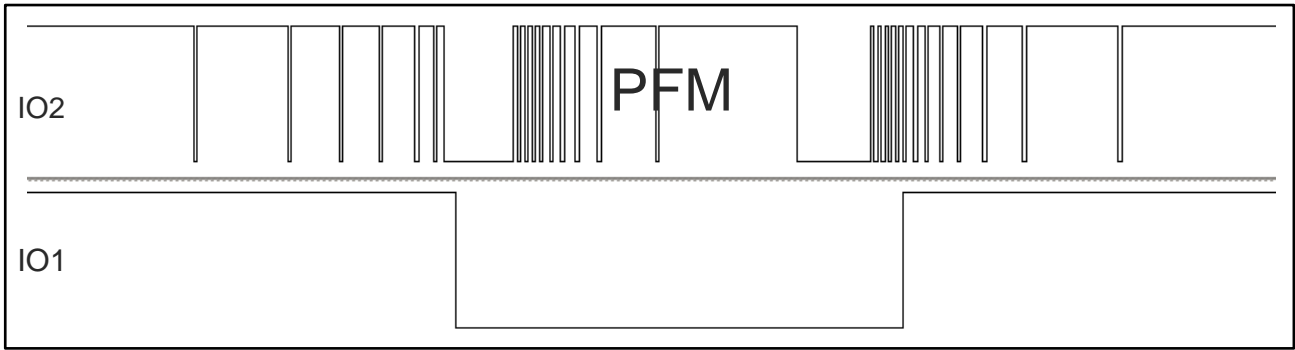

Figure 3.2 Movement (PFM) and activation output

'01' – PWM

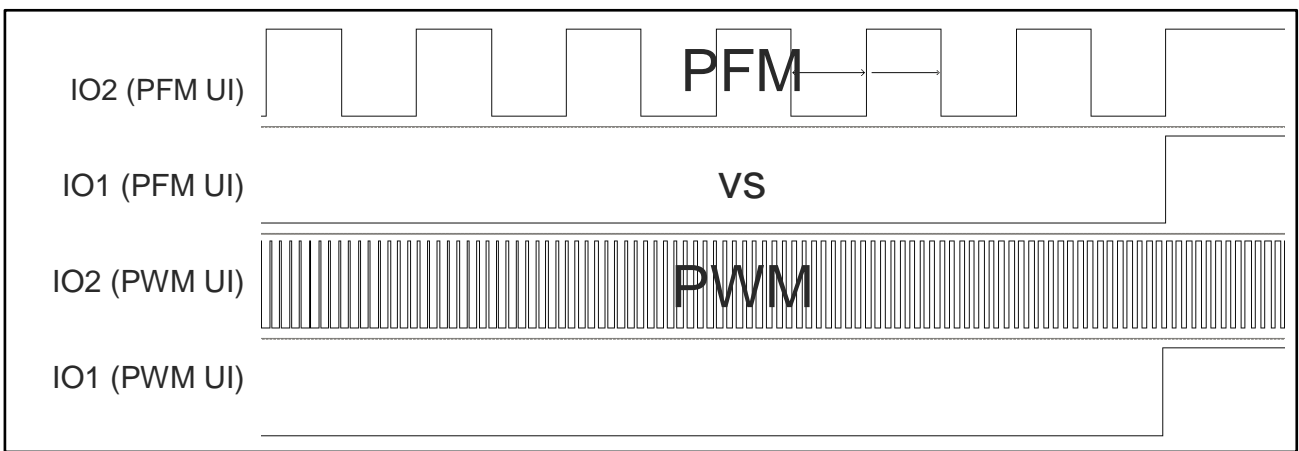

Figure 3.3 PFM movement output (TOP: 15ms period minimum) compared with PWM movement output (BOTTOM: 1ms period)

'10' – Latched (forces output for duration of timer)

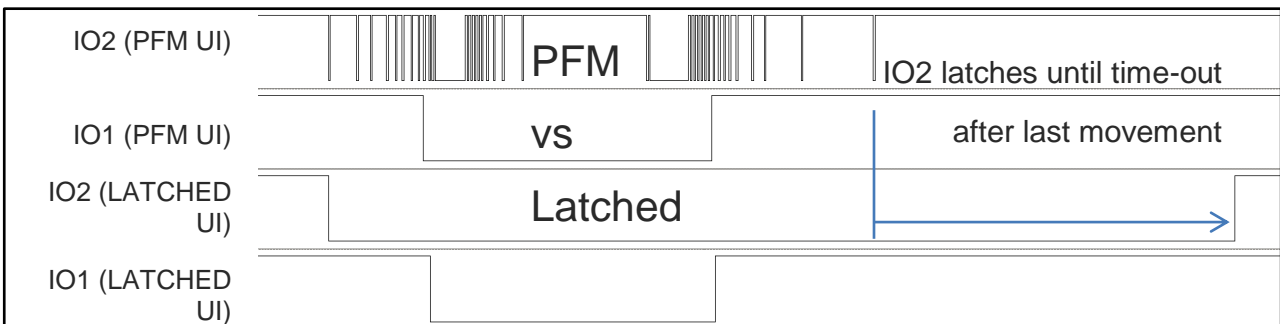

Figure 3.4 PFM movement output (TOP) compared with latched movement output (BOTTOM). Movement output is forced by first movement

'11' – PWM (only active during activation)



3.2.4 Bank 3: Miscellaneous1 – Reserved ALS, sample filter, input control and output PWM

| | |
|--------------|--------------------|
| Bank3: bit 2 | AC filter increase |
|--------------|--------------------|

With the AC filter increase enabled, the reaction time slows with more rapid changes being filtered out. This option is ideal for a system connected to a power supply with increased noise

| | |
|--------------|-------------------------------------------------|
| Bank3: bit 1 | Multifunction Bit (applies only to certain UIs) |
|--------------|-------------------------------------------------|

Output definition: “000” Activation & Movement UI:

The IO1 pin normally only triggering with crossing of the threshold can be configured to output the depth of activation in PWM data. This is ideal for interpreting the specific activation level with a master, or for simply indicating the activation level on an analogue load.

Please note that when enabling this option, the PWM option on the IO2 pin will be disabled (**Bank2: bit 4:3** option ‘01’ will be the same as ‘00’)

Input definition: “010” Movement & Input UI:

By selecting the UI with the IO2 pin defined as an input, this configuration bit will enable the choice of input between the following

‘0’ – The halt charge & reseed option as defined above or

‘1’ – Reduce movement sensitivity for applications that may switch between battery usage and more noisy power supplies for charging and back-up power.

| | |
|--------------|-------------------------------------------------------------------|
| Bank3: bit 0 | Activation output with input reseed & reset (halt charge) feature |
|--------------|-------------------------------------------------------------------|

Extended IO1 definition: “000” Activation & Movement UI / “001” Movement latch output (forced) & Movement UI

With digital outputs enabled the IO1 pin has the option of being an input to “halt charge” / “reseed”. A short pulse ($t > 15\text{ms}$, $t < 25\text{ms}$) will initiate a reseed action ($LTA = \text{counts} - 8$) and a longer pulse ($t > 50\text{ms}$) will enable a lower power mode without sensing. The IQS211 will reset after the longer pulse is released (after a “halt charge” the IC will reset).

3.2.5 Bank 4: Miscellaneous2 – Partial ATI, ATI target and power-on detection

| | |
|--------------|-------------|
| Bank4: bit 2 | Partial ATI |
|--------------|-------------|

Partial ATI may be selected to limit the automatic tuning range of the sensor. This may give more predictable results, especially when the sensor tends to calibrate close to the edges by automatically choosing a certain sensitivity multiplier value. Set this bit and select a specific sensitivity multiplier value in **Base Value (Sensitivity Multiplier in Partial ATI mode)**. A lower sensitivity multiplier value is recommended for light capacitive loads, while higher values for large capacitive loads.

Set this bit if the auto-activation at power-up bit is set (**Bank4: bit 0**). By setting this bit, the auto activation “threshold” is chosen by selecting a sensitivity multiplier value **Base Value (Sensitivity Multiplier in Partial ATI mode)**. A lower sensitivity multiplier value will result in a sensitive threshold, while higher values will give a less sensitive threshold.

| | |
|--------------|------------|
| Bank4: bit 1 | ATI target |
|--------------|------------|



The default target of 768 ensures good performance in various environments. Set this bit when increased activation distance and movement sensitivity is required. The target of 1200 is only recommended for battery powered devices where low SNR ratios are expected.

Movement features are most pronounced and effective when using a high target.

| | |
|--------------|---------------------------------------------------------------------------------------------------------------------------------------------------------------------------|
| Bank4: bit 0 | Auto Activation at power-up when P>7 (absolute capacitance detection method, partial ATI must be enabled, select sensitivity with the “Sensitivity Multiplier”) |
|--------------|---------------------------------------------------------------------------------------------------------------------------------------------------------------------------|

With **(Bank4: bit 2)** set this option allows for absolute capacitance detection at power-up. Use this in devices that require a threshold decision at power-up without the calibration step. Select a “threshold” by adjusting the sensitivity multiplier value in **Base Value (Sensitivity Multiplier in Partial ATI mode)**. A lower sensitivity multiplier value will result in a sensitive “threshold”, while higher values will give a less sensitive “threshold”.

4 I2C operation

The IQS211 may be configured as an I2C device through the user interface selection in Bank2: bits 2:0:

| Bank2: bits 2:0 | Description |
|-----------------|------------------------------------------------------------------------------------------------------------------------------------------------|
| 101 | Normal polling for use on I2C bus |
| 110 | I2C polling with signature pulses at power-up / reset. The clock also has a RDY pulse incorporated before each possible communications window. |
| 111 | The clock also has a RDY pulse incorporated before each possible communications window. The IC will wake-up on I2C bus pin changes. |

4.1 Normal I2C polling (101)

The IQS211 prioritizes doing capacitive conversions. With standard polling the IQS211 will do a conversion and thereafter open the window of maximum 20ms for I2C communications. If the microprocessor sends the correct address in this window, the IQS211 will respond with an ACK. When communications are successful, the window will close and conversions will continue. For optimal sensing, the polling should be repeated often in order to keep the communications window time small.

Use normal polling when placing the IQS211 on a bus with other devices.

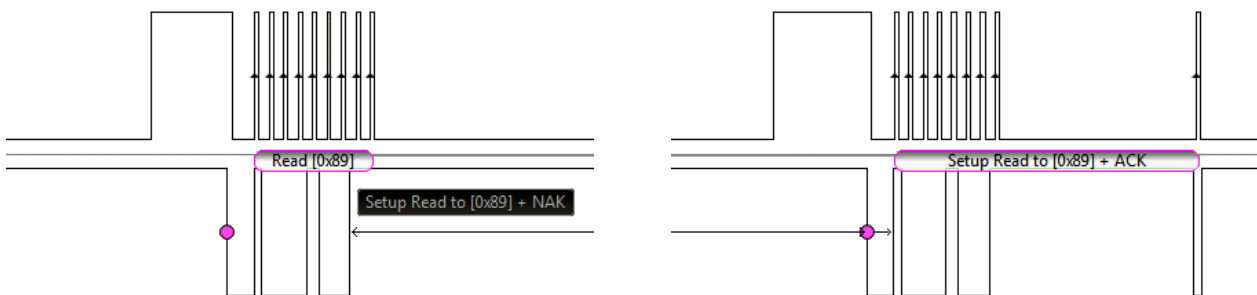

Figure 4.1 I2C polling examples: typical often repeated polling request with NACK (left) along with the successful request with ACK (right)

4.2 I2C polling with reset indication & RDY (110)

This mode is based on I2C, but not I2C compatible. This mode is aimed at solutions that need the flexibility of the register settings but require standalone operation during run-time. The data and clock lines toggle at power-on or reset to indicate that the device requires setup. After changing the settings and more particularly the user interface option, the device will start operating in the required mode.

In this mode the IQS211 is not able to share a bus with other devices. Normal polling may be used, but the master may also monitor the I2C clock line as an indication from the IQS211 that the communications window is open. The clock line therefore serves as a ready line.

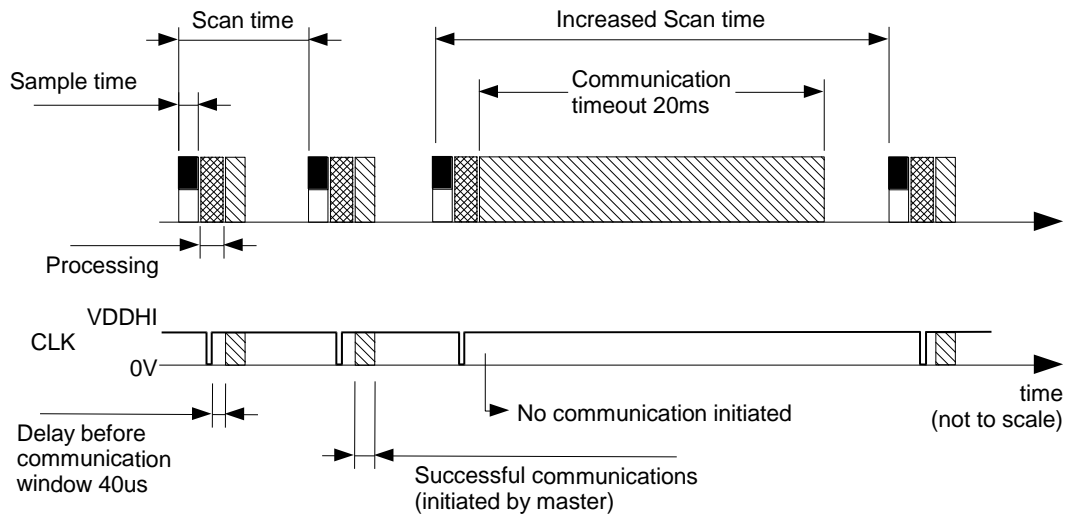

Figure 4.2 How to use RDY signal on clock line

Communications may be initiated at any time from clock low-to-high transition plus 40us until 20ms thereafter, when the communications window closes. Polling should be done within this time window in order to communicate with the device. If no communications are done the window will time out. If communications are completed with a stop command, the window will close and sampling will continue after a sleep period.

***Erata: After changing register 0xC7 (memory map) in this mode, it is required to read any other register in order to activate the chosen user interface (such as a standalone mode) before sending a stop command.**

4.3 I2C polling with RDY on clock and wake-up on pin change (111)

This I2C mode is aimed at applications that require the flexibility of I2C settings, but requires wake-up functionality from the master side. A ready indication is also given on the clock line to enable the master to efficiently handle the available communications window.

The wake-up on pin change prevents this configuration from being used along with other devices on the bus.



4.4 I2C registers

Table 4.1 I2C communications layout

| I2C Communications Layout | | | | | | | | | | | |
|------------------------------|------------------------------------|-----|------------------|----------------------------------------------------------------------------------------------|------------------------------------------------------------------------------------------------------------------------------------|---------------------------------------------------------------|------------------------------------------------------------------------------------------------------------------------------------------------|---------------------------------------------------------------------------------------------------------------------------------------------------------------------------------------------------------------------------------------------------------------------------------------------------------------------------------------------------------------------|------------------------|------------------------------------------------------------------------------------------------------|--------------------------------------------------------------------------------------------------|
| Address/ Command/ Byte | Register name/s | R/W | Default Value | Bit 7 | Bit 6 | Bit 5 | Bit 4 | Bit 3 | Bit 2 | Bit 1 | Bit 0 |
| 00H | PRODUCT_NUM | R | | | | | | | | | |
| 01H | VERSION_NUM | R | | | | | | | | | |
| 10H | SYSFLAGS0 | R/W | | Movement | Movement Constant | PROX | TOUCH | Show Reset | ATI Busy | Filter Halt | LP Active |
| 41H | Movement Value | R | | | | | | | | | |
| 42H | CS_H | R | | | | | | | | | |
| 43H | CS_L | R | | | | | | | | | |
| 83H | LTA_H | R | | | | | | | | | |
| 84H | LTA_L | R | | | | | | | | | |
| 90H | Touch Threshold_H | | | | | | | | | | |
| 91H | Touch Threshold_L | | | | | | | | | | |
| C4H | MULTIPLIERS | R/W | | n/a | n/a | n1 | n0 | p3 | p2 | p1 | p0 |
| C5H | COMPENSATION | R/W | | 0-255 | | | | | | | |
| C6H | PROX_SETTINGS0 | R/W | | Base Value/ SensMult for Partial: 00 – 150/0 01 – 100/1 10 – 200/2 11 – 250/3 | | Reseed | Redo ATI | Active Scan Time 000 – 8ms (normal) 001 - +32ms Sleep 010 - +64ms Sleep 011 - +256ms Sleep | | Idle Scan time 000 – 8ms (normal) 001 - +32ms Sleep 010 - +64ms Sleep 011 - +256ms Sleep | |
| C7H | PROX_SETTINGS1 | R/W | | 0 – Auto reseed is in seconds 1 – Auto reseed is in minutes | If UI type 011: 0- Halt charge/Reseed 1- Reduce sensitivity If UI type 000: 0- Normal 1- PWM touch out | Halt Charge/Reseed on IO1, with IO1 set as output | 00 – Normal (PFM) 01 – PWM 10 – Constant Movement , clears upon no movement timeout 11 – PFM combined with activation output | 000 – Activation(IO1) & Movement(IO2) 001 – Movement Latch(IO1) and Movement (IO2) 010 – Movement(IO1) & Input(IO2) 011 – Touch (IO1), Prox (IO2) 100 – 1Wire (IO1) & Clk (IO2) (only on events) 101 – I2C (polling) no wakeup 110 - I2C with reset indication +RDY toggle on SCL 111 – I2C (polling) + Wakeup + RDY toggle on SCL | | | |
| C8H | PROX_SETTINGS2 | R/W | | 0 – Prox Timeout of 2s 1 – Prox timeout of 20s | n/a | AUTO Activation on start up | n/a | Touch Late Release (50%) | Partial ATI enabled | Auto ATI off | Increase AC filters, increase touch threshold with 10counts, halt with 4 |
| C9H | ATI_TARGET | R/W | | x * 8 = ATI target | | | | | | | |
| CAH | LP_PERIOD | R/W | | x * 16ms = sleep time | | | | | | | |
| CBH | PROX_THRESHOLD | R/W | | | | | | | | | |
| CCH | TOUCH_THRESHOLD | R/W | | | | | | | | | |
| CDH | MOVEMENT_THRESHOLD | R/W | | | | | | | | | |
| CEH | AUTO_RESEED_LIMIT | R/W | | in Seconds or Minutes, based on PROX_SETTINGS1 bit 7. | | | | | | | |

00H Product number

The product number is **0x3D**

01H Version number

The firmware version number is **0x00**

10H SYSFLAGS0

Bit7: Movement – this bit is set with each movement event and reset once the system does not detect movement

Bit6: Movement Latch – this bit is set only when a movement latch option is enabled and a movement is detected. The bit is cleared only when a no-movement time-out occurs. A soft reset operation does not clear this bit.

Bit5: PROX – the prox bit is the same as the LTA filter halt for “freezing” the reference counts. This bit is set and reset based on the proximity/filter halt threshold and is always active independent of the user interface.

Bit4: TOUCH – the touch bit is the main activation output of the system. Any user interface that includes an activation event is based on this bit.



Bit3: Show reset – This bit is written at each hard reset event. Manually clear this bit and monitor for detecting hardware reset events.

Bit2: ATI busy – The ATI busy indicates a period where the operating point of the device is being determined (calibration). Reading count values and status values may be inaccurate in this time.

Bit1: Filter Halt – The filter halt and PROX bit are very similar. Usually they will have the same value. The exception is when a debounced proximity event is not detected while a debounced touch event is detected. In this case the filter halt will trigger, but not the PROX bit.

Bit0: LP active – With any low power mode active in register “CAH”, this bit is set. Low power modes available in register “C6H” do not affect this bit. This bit is set when no interaction leads to a low power state with no proximity or touch events.

41H Movement Value

The 8-bit movement value is an average of movement pulses over a time period. The value indicates intensity of movement over a short period.

42H & 43H Counts (Immediate filtered capacitance)

The counts are directly proportional to capacitance and the system is calibrated to make the counts as sensitive as possible to changes in capacitance for relative measurements

83H & 84H Long term average (LTA)

The LTA is used as reference to compare with counts. The LTA will follow slow environmental changes with temperature, but will freeze once an event is triggered, calling a LTA “filter halt”.

90H & 91H Touch Threshold value

The touch threshold value here is calculated from the chosen value in register “CCH”. The value will indicate at which value the counts will trigger a touch event.

C4H MULTIPLIERS

The multipliers register is a combination of the sensitivity multiplier and compensation multiplier values. These values are determined by the calibration routine and give an indication of the capacitive load on the system.

C5H COMPENSATION

The COMPENSATION is also part of the calibration routine and offers gain to the system.

C6H PROX_SETTINGS0

Bit 7-6: Base value – as described in this here: **Base Value (Sensitivity Multiplier in Partial ATI mode)**.

Bit 5: Reseed – The reseed command will equal the LTA to the counts. When the LTA is inside the boundary set for the chosen target, the reseed will not cause a re-calibration. When the LTA is out of this boundary, an automatic re-calibration will be done.

Bit 4: Redo-ATI – The redo-ATI command will force a recalibration. The bit is automatically cleared after the operation.

Bit 3-2: ACTIVE scan time – as described in this here: **ACTIVATION scan time**

Bit 1-0: IDLE scan time – as described here: **IDLE scan time (proximity/halt scan time)**



C7H PROX_SETTINGS1

Bit 7: Auto reseed time guide – Auto-reseed time guide selection of the value set in register “CEH”. With this bit set the value of “CEH” will be in minutes and with this bit cleared, it will be in seconds.

Bit 6: Multifunction Bit (applies only to certain UIs)

Bit 5: Activation output with input reseed & reset (halt charge) feature

Bit 4-3: Movement output type

Bit 2-0: User interface selection (select function of IO1 and IO2)

C8H PROX_SETTINGS2

Bit 7: PROX/Filter halt time-out definition – With this bit cleared the filter halt is only kept for 2 seconds when no movement is detected during this period. With this bit set the filter halt condition remains for 20seconds when no movement is detected. A movement event will reset this timer. This option is only available in I²C mode.

Bit 5: Auto Activation at power-up when P>7 (absolute capacitance detection method, partial ATI must be enabled, select sensitivity with the “Sensitivity Multiplier”)

Bit 3: Touch late release (50% of touch threshold)

Bit 2: Partial ATI

Bit 1: Auto-ATI off – With this bit set, the ATI algorithm will only execute with a “Redo-ATI” command. A no-movement time-out will execute a simple “reseed” command without the possibility of a recalibration occurring.

Bit 0: AC filter increase

C9H ATI_TARGET

Calibration routines will attempt to get the counts as close as possible to this target count. Although it is possible to reach a 2048 count target, it is recommended to aim for a maximum target of 1600 for the effect of noise and environment on the system.

CAH LP_PERIOD

The low power period refers to the part of the scan period where no communications or sensing is done. This period is indicated as the “sleep time” in Figure 1.12.

CBH PROX_THRESHOLD

The value chosen is a ratio applied to the target and more specifically, the actual count value after aiming for a specific target.

The equation for deriving actual counts of the threshold below the LTA is as follows:

$$P_{TH\ actual} = \frac{LTA \times P_{TH}}{256}$$

As example take $P_{TH} = 4$ with a target of 1200 and actual counts reached = 1180:

$$P_{TH\ actual} = \frac{LTA \times P_{TH}}{256} = \frac{1180 \times 4}{256} = 18\ counts$$

In this case the proximity event will trigger and the LTA filter halt is activated when the counts fall 18 counts below the LTA.

Threshold values are not dynamic and are locked at time of calibration.

**CCH TOUCH_THRESHOLD**

The touch threshold value is determined in the same way as the PROX_THRESHOLD above. When the TOUCH_THRESHOLD is ≥ 15 , the touch is undebounced. Touch flags are set, but streaming counts remain filtered, not indicating the event.

CDH MOVEMENT_THRESHOLD

The movement threshold value is determined in the same way as the PROX_THRESHOLD above. If using the movement feature, this value should be < 25 .

CEH AUTO_RESEED_LIMIT

The automatic reseed time limit may be fine-tuned from:

1 to 255 seconds with C7H bit 7 cleared (always halt with CEH = 0xFF)

1 to 255 minutes with C7H bit 7 set (always halt with CEH = 0xFF)



5 Design Considerations

5.1 Power Supply and PCB Layout

Azoteq IC's provide a high level of on-chip hardware and software noise filtering and ESD protection (refer to application note "[AZD013 – ESD Overview](#)"). Designing PCB's with better noise immunity against EMI, FTB and ESD in mind, it is always advisable to keep the critical noise suppression components like the decoupling capacitors and series resistors in Figure 2.2 as close as possible to the IC. Always maintain a good ground connection and ground pour underneath the IC. For more guidelines please refer to the relevant application notes as mentioned in the next section.

5.2 Design Rules for Harsh EMC Environments

Applicable application notes: AZD013, AZD015, AZD051, and AZD052.

5.3 High Sensitivity

Through patented design and advanced signal processing, the device is able to provide extremely high sensitivity to detect proximity. This enables designs to detect proximity at distances that cannot be equaled by most other products. When the device is used in environments where high levels of noise or floating metal objects exist, a reduced proximity threshold is proposed to ensure reliable functioning of the sensor. The high sensitivity also allows the device to sense through overlay materials with low dielectric constants, such as wood or porous plastics.

For more guidelines on the layout of capacitive sense electrodes, please refer to application note "[AZD008 – Design Guidelines for Touch Pads](#)", available on the Azoteq web page: www.azoteq.com.

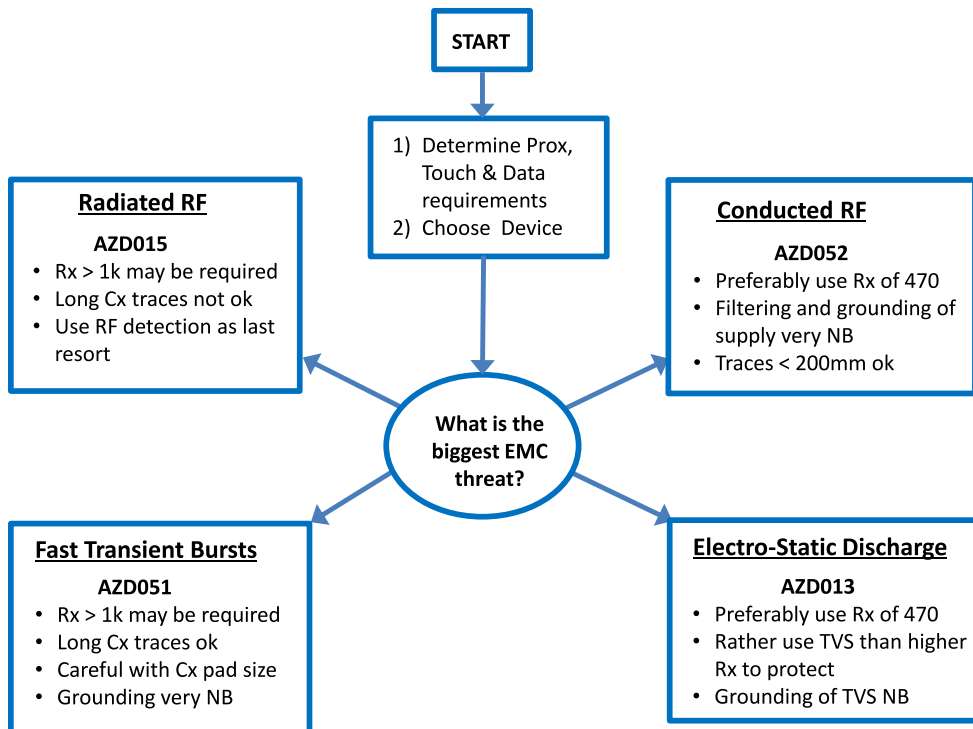



6 Specifications

6.1 Absolute maximum ratings

The following absolute maximum parameters are specified for the device:

Exceeding these maximum specifications may cause damage to the device.

- Operating temperature -40°C to 85°C
- Supply Voltage (VDDHI – VSS) 3.6V
- Maximum pin voltage VDDHI + 0.5V (may not exceed VDDHI max)
- Maximum continuous current (for specific Pins) 10mA
- Minimum pin voltage VSS – 0.5V
- Minimum power-on slope 100V/s
- ESD protection ±8kV (Human body model)
- Package Moisture Sensitivity Level (MSL) 1

Table 6.1 IQS211 General Operating Conditions

| DESCRIPTION | Conditions | PARAMETER | MIN | TYP | MAX | UNIT |
|------------------------------|-------------------------------|--------------------------|------|------|------|------|
| Supply voltage | | V _{DDHI} | 1.8 | 3.3V | 3.6 | V |
| Internal regulator output | 1.8 ≤ V _{DDHI} ≤ 3.6 | V _{REG} | 1.62 | 1.7 | 1.79 | V |
| Default Operating Current | 3.3V, Scan time = 9 | I _{IQS211DP} | | 77 | 88 | μA |
| Low Power Example Setting 1* | 3.3V, Scan time = 32 | I _{IQS211LP32} | | 23 | | μA |
| Low Power Example Setting 2* | 3.3V, Scan time = 64 | I _{IQS211LP64} | | 9.5 | | μA |
| Low Power Example Setting 3* | 3.3V, Scan time = 128 | I _{IQS211LP128} | | 5.5 | | μA |
| Low Power Example Setting 4* | 3.3V, Scan time = 256 | I _{IQS211LP256} | | 3.5 | 3.9 | μA |

*Scan time in ms

Table 6.2 Start-up and shut-down slope Characteristics

| DESCRIPTION | Conditions | PARAMETER | MIN | MAX | UNIT |
|------------------|----------------------------------------|-----------|------|-----|------|
| Power On Reset | V _{DDHI} Slope ≥ 100V/s @25°C | POR | 1.2 | 1.6 | V |
| Brown Out Detect | V _{DDHI} Slope ≥ 100V/s @25°C | BOD | 1.15 | 1.6 | V |



Table 6.3 Input signal response characteristics (IO1/IO2)

| DESCRIPTION | MIN | TYP | MAX | UNIT |
|-------------------------------------------|-----|-----|-----|------|
| Reseed function | 15 | 20 | 25 | ms |
| Halt charge / Reduce sensitivity function | 50 | n/a | n/a | ms |

Table 6.4 Communications timing characteristics

| DESCRIPTION | MIN | TYP | MAX | UNIT |
|----------------------------|-----|-----|-----|------|
| t _{RDY} | - | 40 | - | µs |
| t _{comms_timeout} | - | 20 | - | ms |

Table 6.5 Digital input trigger levels

| DESCRIPTION | Conditions | PARAMETER | MIN | TYPICAL | MAX | UNIT |
|--------------------|------------|--------------------------|------|---------|------|------|
| All digital inputs | VDD = 3.3V | Input low level voltage | 1.19 | 1.3 | 1.3 | V |
| All digital inputs | VDD = 1.8V | Input low level voltage | 0.54 | 0.6 | 0.76 | V |
| All digital inputs | VDD = 1.8V | Input high level voltage | 0.9 | 1.0 | 1.2 | V |
| All digital inputs | VDD = 3.3V | Input high level voltage | 1.90 | 2.1 | 2.20 | V |

7 Package information

7.1 TSOT23-6

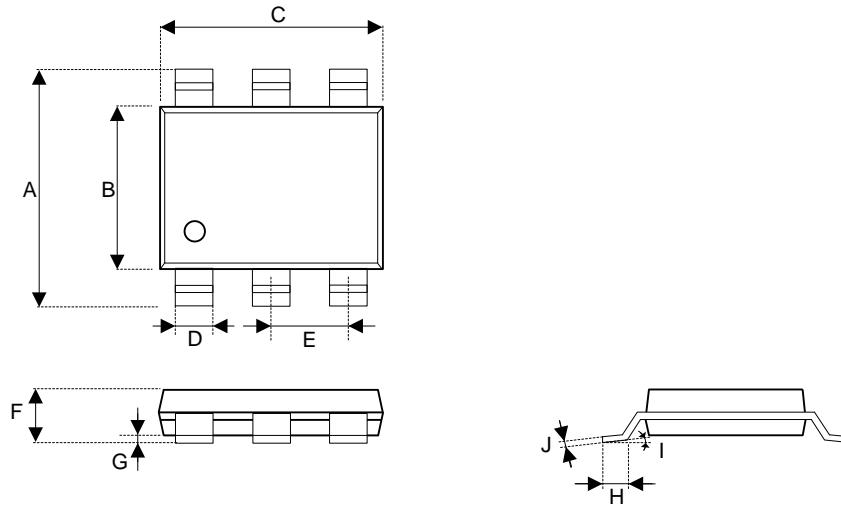

Figure 7.1 TSOT23-6 Packagingⁱ

Table 7.1 TSOT23-6 Dimensions

| Dimension | Min (mm) | Max (mm) |
|-----------|------------|----------|
| A | 2.60 | 3.00 |
| B | 1.50 | 1.70 |
| C | 2.80 | 3.00 |
| D | 0.30 | 0.50 |
| E | 0.95 Basic | |
| F | 0.84 | 1.00 |
| G | 0.00 | 0.10 |
| H | 0.30 | 0.50 |
| I | 0° | 8° |
| J | 0.03 | 0.20 |
| | | |

ⁱ Drawing not on Scale



7.2 Device packaging convention

7.2.1 Top

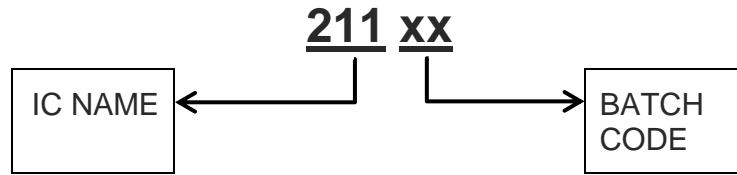

| | |
|---------|-----|
| IC name | 211 |
| Batch | xx |

7.2.2 Bottom

No bottom marking present

7.3 MSL Level

Moisture Sensitivity Level (MSL) relates to the packaging and handling precautions for some semiconductors. The MSL is an electronic standard for the time period in which a moisture sensitive device can be exposed to ambient room conditions (approximately 30°C/85%RH see J-STD033C for more info) before reflow occur.

| Package | Level (duration) |
|----------|-------------------------------------------------------------------------------------------------|
| TSOT23-6 | MSL 1 (Unlimited at ≤30 °C/85% RH) Reflow profile peak temperature < 260 °C for < 30 seconds |



8 Ordering and Part-number Information

8.1 Ordering Information

Please check stock availability with your local distributor.

| | | | |
|-----------------------|------------|---|---------------------------------------------------------------------------------------------------------|
| CONFIGURATION | zzz zzz zz | = | IC configuration (hexadecimal) Default 000 000 00 (other configurations available on request) |
| PACKAGE TYPE | TS | = | TSOT23-6 package |
| BULK PACKAGING | R | = | Reel (3000pcs/reel) – MOQ = 3000pcs MOQ = 1 reel (orders shipped as full reels) |

8.2 Device Numbering Convention

| | | | |
|--------------------------|-------|---|----------------------------|
| REVISION | x | = | IC Revision Number |
| TEMPERATURE RANGE | t | = | -40°C to 85°C (Industrial) |
| DATE CODE | P | = | Internal use |
| | WWYY= | = | Batch number |

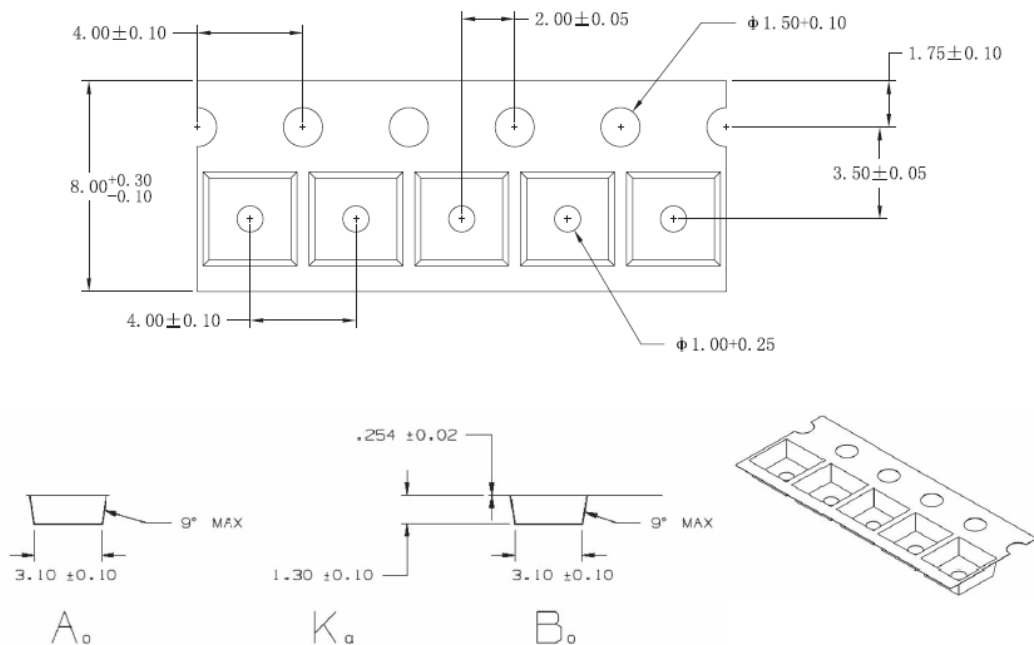

NOTE:
 1. Material is PC;
 2. Material : 3000.

Figure 8.1 TSOT23-6 Tape Specification



9 Revision History

| Revision Number | Description | Date of issue |
|-----------------|-------------------------------------------------------------------------------------------------------------------------------------------------------------------------------|------------------|
| V0.1 | Draft revision | 17 December 2013 |
| V0.3 | Parameters updated, I2C information added | 30 January 2014 |
| V0.4 | OTP options updated, pin descriptions updated | 18 June 2014 |
| V0.5 | Scan times updated throughout document | 1 August 2014 |
| V0.6 | I ² C memory map updated | 4 September 2014 |
| V1.0 | Low power scan times corrected throughout Input signal characteristics detail added User interface descriptions added I ² C Memory map descriptions added | 25 November 2014 |
| V1.1 | Minor update: Auto reseed limit – 0xFF is always halt Using COMPENSATION and MULTIPLIER terms | 23 January 2015 |
| V1.2 | Contact and patent information updated on last page. Communications specification updated for user interface with interrupt on clock line | 10 April 2015 |
| V1.3 | Device package top marking detail added | 13 November 2015 |

**Appendix A Contact Information**

| | USA | Asia | South Africa |
|-------------------------|---------------------------------------------------------------------|-------------------------------------------------------------------------------------|------------------------------------------------------|
| Physical Address | 6507 Jester Blvd Bldg 5, suite 510G Austin TX 78750 USA | Rm2125, Glittery City Shennan Rd Futian District Shenzhen, 518033 China | 109 Main Street Paarl 7646 South Africa |
| Postal Address | 6507 Jester Blvd Bldg 5, suite 510G Austin TX 78750 USA | Rm2125, Glittery City Shennan Rd Futian District Shenzhen, 518033 China | PO Box 3534 Paarl 7620 South Africa |
| Tel | +1 512 538 1995 | +86 755 8303 5294 ext 808 | +27 21 863 0033 |
| Fax | +1 512 672 8442 | | +27 21 863 1512 |
| Email | kobusm@azoteq.com | linayu@azoteq.com.cn | info@azoteq.com |

Please visit www.azoteq.com for a list of distributors and worldwide representation.

The following patents relate to the device or usage of the device: US 6,249,089 B1; US 6,621,225 B2; US 6,650,066 B2; US 6,952,084 B2; US 6,984,900 B1; US 7,084,526 B2; US 7,084,531 B2; US 7,265,494 B2; US 7,291,940 B2; US 7,329,970 B2; US 7,336,037 B2; US 7,443,101 B2; US 7,466,040 B2; US 7,498,749 B2; US 7,528,508 B2; US 7,755,219 B2; US 7,772,781 B2; US 7,781,980 B2; US 7,915,765 B2; US 7,994,726 B2; US 8,035,623 B2; US RE43,606 E; US 8,288,952 B2; US 8,395,395 B2; US 8,531,120 B2; US 8,659,306 B2; US 8,823,273 B2 B2; EP 1 120 018 B2; EP 1 206 168 B1; EP 1 308 913 B1; EP 1 530 178 A1; EP 2 351 220 B1; EP 2 559 164 B1; CN 1330853; CN 1783573; AUS 761094; HK 104 1401

IQ Switch[®], SwipeSwitch[™], ProxSense[®], LightSense[™], AirButton[™] and the logo are trademarks of Azoteq.

The information in this Datasheet is believed to be accurate at the time of publication. Azoteq uses reasonable effort to maintain the information up-to-date and accurate, but does not warrant the accuracy, completeness or reliability of the information contained herein. All content and information are provided on an "as is" basis only, without any representations or warranties, express or implied, of any kind, including representations about the suitability of these products or information for any purpose. Azoteq disclaims all warranties and conditions with regard to these products and information, including but not limited to all implied warranties and conditions of merchantability, fitness for a particular purpose, title and non-infringement of any third party intellectual property rights. Azoteq assumes no liability for any damages or injury arising from any use of the information or the product or caused by, without limitation, failure of performance, error, omission, interruption, defect, delay in operation or transmission, even if Azoteq has been advised of the possibility of such damages. The applications mentioned herein are used solely for the purpose of illustration and Azoteq makes no warranty or representation that such applications will be suitable without further modification, nor recommends the use of its products for application that may present a risk to human life due to malfunction or otherwise. Azoteq products are not authorized for use as critical components in life support devices or systems. No licenses to patents are granted, implicitly, express or implied, by estoppel or otherwise, under any intellectual property rights. In the event that any of the abovementioned limitations or exclusions does not apply, it is agreed that Azoteq's total liability for all losses, damages and causes of action (in contract, tort (including without limitation, negligence) or otherwise) will not exceed the amount already paid by the customer for the products. Azoteq reserves the right to alter its products, to make corrections, deletions, modifications, enhancements, improvements and other changes to the content and information, its products, programs and services at any time or to move or discontinue any contents, products, programs or services without prior notification. For the most up-to-date information and binding Terms and Conditions please refer to www.azoteq.com.

WWW.AZOTEQ.COM

info@azoteq.com