

OPERATIONAL AMPLIFIER

IL9002 / IL9002A

Microcircuit IL9002, IL9002A is essentially the precision operational amplifier with the small bias voltage and the high voltage gain coefficient.

Microcircuit ensures the high values of the parameter stability on time and temperature in the range from - 10 to + 70°C.

As per the structure and the performed functions, the developed microcircuit IL9002N, IL9002AN complies with the analogue OP-07 by Precision Monolithic.

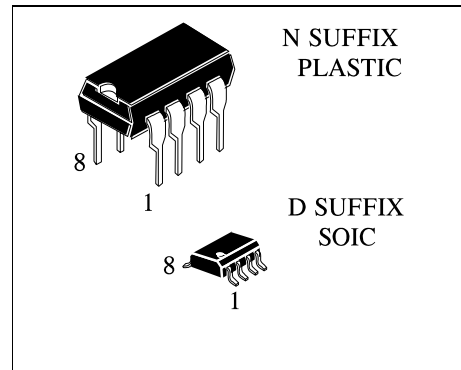

FEATURES

- EXTREMELY LOW OFFSET : 250 μ V MAX
- LOW INPUT BIAS CURRENT : 14nA
- LOW V_{io} DRIFT : 0.5mV/°C
- SUPPLY VOLTAGE RANGE : \pm 13V to \pm 18V

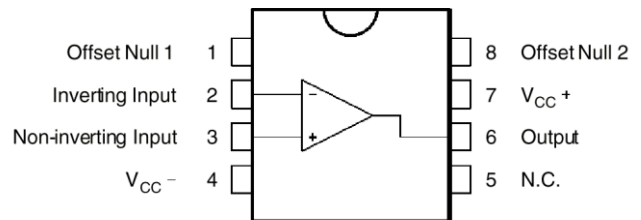

Symbol	Parameter	Value	Unit
V _{cc}	Supply Voltage	\pm 15	V
V _d	Differential Input Voltage	\pm 5	V
V _i	Input Voltage	\pm 10	V
T _{oper}	Operating Temperature	-10 to +70	°C

Pin Description

Pin #	Symbol	Function
01	OFFSET 1	Balance input 1
02	IN-	Inverse input
03	IN+	Non-inverse input
04	V _{CC} -	Supply pin from the negative supply source
05	NC	Vacant pin
06	OUT	Output
07	V _{CC} +	Supply pin from the positive supply source
08	OFFSET 2	Balance input 2

ELECTRICAL CHARACTERISTICS

Parameter Description, Unit of Measurement	Symbol	Norm				Measurement Mode		Temperature °C
		IL9002		IL9002A		V _{CC} , V	R _L , kOhm	
		Min	Max	Min	Max			
Maximum output voltage, V	V _{Omax}	±12	-	±12	-	±15	2.0	
		±10.5		±10.5		±13.5		
		±1.3		±1.3		±3		
Input voltage of zero bias, mcV	V _{IO}	-	±25	-	±75	±15	25±5	
			±55		±105	±16.5		
			±120		±120	±3		
Bias input current, nA	I _{IB}	-	±2	-	±3	±15	25±5	
			±2.5		±4	±16.5		
			±10		±10	±3		
Difference of input currents, nA	I _{IO}	-	±2	-	±2.8	±15	25±5	
			±2.5		±3.5	±16.5		
			±10		±10	±3		
Consumption current, mA	I _{CC}	-	4.0	-	4.0	±15	25±5	
			4.5		4.5	±16.5		
			4.0		4.0	±3		
Voltage gain coefficient, V/mV	A _V	300	-	200	-	±15	25±5	
		100		100		±3		
Maximum synphase input voltage, V	V _{ICmax}	±13	-	±13	-	±15	2.0	
		±1		±1		±3		
Attenuation coefficient of synphase input voltages, dB	K _{CMR}	110	-	110	-	±15	25±5	
		100		100		±3		
Coefficient of power supply sources unstability influence on zero bias voltage, dB	K _{SVR}	100	-	100	-	±15	25±5	
		85		85		±3		

APPLICATION

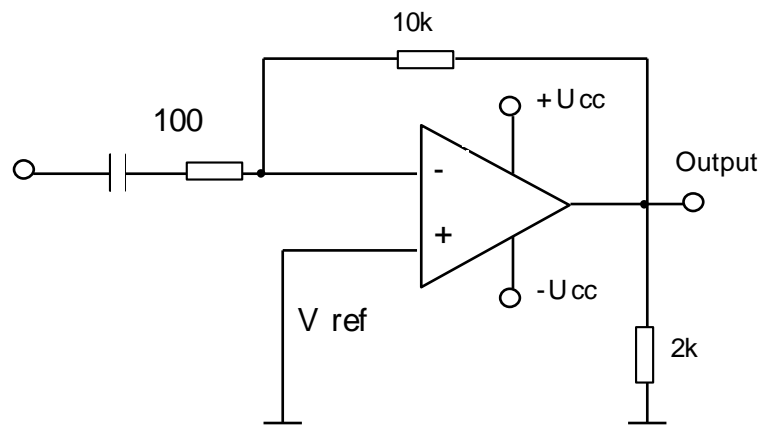

PACKAGE DIMENSIONS

**N SUFFIX PLASTIC DIP
(MS - 001BA)**

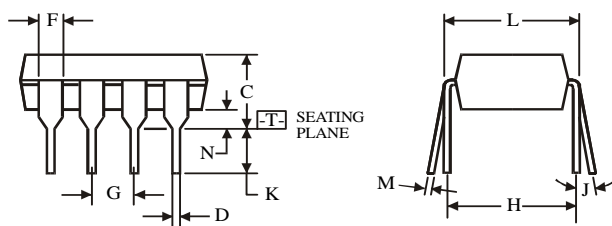
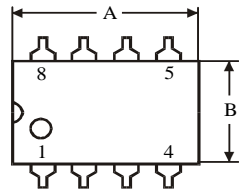
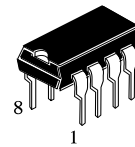

$\oplus 0.25 (0.010) \text{M} \text{T}$

Symbol	Dimension, mm	
	MIN	MAX
A	8.51	10.16
B	6.1	7.11
C		5.33
D	0.36	0.56
F	1.14	1.78
G	2.54	
H	7.62	
J	0°	10°
K	2.92	3.81
L	7.62	8.26
M	0.2	0.36
N	0.38	

NOTES:

- Dimensions "A", "B" do not include mold flash or protrusions.
Maximum mold flash or protrusions 0.25 mm (0.010) per side.

**D SUFFIX SOIC
(MS - 012AA)**

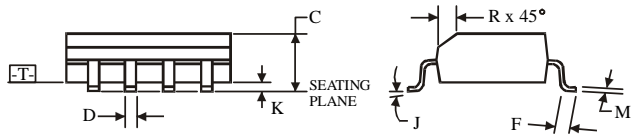
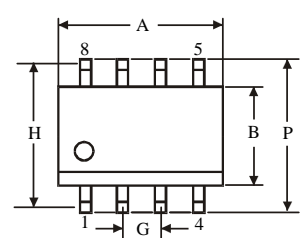
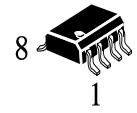

$\oplus 0.25 (0.010) \text{M} \text{T} | \text{C} \text{M}$

Symbol	Dimension, mm	
	MIN	MAX
A	4.8	5
B	3.8	4
C	1.35	1.75
D	0.33	0.51
F	0.4	1.27
G	1.27	
H	5.72	
J	0°	8°
K	0.1	0.25
M	0.19	0.25
P	5.8	6.2
R	0.25	0.5

NOTES:

- Dimensions A and B do not include mold flash or protrusion.
- Maximum mold flash or protrusion 0.15 mm (0.006) per side
for A; for B - 0.25 mm (0.010) per side.