

PRELIMINARY

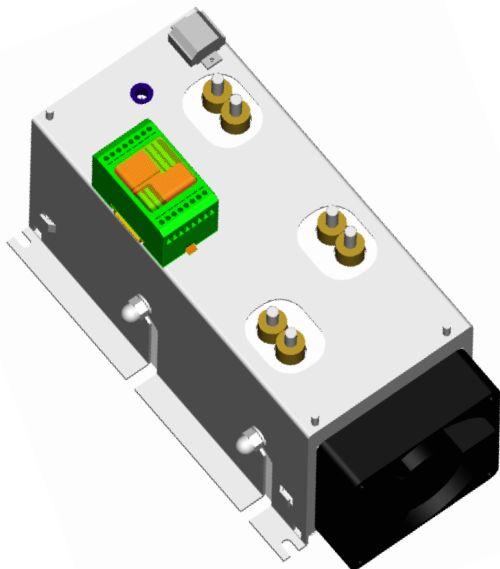

**GEM_027, _030, _033, _034
FAMILY**

Green Power Easy Module®

Features:

- ▶ Electrically insulated metal frame
- ▶ 3000 V_{RMS} Insulation
- ▶ High reliability
- ▶ Modular approach
- ▶ Broad choice of circuit configurations
- ▶ Fully customizable
- ▶ Cost effective solution
- ▶ Suitable for heavy duty applications
- ▶ Line voltage range up to 690V_{RMS}

Description

This new family of high power modules brings to the high power applications the same compactness, ease of use and scalability of the lower power semiconductor modules. In addition to these typical features (i.e. standard dimensions, electrical insulation, various circuit types, etc.) the new *Green Power Easy Module (GEM)* family includes many features that simplify their adoption allowing the end users to focus on their core business. These features include:

- embedded air cooling system (heatsink and fan)
- optimised snubber circuits
- pulse transformer modules
- ducted heat flow.

The GEM family can be used for most of the converter circuits like single and three phase bridges, AC-switches, motor brakes, double wye rectifiers, current source inverters, etc.. Their application range covers all low and high line voltage applications (up to 690V_{RMS}) such as: electroplating, motor drive, induction heating, welding, temperature control, electrolysis, UPS, etc.

Maximum Ratings

Parameters	GEM_027	GEM_030	GEM_033	GEM_034	Conditions	Units
I _{T(AV)}	270	300	330	340	180° cond., half sine, T _A =40°C	A
I _{T(RMS)}	610	680	740	770	as AC-switch, T _A =40°C	A
I _{TSM}	8.5	11	12	15	50Hz, T _J =T _{J(MAX)} , V _R =0V	kA
I _{TSM}	8.95	11.65	12.7	15.9	60Hz, T _J =T _{J(MAX)} , V _R =0V	kA
i ² _t	361	605	720	1125	50Hz, T _J =T _{J(MAX)} , V _R =0V	kA ² s
i ² _t	329	551	656	1025	60Hz, T _J =T _{J(MAX)} , V _R =0V	kA ² s
V _{RRM} V _{DRM}	up to 1600	2200	up to 1600	up to 400	T _J =T _{J(MAX)}	V
T _{J(MAX)}	125	125	125	125		°C

Voltage Ratings

Part Number	Voltage Code	V_{RRM} V_{DRM} maximum repetitive reverse and off-state blocking voltage V	I_{DRM} I_{RRM} max @125°C mA	$V_{L(RMS)}$ maximum suggested line RMS voltage V
GEM_034	04	400	50	110
GEM_027 GEM_033	12 16	1200 1600	50	400 500
GEM_030	22	2200	50	700

Voltage Ratings

Parameters	GEM_027	GEM_030	GEM_033	GEM_034	Conditions	Units
$V_{T(TO)}$ - Threshold voltage	0.9	1.1	0.933	0.87	$T_J=T_{JMAX}$	V
r_t - Slope resistance	0.65	0.552	0.302	0.238	$T_J=T_{JMAX}$	mΩ
I_H - Maximum holding current	600	300	150	600	$T_J=25^\circ\text{C}$	mA
I_L - Typical latching current	1000	700	300	1000	$T_J=25^\circ\text{C}$	mA
P_{MAX} - Maximum power losses					$T_A=40^\circ\text{C}$	W

Triggering Characteristics

Parameters	GEM_027	GEM_030	GEM_033	GEM_034	Conditions	Units
V_{GT} - Gate trigger voltage	3	3.5	2.5	3.5	$T_J=25^\circ\text{C}$, $V_D=5\text{V}$	V
I_{GT} - Gate trigger current	200	250	250	190	$T_J=25^\circ\text{C}$, $V_D=5\text{V}$	mA
P_{GM} - Peak gate power	100	150	100	100	Pulse width= 100μs	W
$P_{G(AV)}$ - Avg. gate power dissip.	2	2	2	2		W
I_{FGM} - Peak gate current	3	10	10	3		A
V_{FGM} - Peak gate voltage (fwd.)	20	30	12	20		V
V_{RGM} - Peak gate voltage (rev.)	5	5	3	5		V

Switching Characteristics

Parameters	GEM_027	GEM_030	GEM_033	GEM_034	Conditions	Units
di/dt - Crit. rate of rise of on-state current	200	200	200	200	$T_J=T_{JMAX}$	A/μs
dv/dt - Crit. rate of rise of off-state voltage	500	500	1000	500	$T_J=T_{JMAX}$	V/μs
t_q - Turn-off time	200	200	300	200	$T_J=T_{JMAX}$, $I_T=1000\text{A}$, $di/dt=20\text{A}/\mu\text{s}$, $V_R=50\text{V}$, $V_D=67\%V_{DRM}$, $dV/dt=20\text{V}/\mu\text{s}$	μs

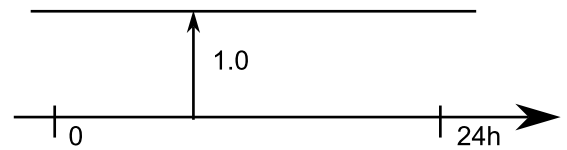
Maximum IEC class 1 currents for typical circuit types

Circuit Type	GEM_027	GEM_030	GEM_033	GEM_034	Conditions	Units
AC switch	610	680	740	770	dealy angle=0, $T_A=40^\circ\text{C}$	A
Center Tap					dealy angle=0, $T_A=40^\circ\text{C}$	A
Two pulse bridge					dealy angle=0, $T_A=40^\circ\text{C}$	A
Six pulse bridge	770	880	960	1000	dealy angle=0, $T_A=40^\circ\text{C}$	A
Double star with I.P. transformer				2000	dealy angle=0, $T_A=40^\circ\text{C}$	A

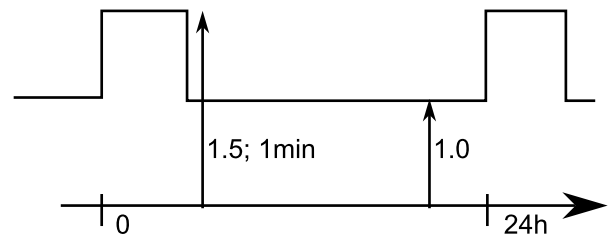

Maximum IEC class 2 currents for typical circuit types

Circuit Type	GEM_027	GEM_030	GEM_033	GEM_034	Conditions	Units
AC switch					dealy angle=0, $T_A=40^\circ\text{C}$	A
Center Tap					dealy angle=0, $T_A=40^\circ\text{C}$	A
Two pulse bridge					dealy angle=0, $T_A=40^\circ\text{C}$	A
Six pulse bridge					dealy angle=0, $T_A=40^\circ\text{C}$	A
Double star with I.P. transformer					dealy angle=0, $T_A=40^\circ\text{C}$	A

Mechanical Characteristics

Parameters	GEM_027	GEM_030	GEM_033	GEM_034	Conditions	Units
T_J - Junction operating temp.	125	125	125	125		$^\circ\text{C}$
T_{STG} - Storage temperature	-40 - +70	-40 - +70	-40 - +70	-40 - +70		$^\circ\text{C}$
R_{thJA} - Maximum thermal resistance junction to ambient					DC operation	$^\circ\text{C/W}$
T Mounting GEM to panel	7	7	7	7	M6 mounting screws	Nm
torque $\pm 10\%$ Busbar to GEM	14	14	14	14	M8 mounting screws	Nm
wt - approximate weight	11	11	11	11	with VFBP options	kg

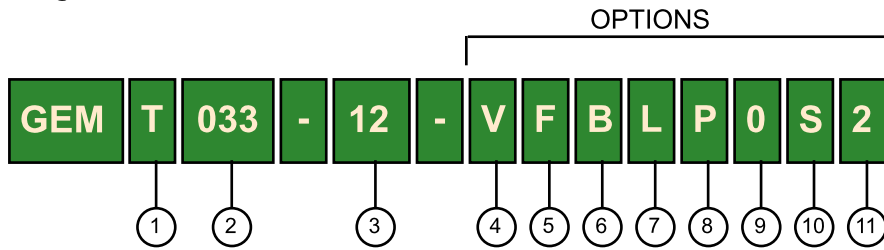
Ordering Information



- ① Circuit configuration
- ② GEM average current / 10
- ③ GEM blocking voltage/ 100
- ④ 0= No Fan; V= With fan
- ⑤ 0= No fuse; F= With fuse protection
- ⑥ 0= No busbar; B= With standard copper busbars at terminals 1, 2, 3 (see drawings)*
- ⑦ 0= No anti-parallel busbar; L= L-shaped anti-parallel busbar;
- ⑧ 0= No pulse transformer; P=With pulse transformer**
- ⑨ 0= No cooling alarm available on this module;
- ⑩ 0= No device short alarm; S=With device short alarm
- ⑪ 0= No snubber, 1= One snubber, 2= Two snubbers

** If option L is requested only the busbar connection at terminal number 1 will be present

** Pulse transformer GT001(dual) or GT0002(single) depending on the circuit configuration for pulse transformer characteristics see their respective datasheet

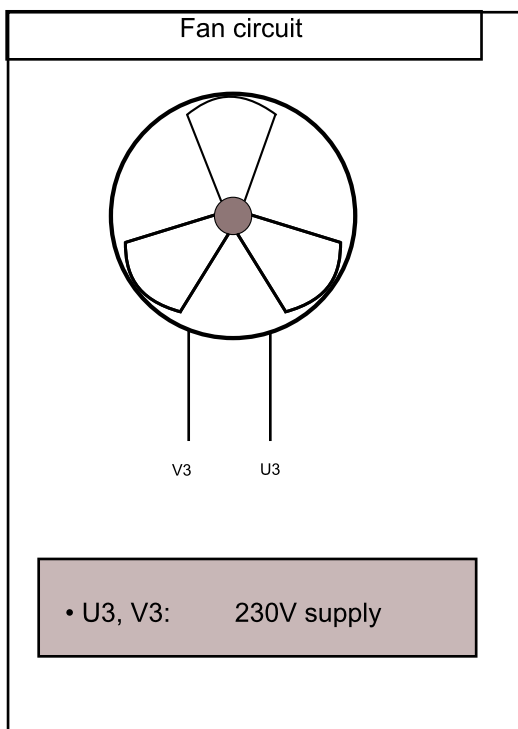

Circuit Configurations

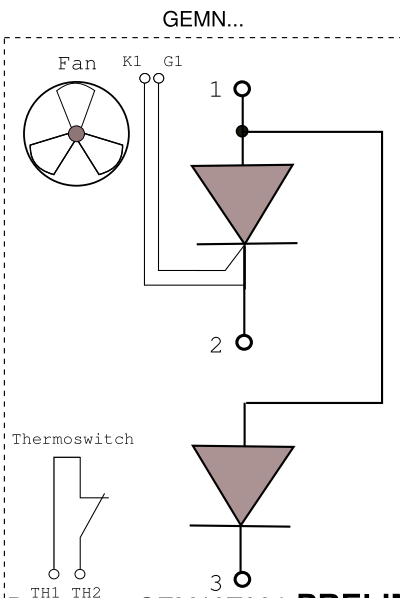
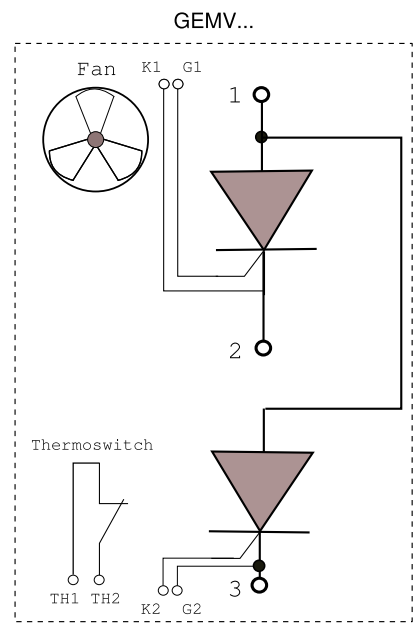
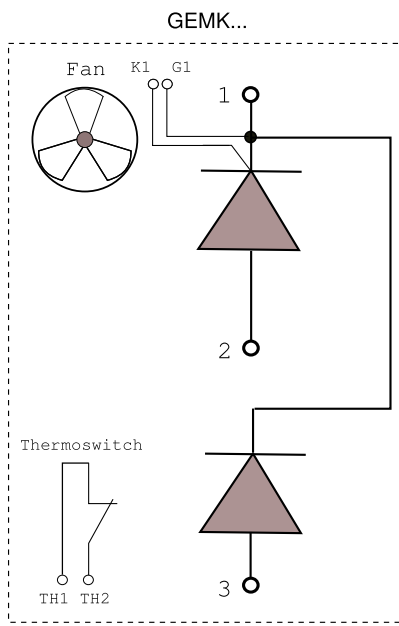
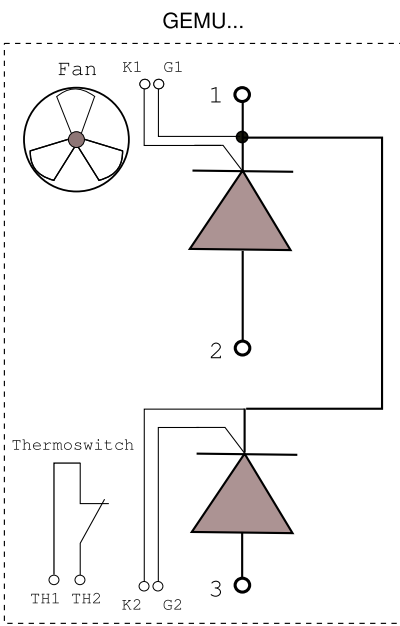
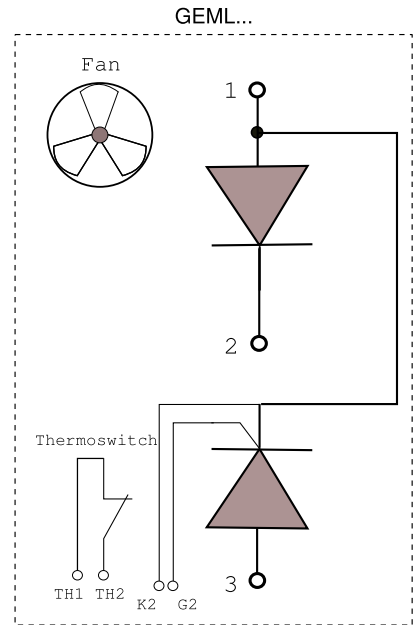
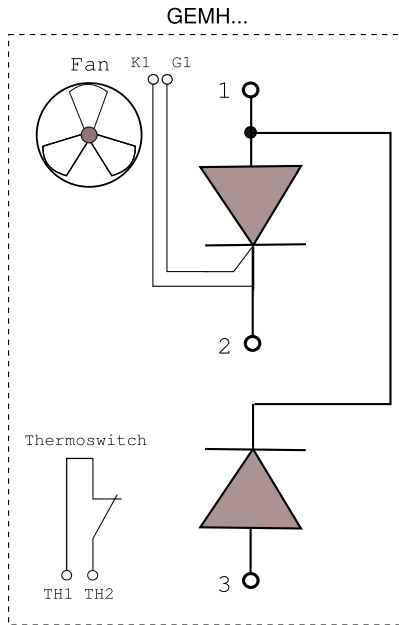
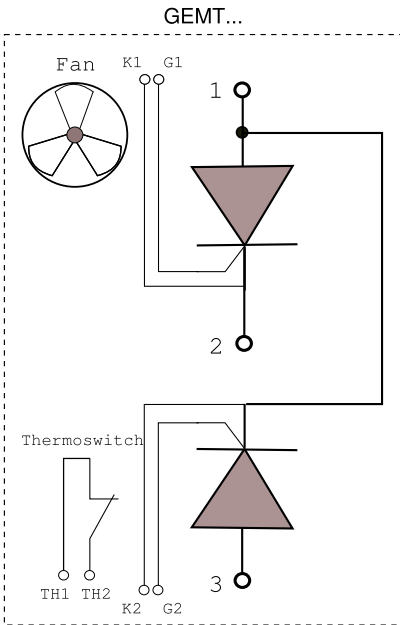

Cooling unit characteristics

Supply voltage: 230V
 Supply freq.: 50-60 Hz
 Supply current: 0.67 A
 Noise: 61dB

Thermoswitch characteristics

Contact type: normally closed
 Switch temp.: 90°C
 Insulation: 2500 V_{DC}

Mechanical Drawings

The drawing shows the version without optional busbars and fuses. In the drawing are present options P (pulse transformer) and V (fan).

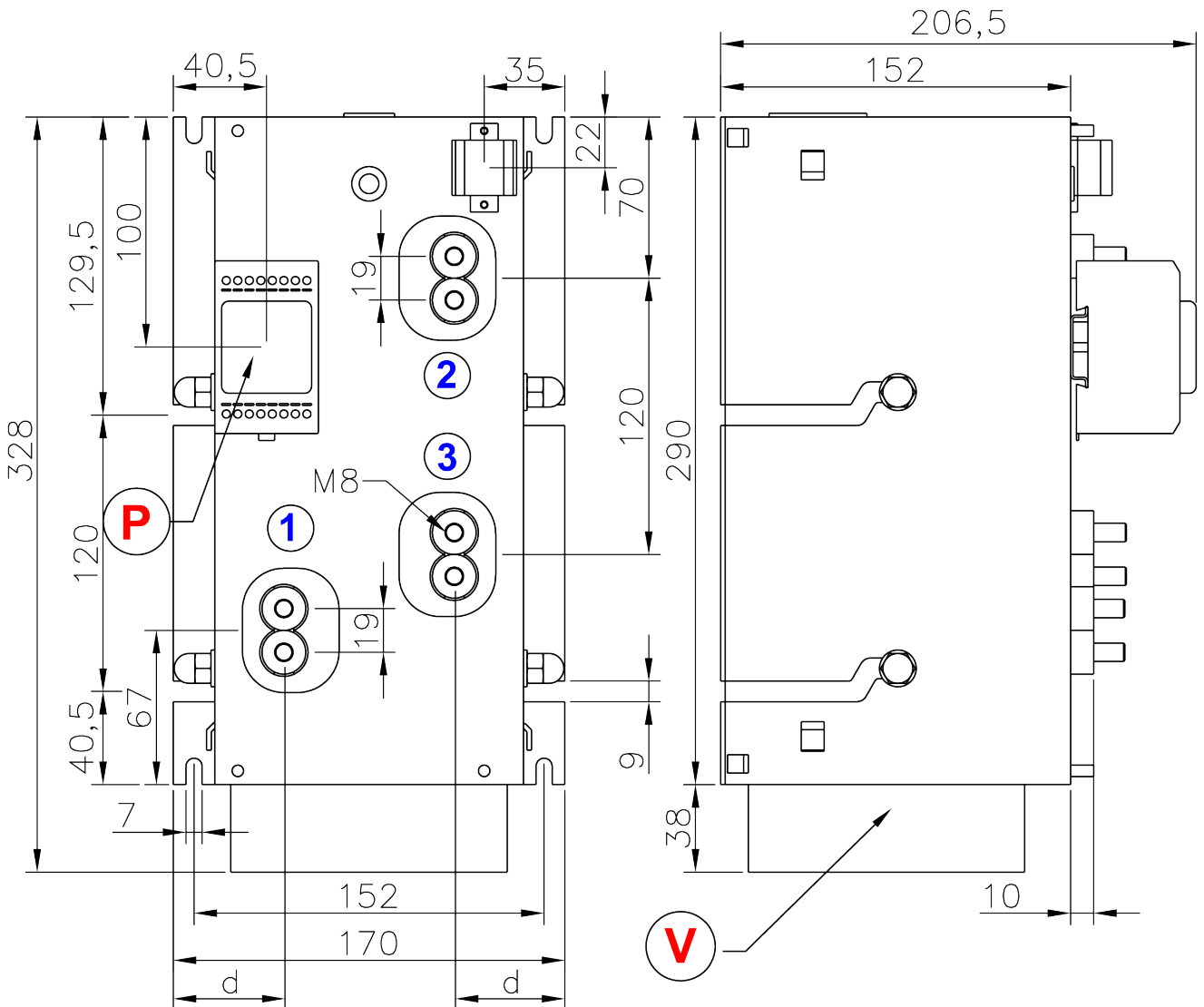

All dimensions are in mm.

Mechanical Drawings

The drawing shows the version with optional busbars (B option) and fuses (F option). In the drawing are also present options P (pulse transformer) and V (fan) .

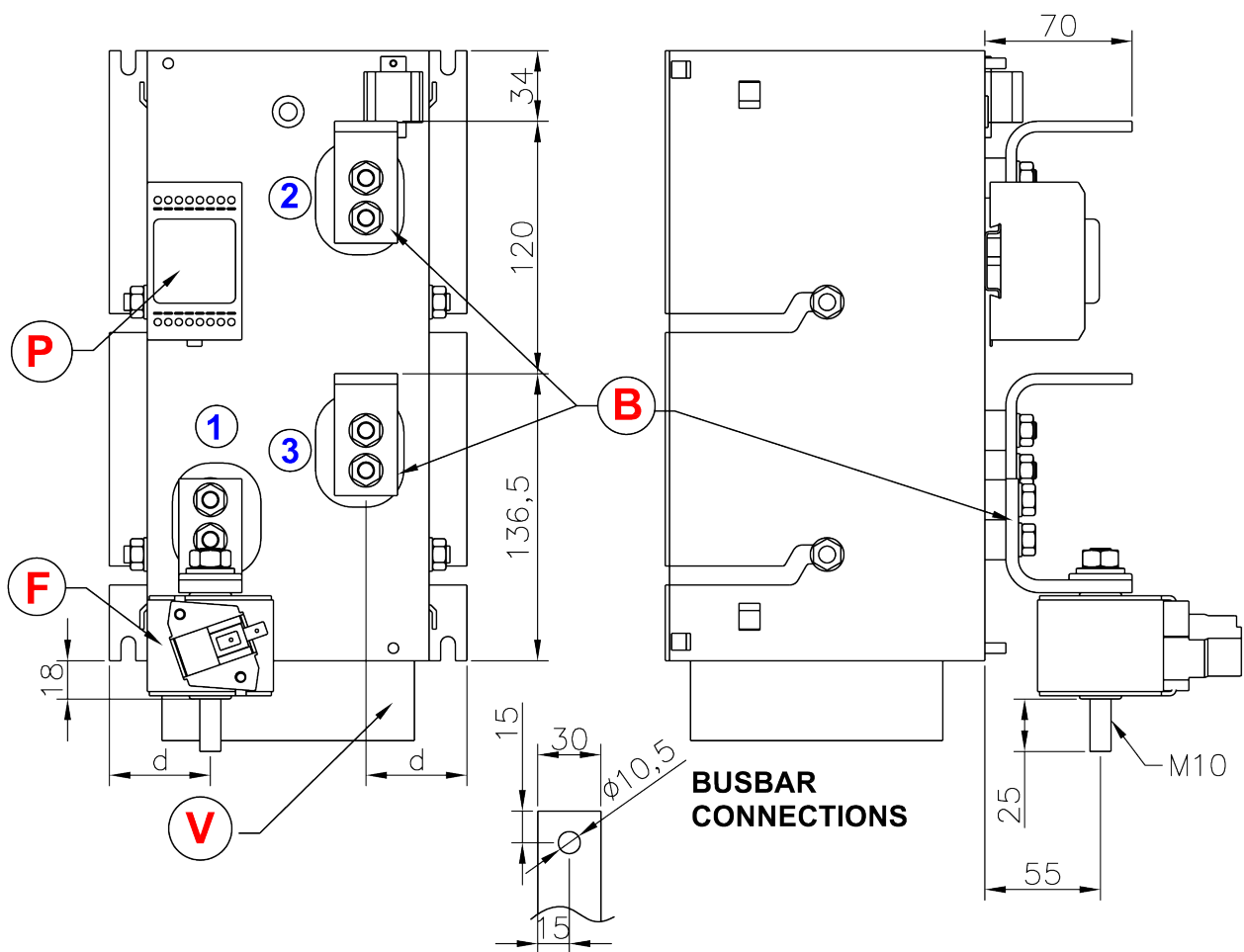

All dimensions are in mm.

Mechanical Drawings

The drawing shows the version with optional busbars (B option), fuses (F option) and anti-parallel busbar (L option). In the drawing are also present options P (pulse transformer) and V (fan).

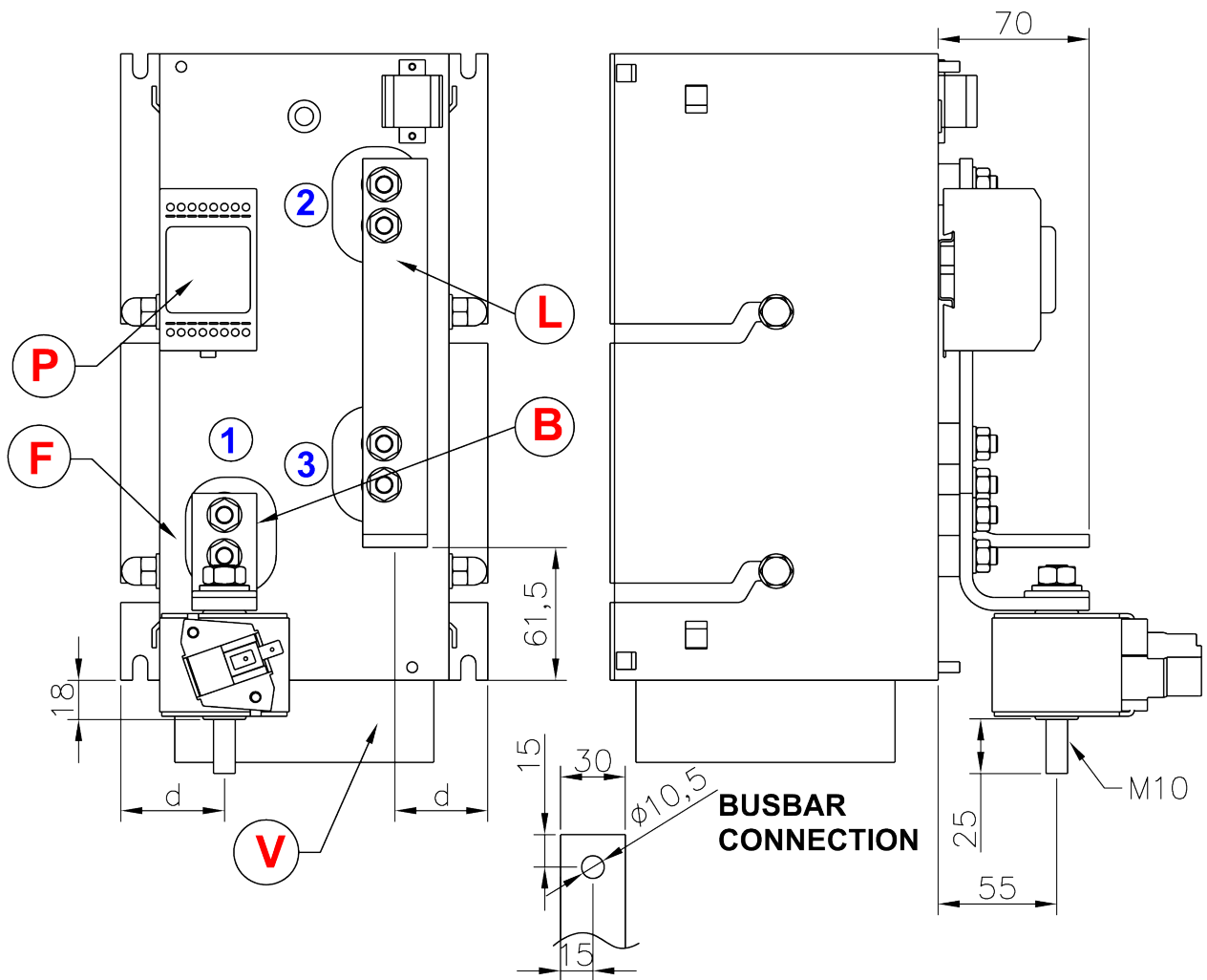

All dimensions are in mm.

Mechanical Drawings

The drawing shows the version with optional busbars (B option) and anti-parallel busbar (L option). In the drawing are also present options P (pulse transformer) and V (fan).

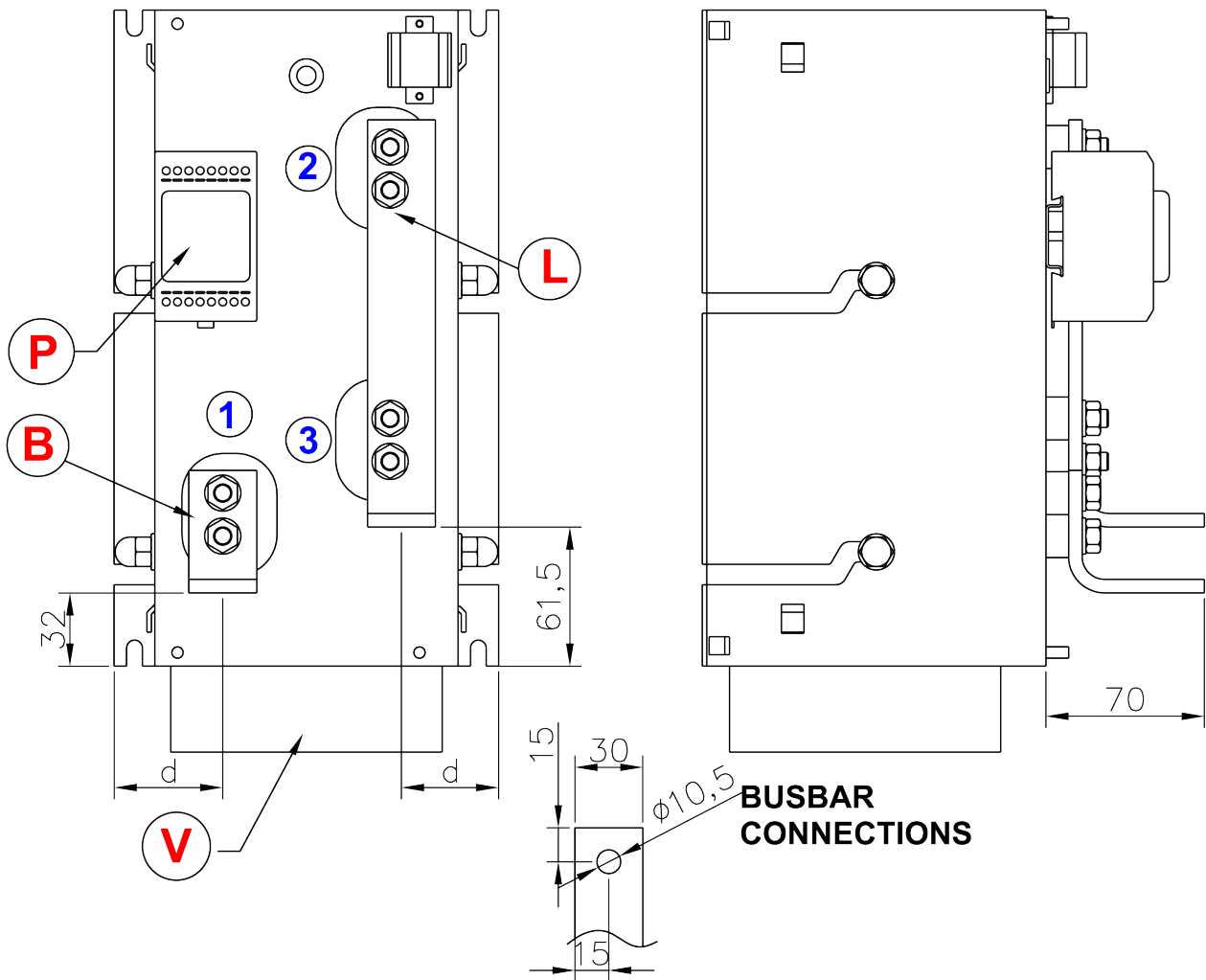

All dimensions are in mm.