

# SMD Power Inductor CDPH4D19F

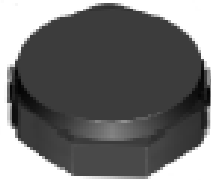

Halogen Free



## Description

- Ferrite drum core construction.
- Magnetically shielded.
- L × W × H: 5.2 × 5.2 × 2.0mm Max.
- Product weight: 160mg(Ref.)
- Moisture Sensitivity Level: 1
- RoHS compliance.
- Halogen Free available.

## Dimension - [mm]

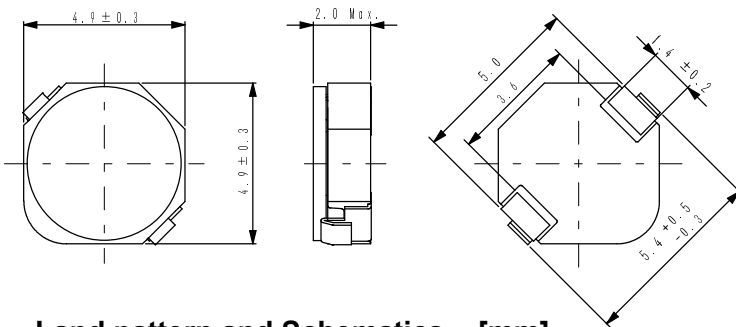

## Land pattern and Schematics - [mm]

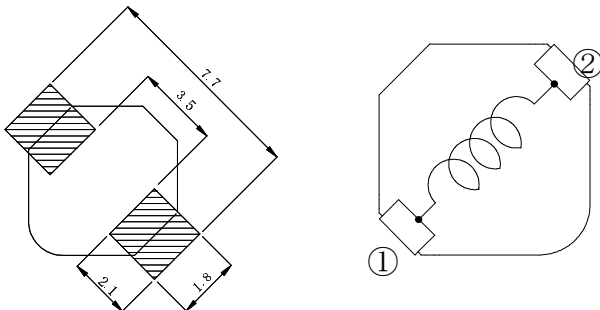

## Environmental Data

- Operating temperature range: -40°C~+105°C (including coil's self temperature rise)
- Storage temperature range: -40°C~+105°C
- Solder reflow temperature: 260 °C peak.

## Packaging

- Carrier tape and reel packaging.
- 7.0" diameter reel
- 1000pcs per reel

## Applications

- Ideally used in Notebook PC, MP3, Mobile Phone, DSC/DVC, etc as DC-DC Converter inductors.

## Electrical Characteristics

Part Name	Stamp	Inductance (μH) [within] ※1	D.C.R. (mΩ) Max. (Typ.) (at 20°C)	Saturation Current (A) ※2	Temperature Rise Current (A) ※3
CDPH4D19FNP-3R3MC	3R3	3.3 ± 20%	33(26)	1.50	3.80
CDPH4D19FNP-4R7MC	4R7	4.7 ± 20%	38(30)	1.15	3.30
CDPH4D19FNP-6R8MC	6R8	6.8 ± 20%	50(40)	1.00	3.02
CDPH4D19FNP-8R0MC	8R0	8.0 ± 20%	56(45)	0.90	2.68
CDPH4D19FNP-100MC	100	10 ± 20%	65(52)	0.80	2.32
CDPH4D19FNP-150MC	150	15 ± 20%	95(75)	0.66	1.88
CDPH4D19FNP-220MC	220	22 ± 20%	135(108)	0.54	1.44
CDPH4D19FNP-330MC	330	33 ± 20%	200(160)	0.43	1.25
CDPH4D19FNP-470MC	470	47 ± 20%	293(234)	0.36	1.03

※1. Inductance measuring condition: at 100kHz.

※2. Saturation current: The value of D.C. current when the inductance decreases to 65% of it's nominal value.

※3. Temperature rise current: The value of D.C. current when the temperature rise is Δt=40°C(Ta=20°C).

# SMD Power Inductor CDPH4D19F



## Saturation Current & Temperature Rise Graph

— L (20°C) — L (100°C) —  $\Delta T$

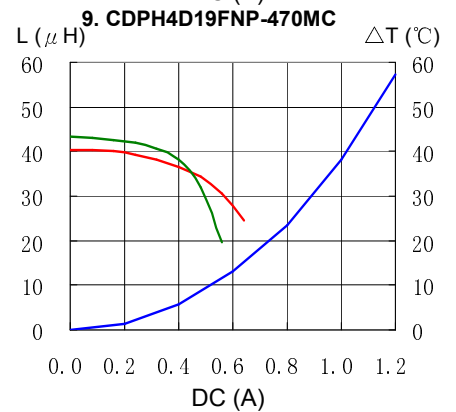
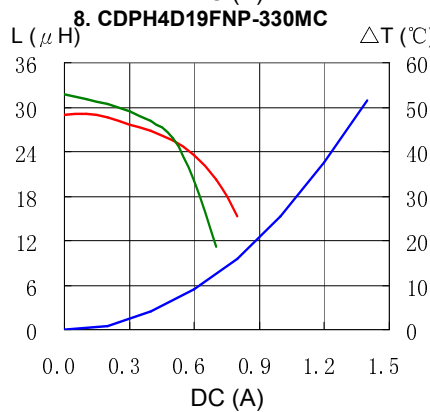
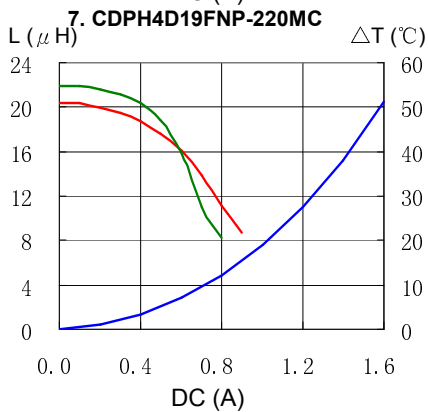
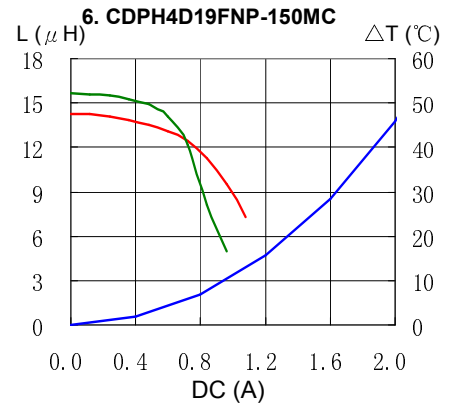
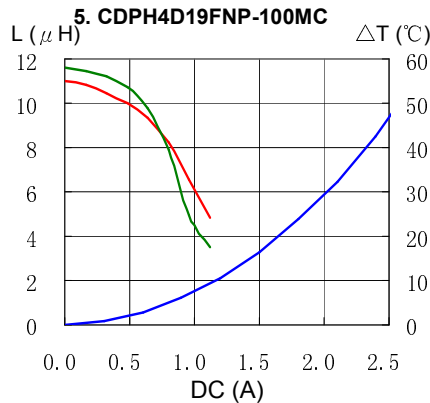
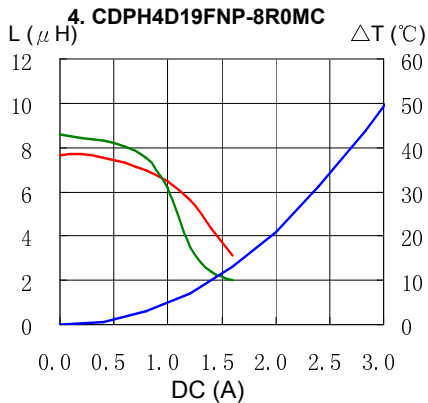
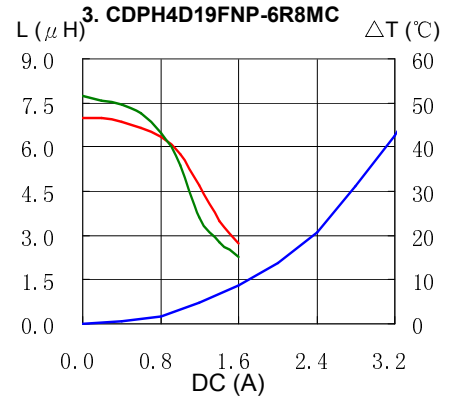
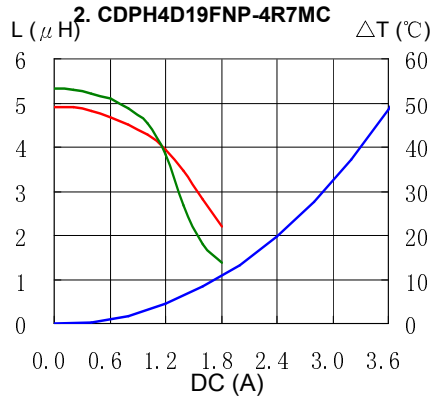
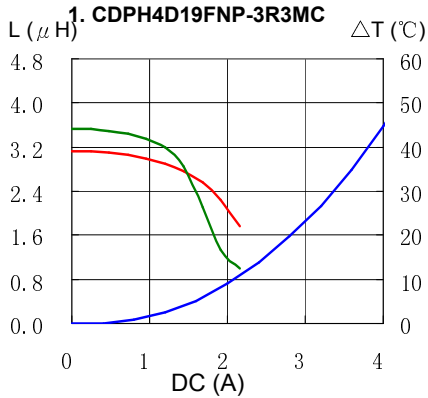

# SMD Power Inductor CDPH4D19F



## Solder Reflow Condition

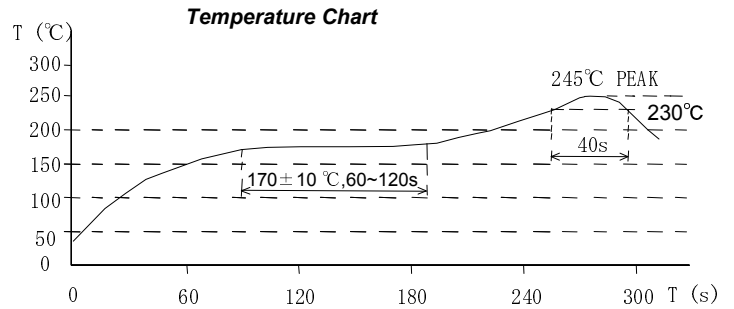
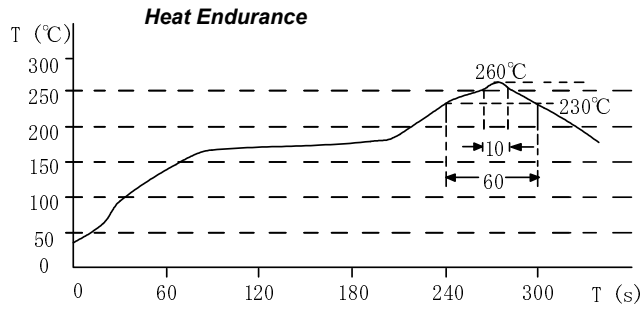

Please refer to the sales offices on our website - <http://www.sumida.com>

### Hong Kong

Tel.+852-2880-6781  
FAX.+852-2565-9600  
[sales@hk.sumida.com](mailto:sales@hk.sumida.com)

### Saitama(Japan)

Tel.+81-48-691-7300  
FAX.+81-48-691-7340  
[sales@jp.sumida.com](mailto:sales@jp.sumida.com)

### Chicago

Tel.+1-847-545-6700  
FAX. +1-847-545-6720  
[sales@us.sumida.com](mailto:sales@us.sumida.com)

### Shanghai

Tel.+86-21-5836-3299  
FAX.+86-21-5836-3266  
[shanghai.sales@cn.sumida.com](mailto:shanghai.sales@cn.sumida.com)

### Seoul

Tel.+82-2-6237-0777  
FAX.+82-2-6237-0778  
[sales@kr.sumida.com](mailto:sales@kr.sumida.com)

### Oberzell

Tel.+49-8591-937-0  
FAX. +49-8591-937-103  
[contact@eu.sumida.com](mailto:contact@eu.sumida.com)

### Shenzhen

Tel.+86-755-8291-0228  
FAX.+86-755-8291-0338  
[shenzhen.sales@cn.sumida.com](mailto:shenzhen.sales@cn.sumida.com)

### Singapore

Tel.+65-6296-3388  
FAX.+65-6841-4426  
[sales@sg.sumida.com](mailto:sales@sg.sumida.com)

### Neumarkt

Tel.+49-9181-4509-110  
FAX. +49-9181-4509-310  
[infocomp@eu.sumida.com](mailto:infocomp@eu.sumida.com)

### Taipei

Tel.+886-2-8751-2737  
FAX.+886-2-8751-2738  
[sales@tw.sumida.com](mailto:sales@tw.sumida.com)

### San Jose

Tel.+1-408-321-9660  
FAX.+1-408-321-9308  
[sales@us.sumida.com](mailto:sales@us.sumida.com)