

N-Channel Enhancement Mode Power MOSFET

MTB4D0N03BE3

Features

- Low On Resistance
- Simple Drive Requirement
- Low Gate Charge
- Fast Switching Characteristic
- RoHS compliant package

BV_{DSS}	30V
I_D@V_{GS}=10V, T_C=25°C	56A
I_D@V_{GS}=10V, T_A=25°C	13A
R_{DS(ON)}@V_{GS}=10V, I_D=20A	4.1 mΩ (typ)
R_{DS(ON)}@V_{GS}=4.5V, I_D=10A	5.5 mΩ (typ)

Symbol

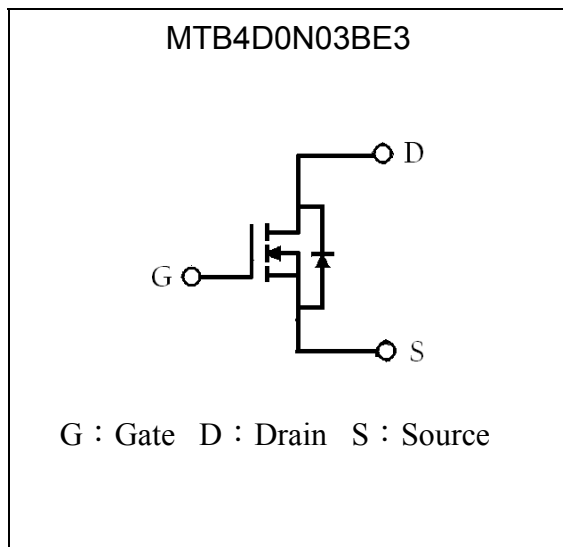

Outline

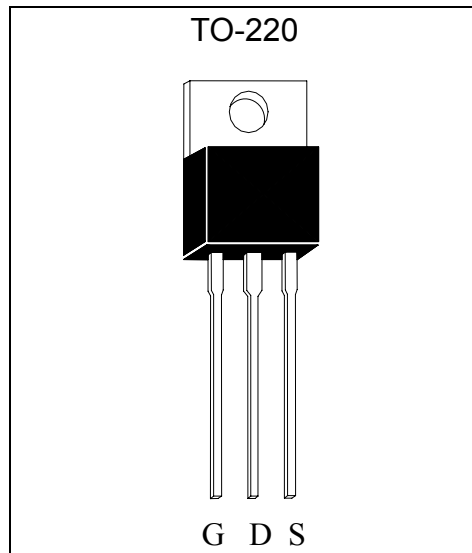

Ordering Information

Device	Package	Shipping
MTB4D0N03BE3-0-UB-X	TO-220 (RoHS compliant)	50 pcs/tube, 20 tubes/box, 4 boxes / carton

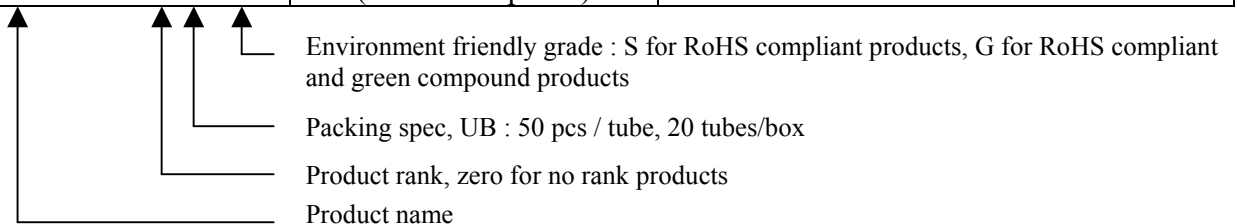

**Absolute Maximum Ratings** ($T_C=25^{\circ}\text{C}$)

Parameter	Symbol	Limits	Unit	
Drain-Source Voltage (Note 1)	V_{DS}	30	V	
Gate-Source Voltage	V_{GS}	± 20		
Continuous Drain Current @ $T_C=25^{\circ}\text{C}$, $V_{GS}=10\text{V}$ (silicon limit) (Note 1)	I_D	70	A	
Continuous Drain Current @ $T_C=25^{\circ}\text{C}$, $V_{GS}=10\text{V}$ (package limit) (Note 1)		56		
Continuous Drain Current @ $T_C=100^{\circ}\text{C}$, $V_{GS}=10\text{V}$ (Note 1)		44		
Continuous Drain Current @ $T_A=25^{\circ}\text{C}$, $V_{GS}=10\text{V}$ (Note 2)	I_{DSM}	13.3		
Continuous Drain Current @ $T_A=70^{\circ}\text{C}$, $V_{GS}=10\text{V}$ (Note 2)		10.6		
Pulsed Drain Current	I_{DM}	280		
Avalanche Current	I_{AS}	40		
Single Pulse Avalanche Energy @ $L=0.1\text{mH}$, $I_D=40\text{Amps}$, $V_{DD}=15\text{V}$ (Note 4)	E_{AS}	80	mJ	
Repetitive Avalanche Energy (Note 3)	E_{AR}	6		
Power Dissipation	$T_C=25^{\circ}\text{C}$ (Note 1)	P_D	57	W
	$T_C=100^{\circ}\text{C}$ (Note 1)		23	
	$T_A=25^{\circ}\text{C}$ (Note 2)	P_{DSM}	2.1	
	$T_A=70^{\circ}\text{C}$ (Note 2)		1.3	
Maximum Temperature for Soldering @ Lead at 0.063 in(1.6mm) from case for 10 seconds	T_L	300	$^{\circ}\text{C}$	
Maximum Temperature for Soldering @ Package Body for 10 seconds	T_{PKG}	260		
Operating Junction and Storage Temperature	T_j, T_{stg}	-55~+150		

*Drain current limited by maximum junction temperature

Thermal Data

Parameter	Symbol	Value	Unit
Thermal Resistance, Junction-to-case, max	$R_{\theta JC}$	2.2	$^{\circ}\text{C}/\text{W}$
Thermal Resistance, Junction-to-ambient, max (Note 2)	$R_{\theta JA}$	60	

- Note : 1. The power dissipation P_D is based on $T_{J(MAX)}=150^{\circ}\text{C}$, using junction-to-case thermal resistance, and is more useful in setting the upper dissipation limit for cases where additional heatsinking is used.
2. The value of $R_{\theta JA}$ is measured with the device mounted on 1 in² FR-4 board with 2 oz. copper, in a still air environment with $T_A=25^{\circ}\text{C}$. The power dissipation P_{DSM} is based on $R_{\theta JA}$ and the maximum allowed junction temperature of 150°C . The value in any given application depends on the user's specific board design.
3. Pulse width limited by junction temperature $T_{J(MAX)}=150^{\circ}\text{C}$.
4. Ratings are based on low frequency and low duty cycles to keep initial $T_J=25^{\circ}\text{C}$. 100% tested by condition of $V_{DD}=15\text{V}$, $I_D=15\text{A}$, $L=0.5\text{mH}$, $V_{GS}=10\text{V}$.



Characteristics (Tj=25°C, unless otherwise specified)

Symbol	Min.	Typ.	Max.	Unit	Test Conditions
Static					
BV _{DSS}	30	-	-	V	V _{GS} =0V, I _D =250μA
ΔBV _{DSS} /ΔT _j	-	29	-	mV/°C	Reference to 25°C, I _D =250μA
V _{GS(th)}	1.5	-	2.5	V	V _{DS} = V _{GS} , I _D =250μA
*G _{FS}	-	19.7	-	S	V _{DS} =10V, I _D =20A
I _{GSS}	-	-	±100	nA	V _{GS} =±20V
I _{DSS}	-	-	1	μA	V _{DS} =24V, V _{GS} =0V
	-	-	5		V _{DS} =24V, V _{GS} =0V, T _j =55°C
*R _{DS(ON)}	-	4.1	5.4	mΩ	V _{GS} =10V, I _D =20A
	-	5.5	7.8		V _{GS} =4.5V, I _D =10A
Dynamic					
*Q _g (V _{GS} =10V)	-	32.3	-	nC	V _{DS} =15V, V _{GS} =10V, I _D =20A
*Q _g (V _{GS} =4.5V)	-	17	-		
*Q _{gs}	-	5.2	-		
*Q _{gd}	-	8.4	-		
*t _{d(ON)}	-	13	-	ns	V _{DS} =15V, I _D =20A, V _{GS} =10V, R _{GS} =2.7Ω
*t _r	-	16.6	-		
*t _{d(OFF)}	-	44	-		
*t _f	-	11.6	-		
C _{iss}	-	1446	-	pF	V _{GS} =0V, V _{DS} =15V, f=1MHz
C _{oss}	-	274	-		
C _{rss}	-	194	-		
Source-Drain Diode					
*I _S	-	-	56	A	
*I _{SM}	-	-	280		
*V _{SD}	-	0.83	1.2	V	I _S =20A, V _{GS} =0V
*t _{rr}	-	15.5	-	ns	V _{GS} =0V, I _F =20A, dI _F /dt=100A/μs
*Q _{rr}	-	8.5	-	nC	

*Pulse Test : Pulse Width ≤300μs, Duty Cycle≤2%

Typical Characteristics

Typical Output Characteristics

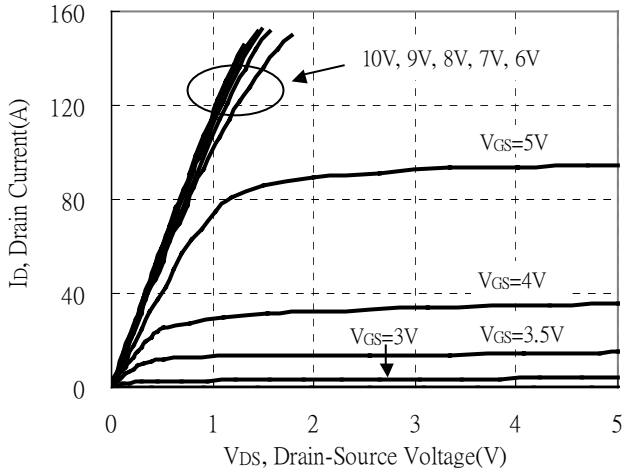

Brekdown Voltage vs Ambient Temperature

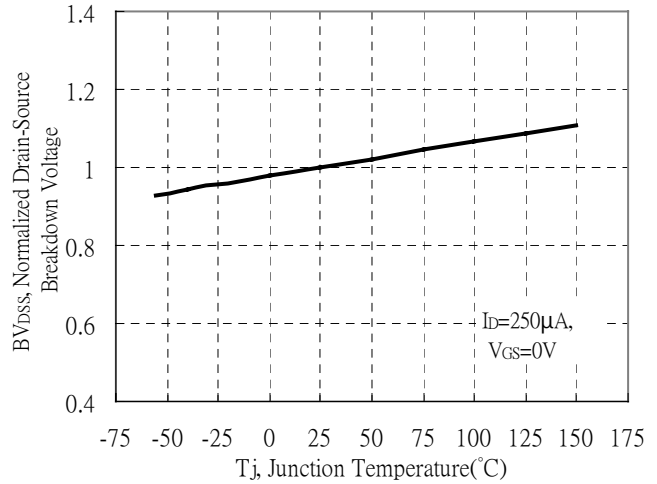

Static Drain-Source On-State resistance vs Drain Current

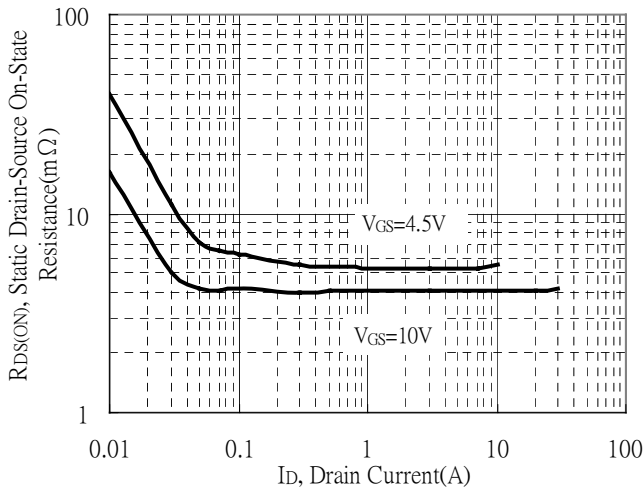

Reverse Drain Current vs Source-Drain Voltage

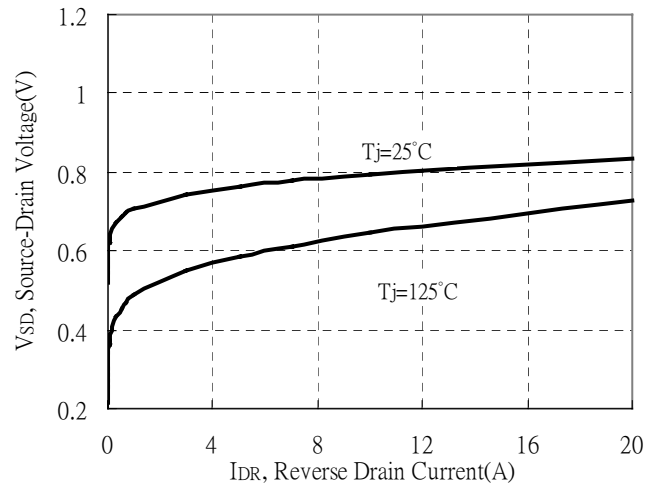

Static Drain-Source On-State Resistance vs Gate-Source Voltage

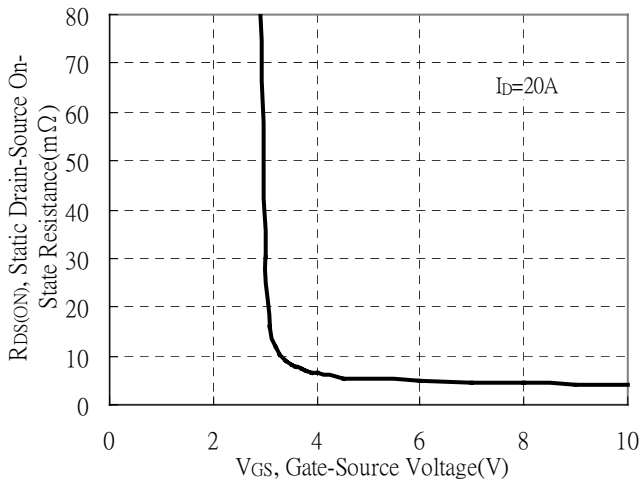

Drain-Source On-State Resistance vs Junction Temperature

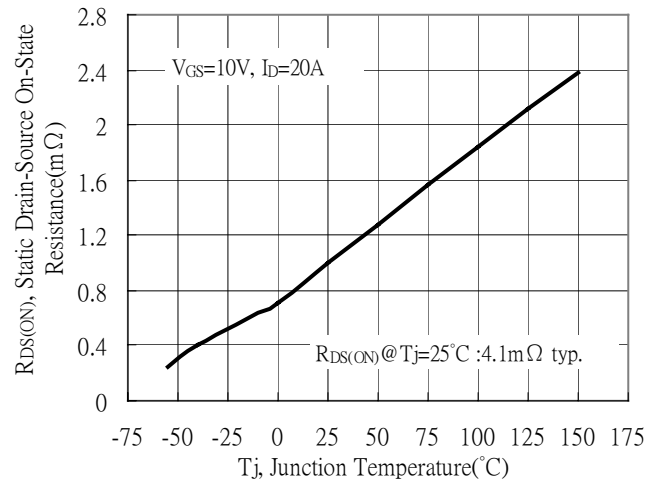

Typical Characteristics(Cont.)

Capacitance vs Drain-to-Source Voltage

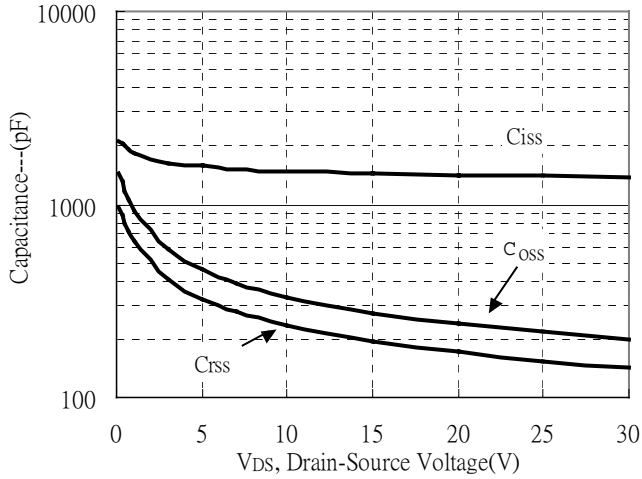

Threshold Voltage vs Junction Temperature

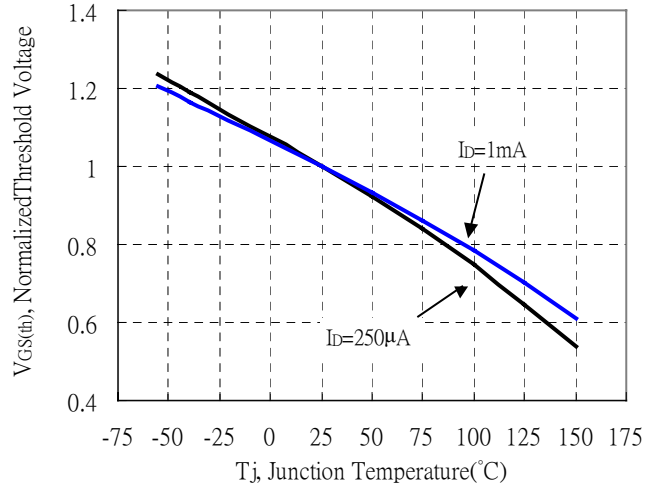

Forward Transfer Admittance vs Drain Current

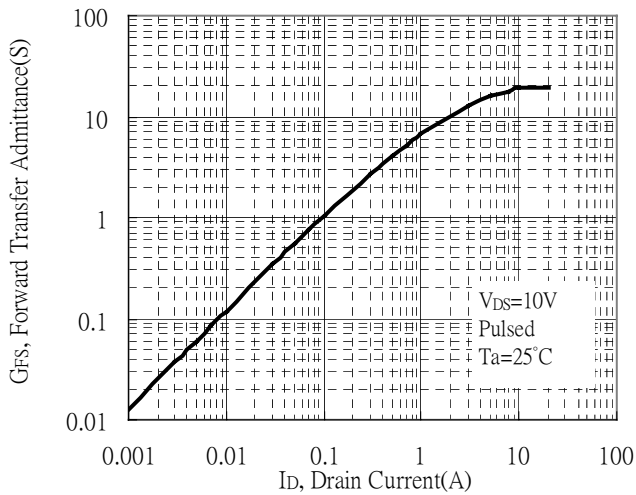

Gate Charge Characteristics

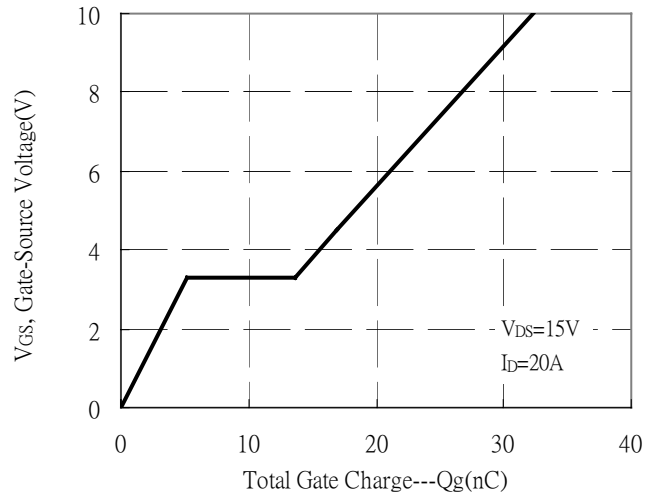

Maximum Safe Operating Area

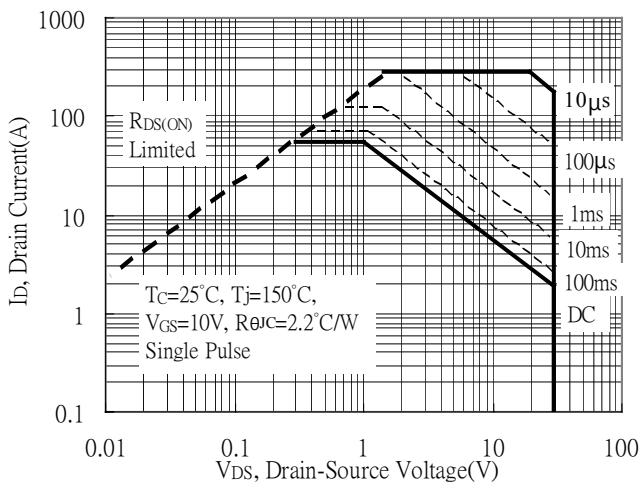

Maximum Drain Current vs Case Temperature

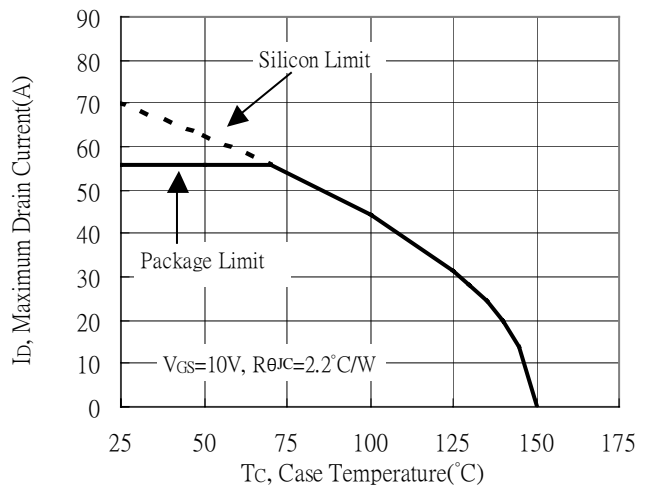



Typical Characteristics(Cont.)

Typical Transfer Characteristics

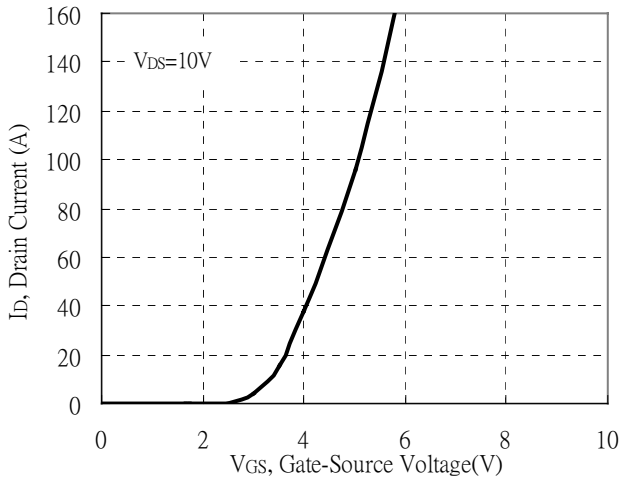

Single Pulse Maximum Power Dissipation

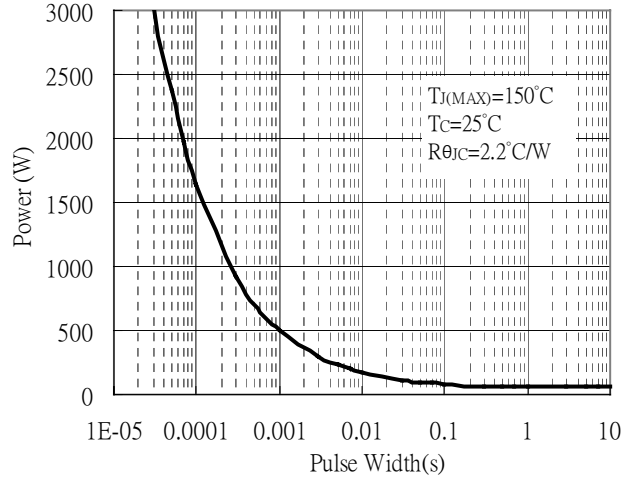

Transient Thermal Response Curves

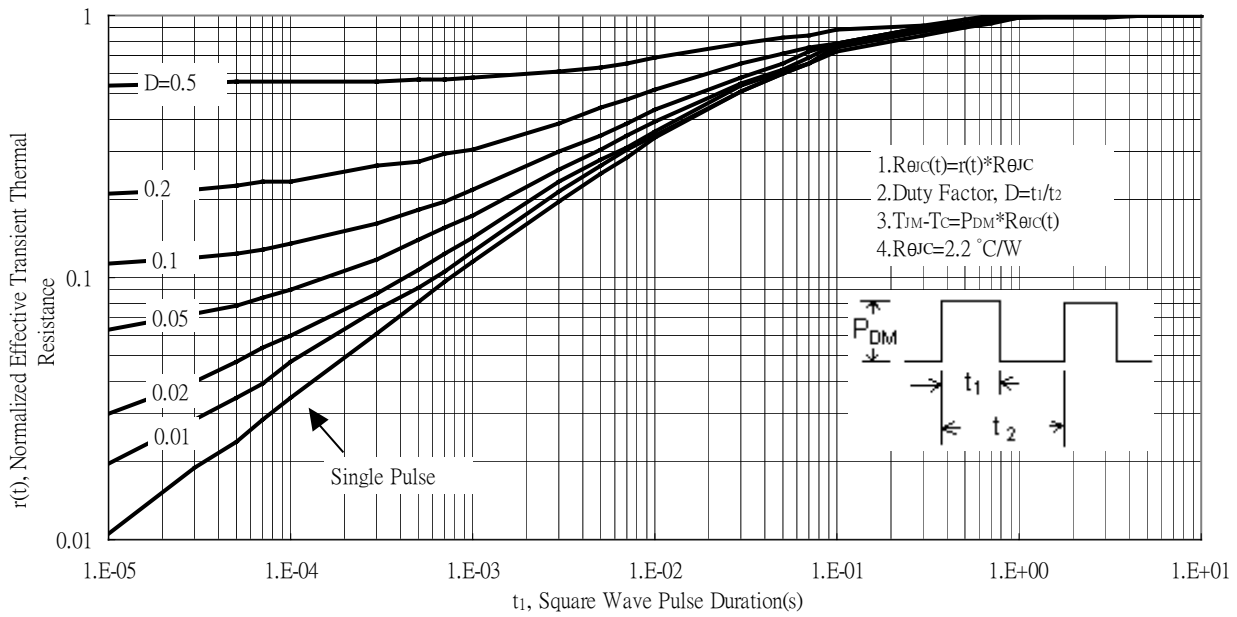

Recommended wave soldering condition

Product	Peak Temperature	Soldering Time
Pb-free devices	260 +0/-5 °C	5 +1/-1 seconds

Recommended temperature profile for IR reflow

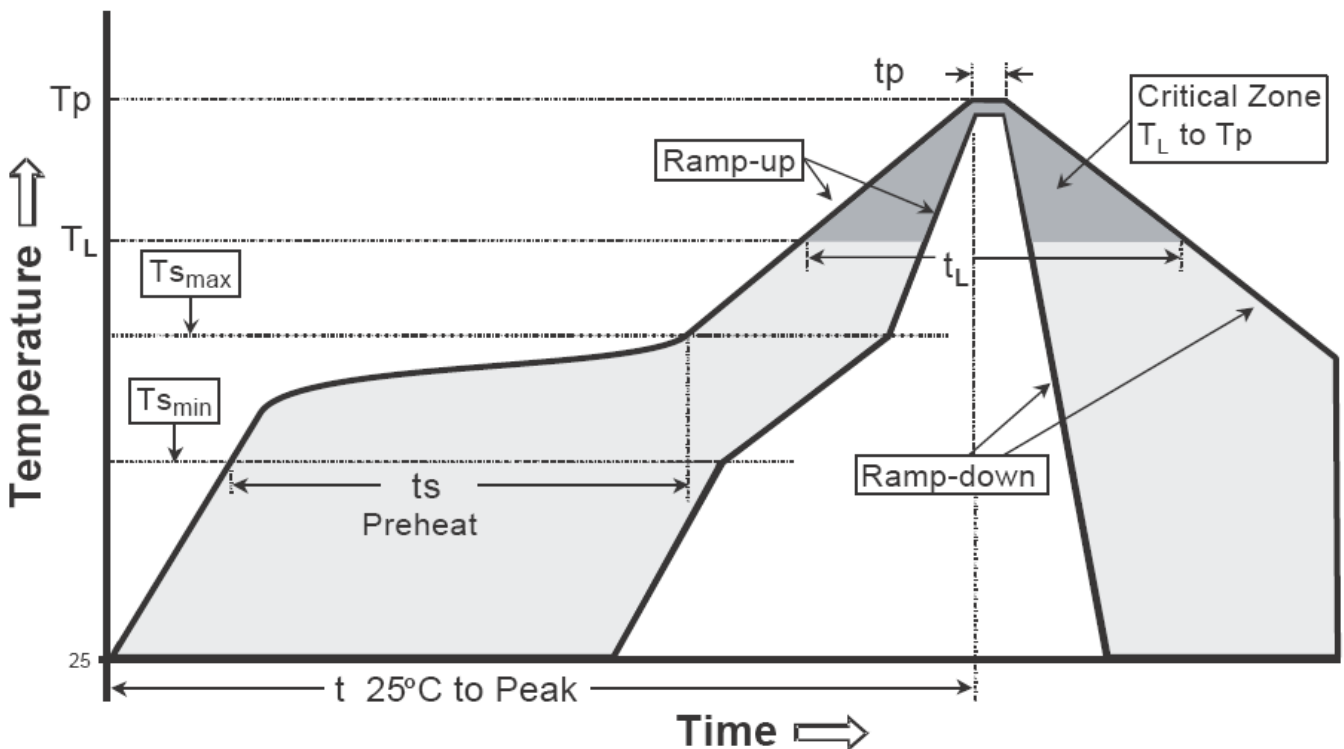

Profile feature	Sn-Pb eutectic Assembly	Pb-free Assembly
Average ramp-up rate (T _s max to T _p)	3°C/second max.	3°C/second max.
Preheat		
-Temperature Min(T _s min)	100°C	150°C
-Temperature Max(T _s max)	150°C	200°C
-Time(t _s min to t _s max)	60-120 seconds	60-180 seconds
Time maintained above:		
-Temperature (T _L)	183°C	217°C
- Time (t _L)	60-150 seconds	60-150 seconds
Peak Temperature(T _P)	240 +0/-5 °C	260 +0/-5 °C
Time within 5°C of actual peak temperature(tp)	10-30 seconds	20-40 seconds
Ramp down rate	6°C/second max.	6°C/second max.
Time 25 °C to peak temperature	6 minutes max.	8 minutes max.

Note : All temperatures refer to topside of the package, measured on the package body surface.

TO-220 Dimension

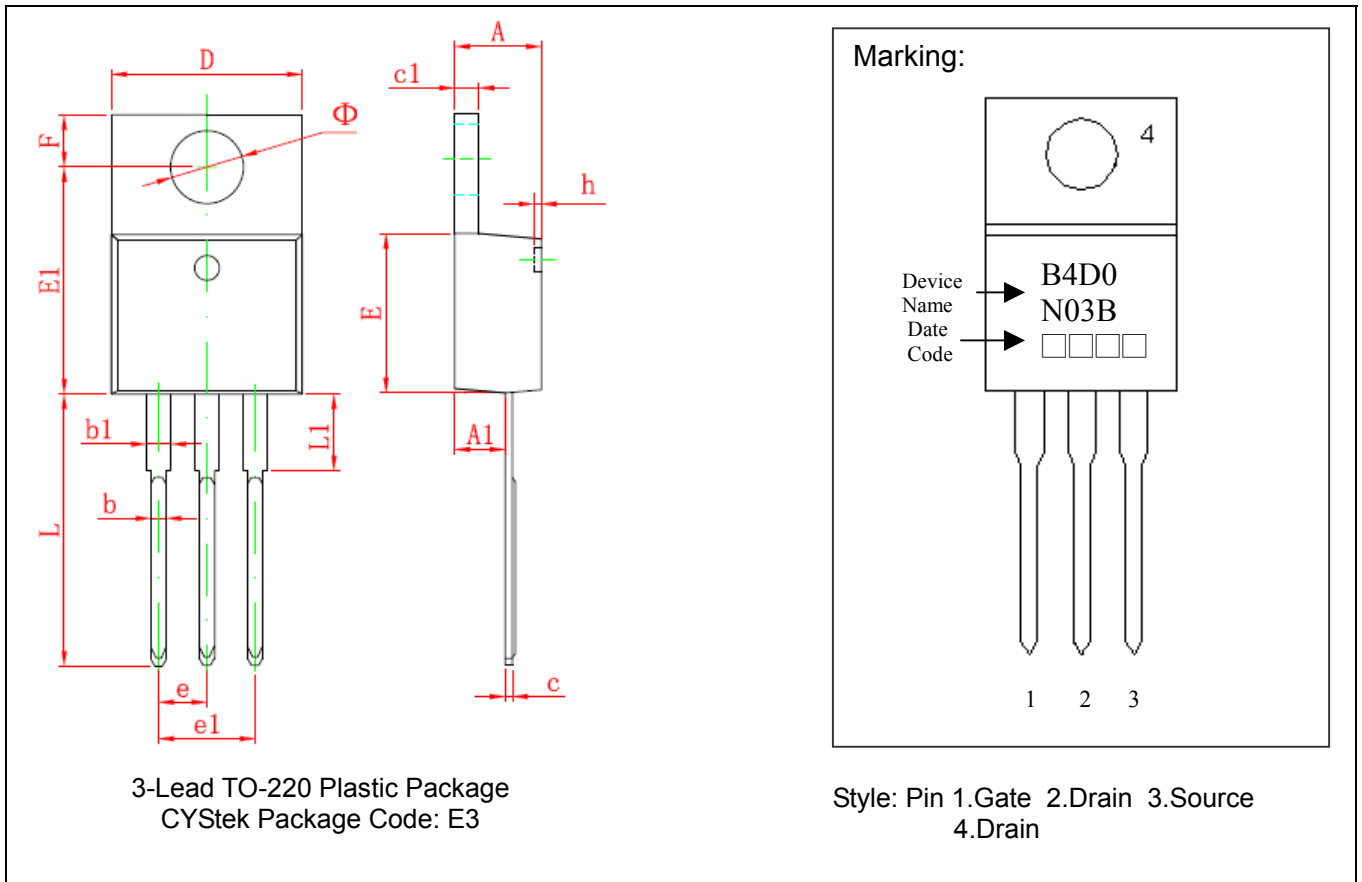

*: Typical

DIM	Millimeters		Inches		DIM	Millimeters		Inches	
	Min.	Max.	Min.	Max.		Min.	Max.	Min.	Max.
A	4.470	4.670	0.176	0.184	E1	12.060	12.460	0.475	0.491
A1	2.520	2.820	0.099	0.111	e	2.540*		0.100*	
b	0.710	0.910	0.028	0.036	e1	4.980	5.180	0.196	0.204
b1	1.170	1.370	0.046	0.054	F	2.590	2.890	0.102	0.114
c	0.310	0.530	0.012	0.021	h	0.000	0.300	0.000	0.012
c1	1.170	1.370	0.046	0.054	L	13.400	13.800	0.528	0.543
D	10.010	10.310	0.394	0.406	L1	3.560	3.960	0.140	0.156
E	8.500	8.900	0.335	0.350	Φ	3.735	3.935	0.147	0.155

Notes: 1.Controlling dimension: millimeters.
 2.Maximum lead thickness includes lead finish thickness, and minimum lead thickness is the minimum thickness of base material.
 3.If there is any question with packing specification or packing method, please contact your local CYStek sales office.

Material:

- Lead: Pure tin plated.
- Mold Compound: Epoxy resin family, flammability solid burning class: UL94V-0.

Important Notice:

- All rights are reserved. Reproduction in whole or in part is prohibited without the prior written approval of CYStek.
- CYStek reserves the right to make changes to its products without notice.
- CYStek **semiconductor products are not warranted to be suitable for use in Life-Support Applications, or systems.**
- CYStek assumes no liability for any consequence of customer product design, infringement of patents, or application assistance.