

FRED

Ultrafast, Soft Recovery Diode

**Features**

- Reduced RFI and EMI
- Reduced Snubbing
- Extensive Characterization of Recovery Parameters
- Hermetic
- Electrically Isolated
- Ceramic Eyelets
- ESD Rating: Class 3B per MIL-STD-750, Method 1020

$V_R = 600V$
$V_F = 1.9V$
$Q_{rr} = 270nC$
$di_{(rec)}/dt = 345A/\mu s$

**Description**

These Ultrafast, soft recovery diodes are optimized to reduce losses and EMI/RFI in high frequency power conditioning systems. An extensive characterization of the recovery behavior for different values of current, temperature and di/dt simplifies the calculations of losses in the operating conditions. The softness of the recovery eliminates the need for a snubber in most applications. These devices are ideally suited for power converters, motors drives and other applications where switching losses are significant portion of the total losses.

**Absolute Maximum Ratings**

	Parameter	Max.	Units
$V_R$	Cathode to Anode Voltage (Per Leg)	600	V
$I_{F(AV)}$	Continuous Forward Current, ① $T_C = 100^\circ C$	30	A
$I_{FSM}$	Single Pulse Forward Current, ② $T_C = 25^\circ C$ (Per Leg)	150	
$P_D @ T_C = 25^\circ C$	Maximum Power Dissipation	63	W
$T_J, T_{STG}$	Operating Junction and Storage Temperature Range	-55 to +150	$^\circ C$

**Note:** ① D.C. = 50% rect. wave  
 ② 1/2 sine wave, 60 Hz , P.W. = 8.33 ms

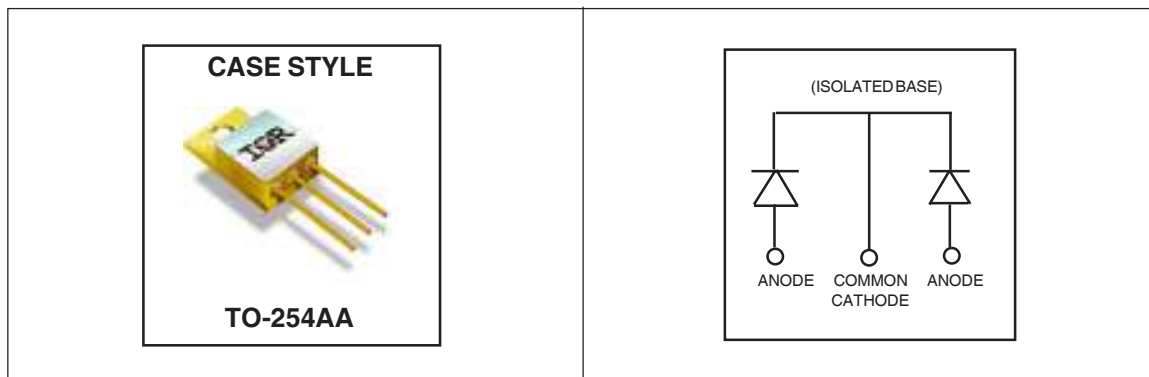

**Electrical Characteristics (Per Leg) @  $T_J = 25^\circ\text{C}$  (unless otherwise specified)**

	Parameter	Min.	Typ.	Max.	Units	Test Conditions
$V_{BR}$	Cathode Anode Breakdown Voltage	600	—	—	V	$I_R = 250\mu\text{A}$
$V_F$	Forward Voltage See Fig. 1	—	—	1.7	V	$I_F = 15\text{A}, T_J = -55^\circ\text{C}$
		—	—	1.9		$I_F = 15\text{A}, T_J = 25^\circ\text{C}$
		—	—	2.3		$I_F = 30\text{A}, T_J = 25^\circ\text{C}$
		—	—	2.1		$I_F = 15\text{A}, T_J = 125^\circ\text{C}$
$I_R$	Reverse Leakage Current See Fig. 2	—	—	10	$\mu\text{A}$	$V_R = V_R \text{ Rated}$
		—	—	1.0	$\text{mA}$	$V_R = 480\text{V}, T_J = 125^\circ\text{C}$
$C_T$	Junction Capacitance, See Fig. 3	—	24	36	$\text{pF}$	$V_R = 200\text{V}$
$L_S$	Series Inductance	—	8.7	—	$\text{nH}$	Measured from anode lead to cathode lead, 6mm ( 0.025 in. ) from package

**Dynamic Recovery Characteristics (Per Leg) @  $T_J = 25^\circ\text{C}$  (unless otherwise specified)**

	Parameter	Min.	Typ.	Max.	Units	Test Conditions
$t_{rr1}$	Reverse Recovery Time	—	54	88	ns	$T_J = 25^\circ\text{C}$ See Fig. 5
$t_{rr2}$		—	94	140		$T_J = 125^\circ\text{C}$
$I_{RRM1}$	Peak Recovery Current	—	5.6	7.8	A	$T_J = 25^\circ\text{C}$ See Fig. 6
$I_{RRM2}$		—	7.8	11.7		$T_J = 125^\circ\text{C}$
$Q_{rr1}$	Reverse Recovery Charge	—	180	270	$\text{nC}$	$T_J = 25^\circ\text{C}$ See Fig. 7
$Q_{rr2}$		—	435	650		$T_J = 125^\circ\text{C}$
$di_{(rec)M}/dt1$	Peak Rate of Fall of Recovery Current During $t_b$	—	300	345	$\text{A}/\mu\text{s}$	$T_J = 25^\circ\text{C}$ See Fig. 8
$di_{(rec)M}/dt2$		—	190	285		$T_J = 125^\circ\text{C}$

**Thermal - Mechanical Characteristics**

	Parameter	Typ.	Max.	Units
$R_{thJC}$	Junction-to-Case, Single Leg Conducting	—	2.0	$^\circ\text{C}/\text{W}$
Wt	Weight	9.3	—	g

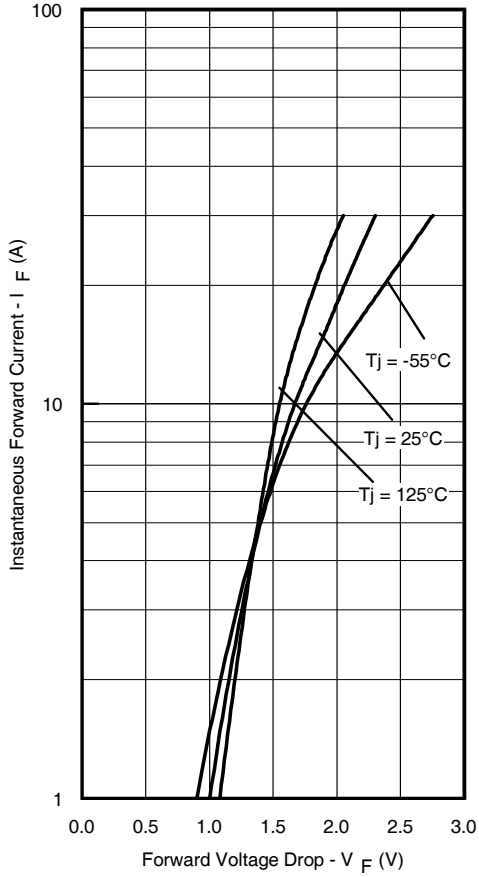

Fig. 1 - Maximum Forward Voltage Drop Vs. Instantaneous Forward Current (Per Leg)

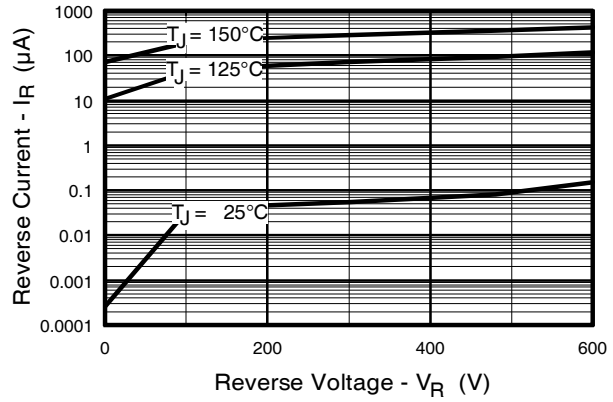

Fig. 2 - Typical Reverse Current Vs. Reverse Voltage (Per Leg)

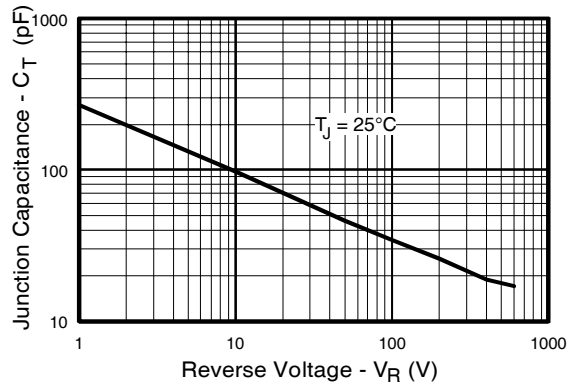

Fig. 3 - Typical Junction Capacitance Vs. Reverse Voltage (Per Leg)

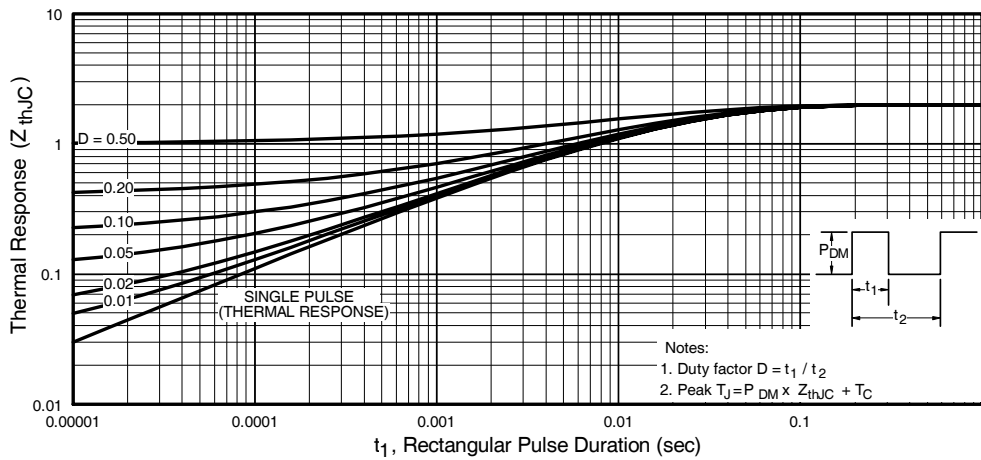

Fig. 4 - Maximum Thermal Impedance  $Z_{thJC}$  Characteristics (Per Leg)

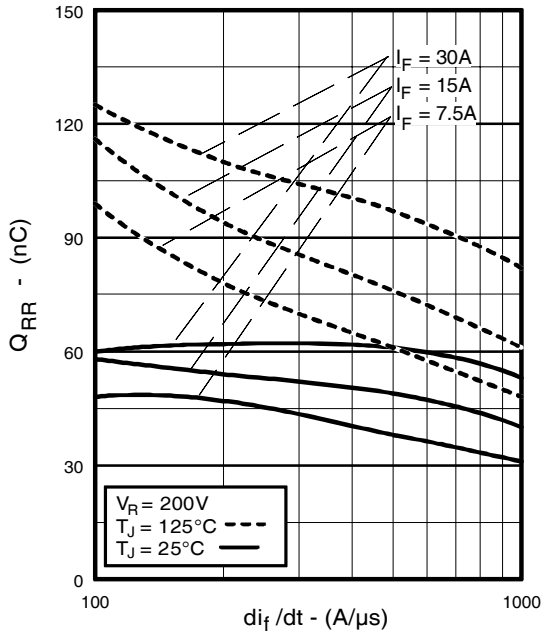

Fig. 5 - Typical Reverse Recovery Vs.  $di_f/dt$  (Per Leg)

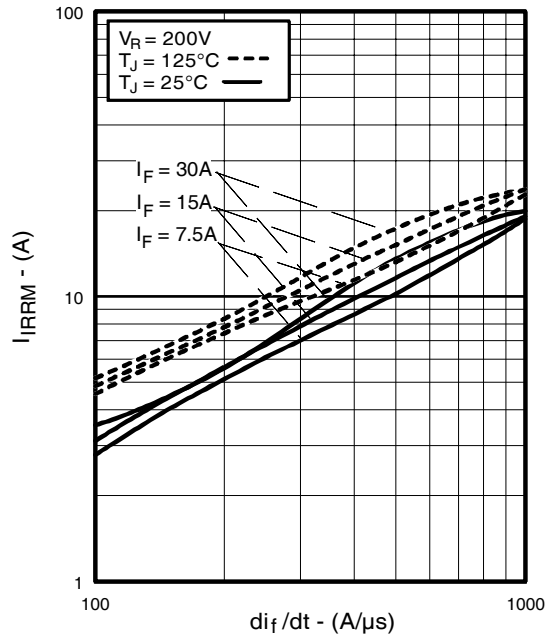

Fig. 6 - Typical Recovery Current Vs.  $di_f/dt$  (Per Leg)

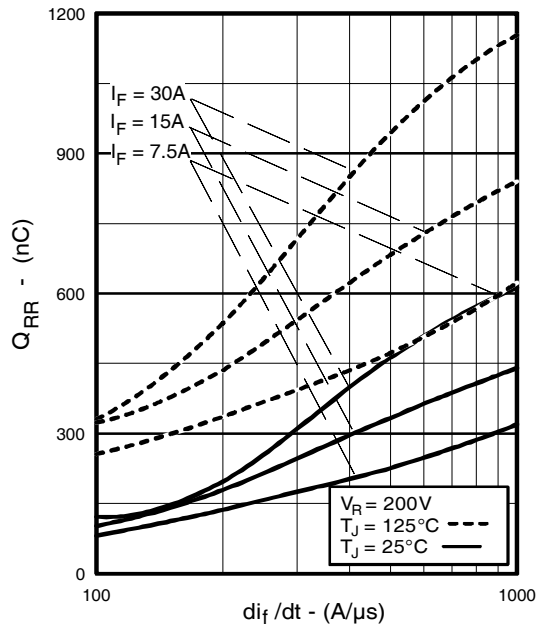

Fig. 7 - Typical Stored Charge Vs.  $di_f/dt$  (Per Leg)

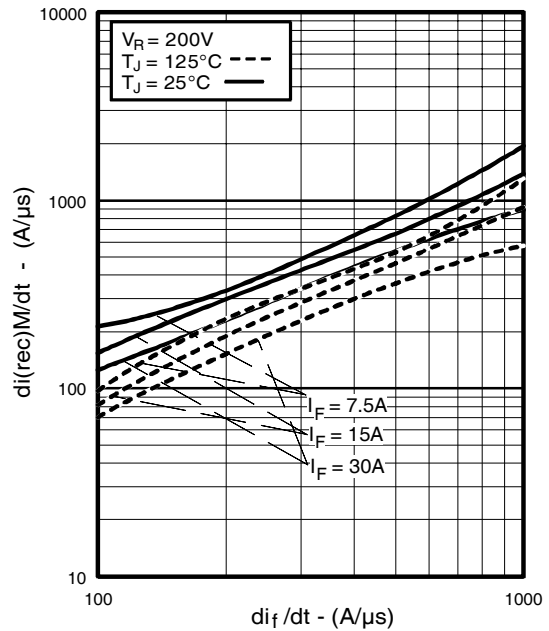

Fig. 8 - Typical  $di_{(rec)M}/dt$  Vs.  $di_f/dt$  (Per Leg)

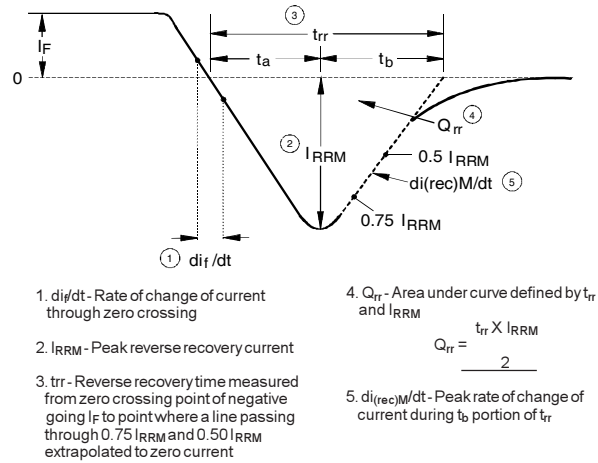
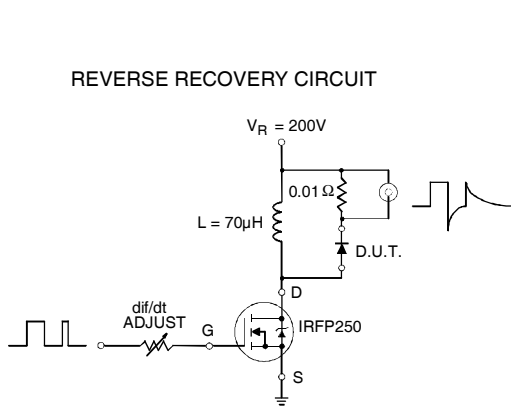
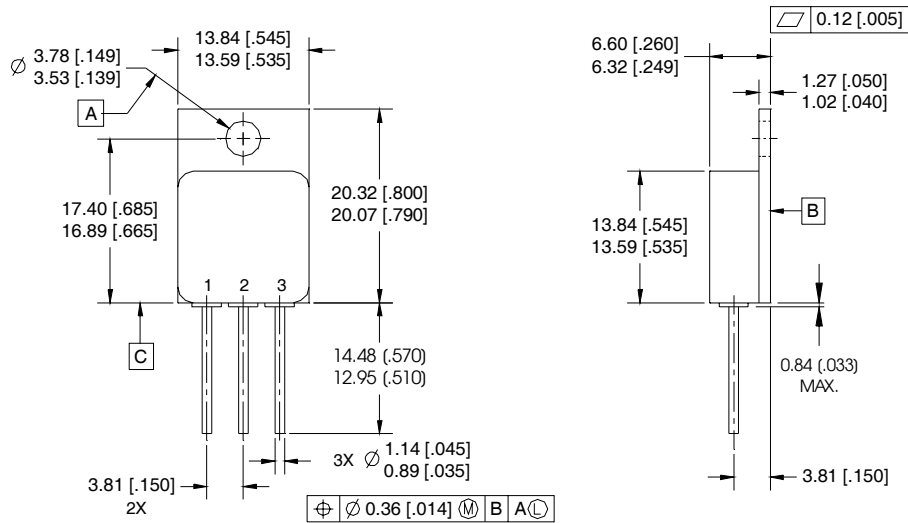

Fig. 9 - Reverse Recovery Parameter Test Circuit

Fig. 10 - Reverse Recovery Waveform and Definitions

**Case Outline and Dimensions — TO-254AA**



NOTES:

1. DIMENSIONING & TOLERANCING PER ASME Y14.5M-1994.
2. ALL DIMENSIONS ARE SHOWN IN MILLIMETERS (INCHES).
3. CONTROLLING DIMENSION: INCH.
4. CONFORMS TO JEDEC OUTLINE TO-254AA.

PIN ASSIGNMENTS

- 1 = ANODE 1
- 2 = COMMON CATHODE
- 3 = ANODE 2