



Low Power Peak EMI Reducing Solution

Features

- Generates an EMI optimized clocking signal at the output.
- Integrated loop filter components.
- Operates with a 3.3V ±10% supply.
- Operating current less than 6mA.
- Low power CMOS design.
- Input frequency range: 30MHz to 50MHz.
- Generates a 1X low EMI spread spectrum clock of the input frequency.
- Frequency deviation: ±0.75%.
- Available in 6-pin TSOT-23, 8-pin SOIC and 8-pin TSSOP packages.

Product Description

The ASM3P2780A is a versatile spread spectrum frequency modulator designed specifically for a wide range of clock frequencies. The ASM3P2780A reduces electromagnetic interference (EMI) at the clock source, allowing system wide reduction of EMI of all clock dependent signals. The ASM3P2780A allows significant system cost savings by reducing the number of circuit board layers ferrite beads, shielding that are traditionally required to pass EMI regulations.

The ASM3P2780A uses the most efficient and optimized modulation profile approved by the FCC and is implemented by using a proprietary all digital method.

The ASM3P2780A modulates the output of a single PLL in order to “spread” the bandwidth of a synthesized clock, and more importantly, decreases the peak amplitudes of its harmonics. This results in significantly lower system EMI compared to the typical narrow band signal produced by oscillators and most frequency generators. Lowering EMI by increasing a signal’s bandwidth is called ‘spread spectrum clock generation’.

Applications

The ASM3P2780A is targeted towards all portable devices with very low power requirements like MP3 players and digital still cameras.

Key Specifications

Description	Specification
Supply voltages	V _{DD} = 3.3V ±10%
Frequency Range	30MHz < CLKIN < 50MHz
Cycle-to-Cycle Jitter	300 ps (maximum)
Output Duty Cycle	40/60% (worst case)
Output Rise and Fall Time	1.1 ns (maximum)
Modulation Rate Equation	F _{IN} /1280
Frequency Deviation	±0.75%

Block Diagram

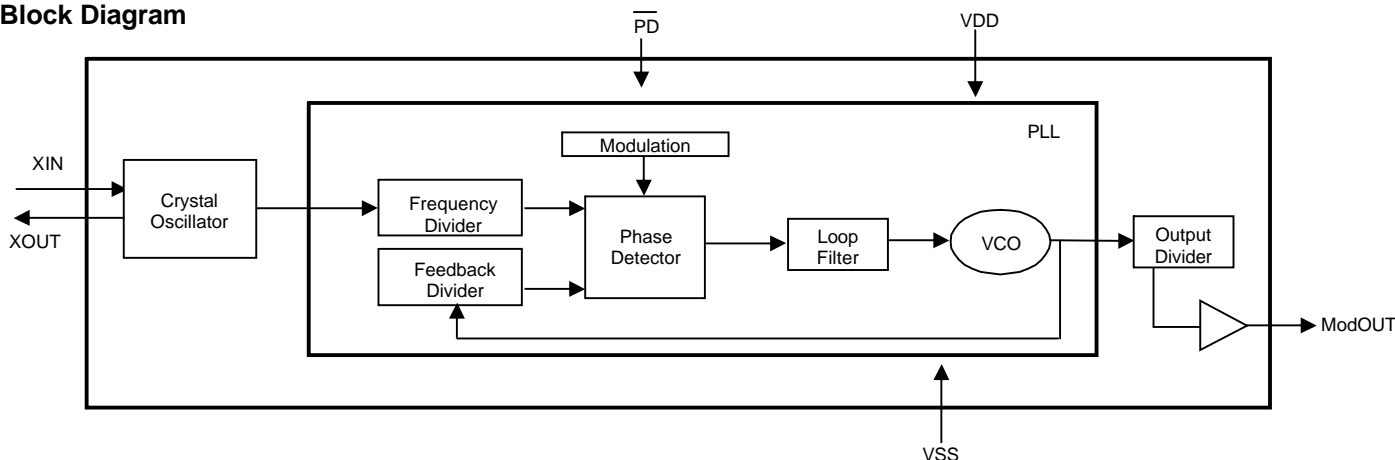



Pin Configuration (6-pin TSOT-23)

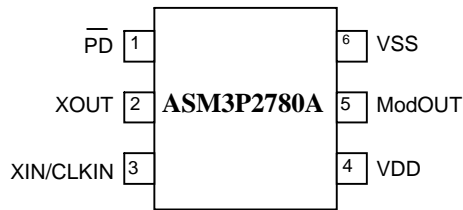

Pin#	Pin Name	Type	Description
1	$\overline{\text{PD}}$	I	Power-down control pin. Pull low to enable power-down mode. Connect to VDD if not used.
2	XOUT	O	Crystal connection. If using an external reference, this pin must be left unconnected.
3	XIN/CLKIN	I	Crystal connection or external reference frequency input. This pin has dual functions. It can be connected either to an external crystal or an external reference clock.
4	VDD	P	Power supply for the entire chip (3.3V)
5	ModOUT	O	Spread spectrum clock output.
6	VSS	P	Ground connection.



Pin Configuration (8-pin SOIC and TSSOP)

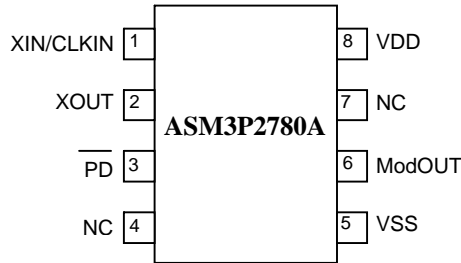

Pin Description

Pin#	Pin Name	Type	Description
1	XIN/CLKIN	I	Crystal connection or external reference frequency input. This pin has dual functions. It can be connected either to an external crystal or an external reference clock.
2	XOUT	O	Crystal connection. If using an external reference, this pin must be left unconnected.
3	$\overline{\text{PD}}$	I	Power-down control pin. Pull low to enable power-down mode. Connect to VDD if not used.
4	NC	-	No connect.
5	VSS	P	Ground connection.
6	ModOUT	O	Spread spectrum clock output.
7	NC	-	No connect.
8	VDD	P	Power supply for the entire chip (3.3V)

Modulation Profile

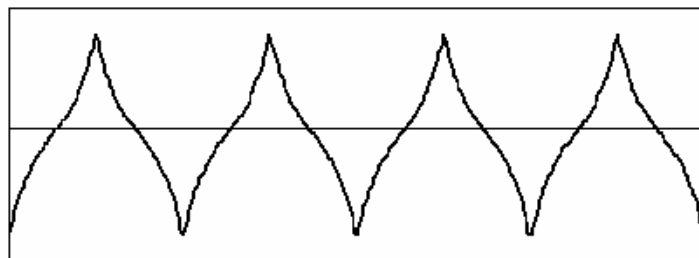

Specification

Description	Specification
Frequency Range	30MHz < CLKIN < 50MHz
Modulation Equation	$F_{IN}/1280$
Frequency Deviation	$\pm 0.75\%$



rev 2.0

Absolute Maximum Ratings

Symbol	Parameter	Rating	Unit
V_{DD}, V_{IN}	Voltage on any pin with respect to Ground	0.5 to +7.0	V
T_{STG}	Storage temperature	-65 to +125	°C
T_A	Operating temperature	0 to 70	°C

Note: These are stress ratings only and are not implied for functional use. Exposure to absolute maximum ratings for prolonged periods of time may affect device reliability.

DC Electrical Characteristics

(Test condition: All parameters are measured at room temperature (25°C) unless otherwise stated).

Symbol	Parameter	Min	Typ	Max	Unit
V_{IL}	Input low voltage	GND - 0.3	–	0.8	V
V_{IH}	Input high voltage	2.0	–	$V_{DD} + 0.3$	V
I_{IL}	Input low current	–	–	-35	μA
I_{IH}	Input high current	–	–	35	μA
I_{XOL}	XOUT output low current (@4.0V, $V_{DD}=3.3V$)	-	3	-	mA
I_{XOH}	XOUT output high current (@2.5V, $V_{DD}=3.3V$)	-	3	-	mA
V_{OL}	Output low voltage ($V_{DD} = 3.3 V, I_{OL} = 20 mA$)	–	–	0.4	V
V_{OH}	Output high voltage ($V_{DD} = 3.3 V, I_{OH} = 20 mA$)	2.5	–	–	V
I_{DD}	Static supply current*	–	–	1.5	mA
I_{PD}	Power-down current**	–	–	1.0	μA
I_{CC}	Dynamic supply current (3.3V, 50MHz and 15pF loading)	–	–	6	mA
V_{DD}	Operating voltage	3.0	3.3	3.6	V
t_{ON}	Power-up time (first locked cycle after power-up)***	–	–	10	mS
Z_{OUT}	Clock output impedance	–	50	–	Ω

* $\overline{XIN/CLKIN}$ pin is pulled low
 ** \overline{PD} pin is pulled low
 *** V_{DD} and $\overline{XIN/CLKIN}$ input are stable, \overline{PD} pin is made high from low.

AC Electrical Characteristics

Symbol	Parameter	Min	Typ	Max	Unit
CLKIN	Input frequency	30	-	50	MHz
ModOUT	Output frequency	30	-	50	MHz
t_{LH}^*	Output rise time (measured at 0.8V to 2.0V)	0.5	0.7	1.1	ns
t_{HL}^*	Output fall time (measured at 2.0V to 0.8V)	0.5	0.7	1.0	ns
t_{JC}	Jitter (cycle to cycle)	-	-	360	ps
t_D	Output duty cycle	45	50	55	%

* t_{LH} and t_{HL} are measured into a capacitive load of 15pF



Package Information

6-pin TSOT-23

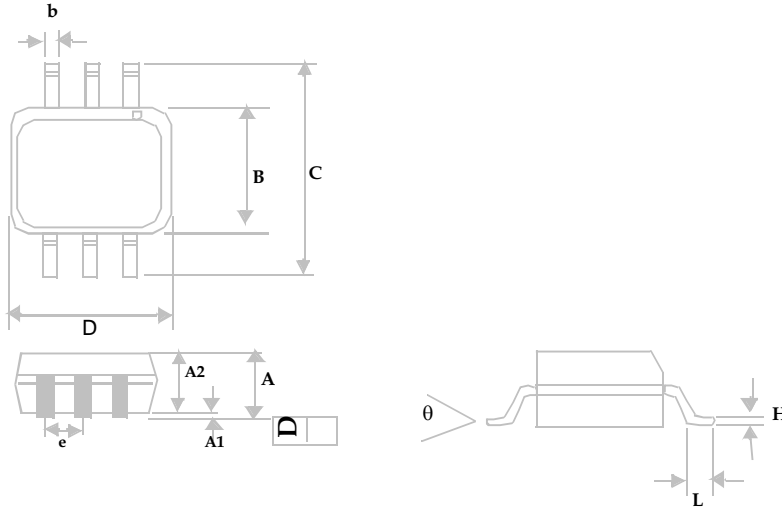

Symbol	Dimensions in millimeters		Dimensions in inches	
	Min	Max	Min	Max
A	-	1.00	-	0.040
A1	0	0.10	0	0.004
A2	0.87 REF		0.034 REF	
B	1.40	1.80	0.055	0.071
b	0.30	0.50	0.012	0.019
C	2.50	3.00	0.098	0.118
D	2.70	3.10	0.106	0.122
e	0.95 BSC		0.037 BSC	
H	0.10	0.35	0.004	0.014
L	MIN 0.20		MIN 0.008	
θ	0°	8°	0°	8°



8-Pin SOIC

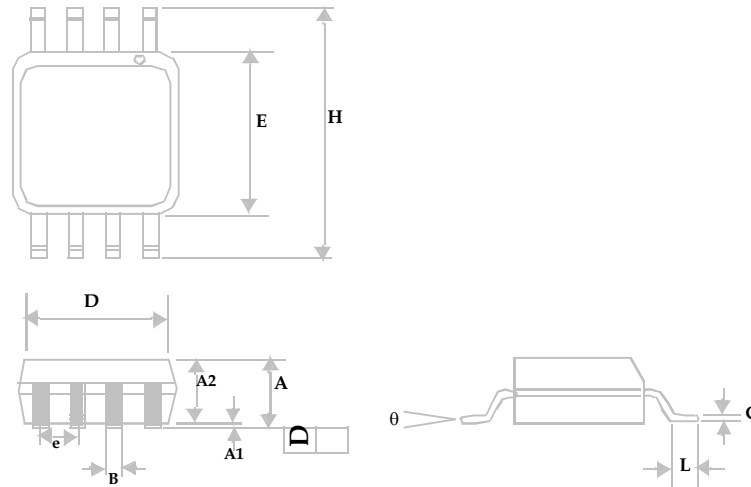

Symbol	Dimensions in inches		Dimensions in millimeters	
	Min	Max	Min	Max
A	0.057	0.071	1.45	1.80
A1	0.004	0.010	0.10	0.25
A2	0.053	0.069	1.35	1.75
B	0.012	0.020	0.31	0.51
C	0.004	0.01	0.10	0.25
D	0.186	0.202	4.72	5.12
E	0.148	0.164	3.75	4.15
e	0.050 BSC		1.27 BSC	
H	0.224	0.248	5.70	6.30
L	0.012	0.028	0.30	0.70
theta	0°	8°	0°	8°



8-Pin TSSOP

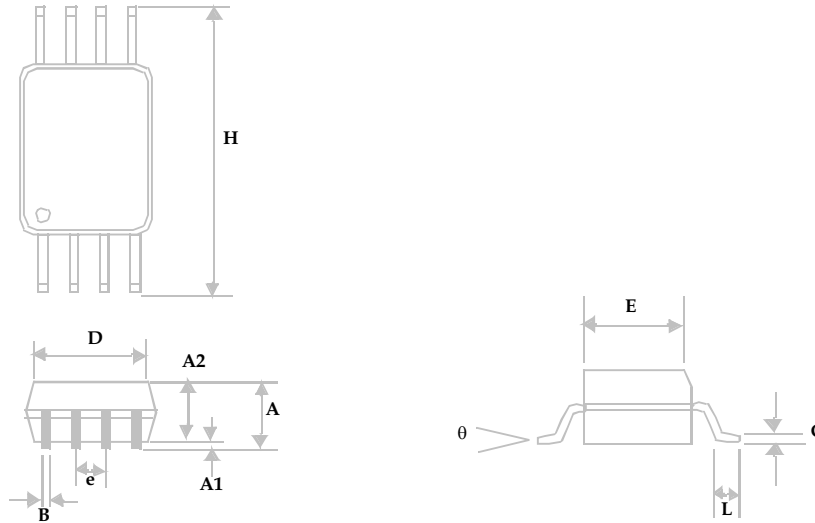

Symbol	Dimensions in inches		Dimensions in millimeters	
	Min	Max	Min	Max
A	0.047			1.10
A1	0.002	0.006	0.05	0.15
A2	0.031	0.041	0.80	1.05
B	0.007	0.012	0.19	0.30
C	0.004	0.008	0.09	0.20
D	0.114	0.122	2.90	3.10
E	0.169	0.177	4.30	4.50
e	0.026 BSC		0.65 BSC	
H	0.244	0.260	6.20	6.60
L	0.018	0.030	0.45	0.75
θ	0°	8°	0°	8°



Ordering Information

Part Number	Marking	Package Type	Temperature
ASM3P2780AF-06OR	G4LL	6-Pin TSOT-23, TAPE & REEL	0°C – 70°C
ASM3P2780AF-08TT	ASM3P2780AFT	8-Pin TSSOP, TUBE	0°C – 70°C
ASM3P2780AF-08TR	ASM3P2780AFT	8-Pin TSSOP, TAPE & REEL	0°C – 70°C
ASM3P2780AF-08ST	ASM3P2780AFS	8-Pin SOIC, TUBE	0°C – 70°C
ASM3P2780AF-08SR	ASM3P2780AFS	8-Pin SOIC, TAPE & REEL	0°C – 70°C
ASM3P2780A-06OR	G1LL	6-Pin TSOT-23, TAPE & REEL	0°C – 70°C
ASM3P2780A-08TT	ASM3P2780AT	8-Pin TSSOP, TUBE	0°C – 70°C
ASM3P2780A-08TR	ASM3P2780AT	8-Pin TSSOP, TAPE & REEL	0°C – 70°C
ASM3P2780A-08ST	ASM3P2780AS	8-Pin SOIC, TUBE	0°C – 70°C
ASM3P2780A-08SR	ASM3P2780AS	8-Pin SOIC, TAPE & REEL	0°C – 70°C

Device Ordering Information

A S M 3 P 2 7 8 0 A F - 0 8 T R

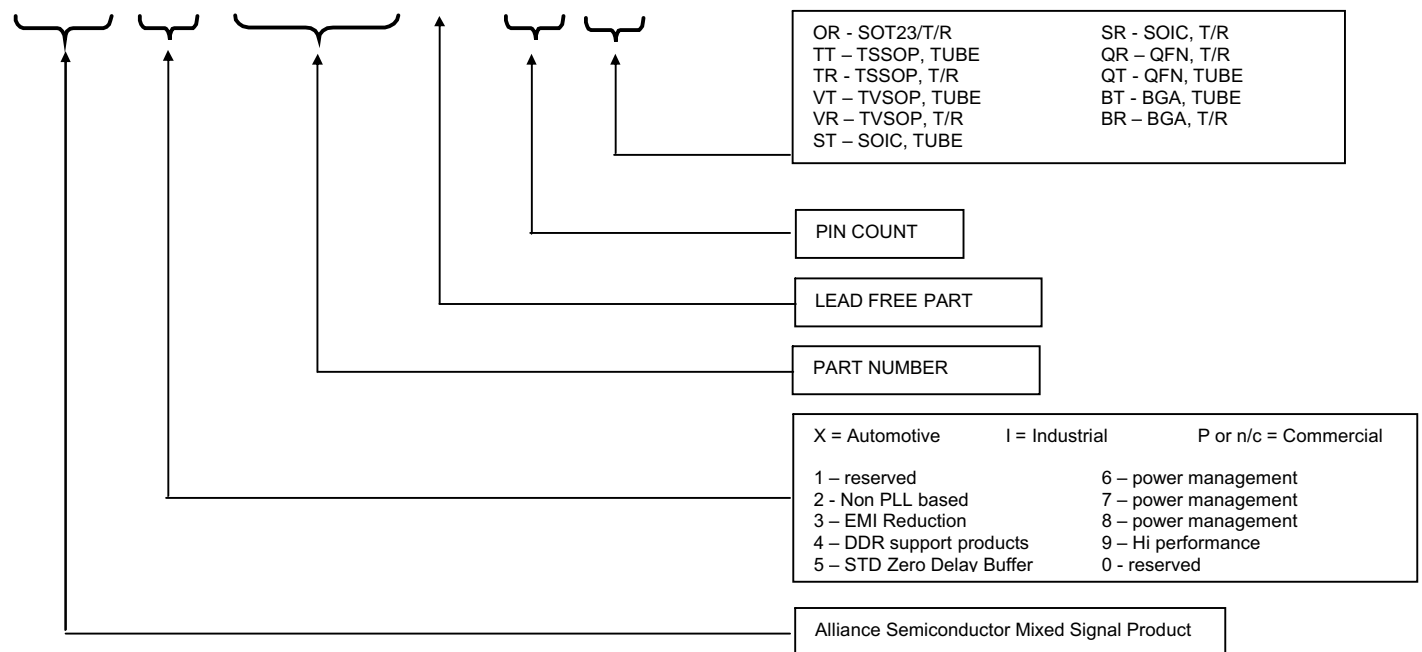

Licensed under U.S Patent Nos 5,488,627 and 5,631,921



Alliance Semiconductor Corporation
2595, Augustine Drive,
Santa Clara, CA 95054
Tel# 408-855-4900
Fax: 408-855-4999
www.alsc.com

Copyright © Alliance Semiconductor
All Rights Reserved
Preliminary Information
Part Number: ASM3P2780A
Document Version: v 2.0 8_30_2004

Note: This product utilizes US Patent # 6,646,463 Impedance Emulator Patent issued to Alliance Semiconductor, dated 11-11-2003

© Copyright 2003 Alliance Semiconductor Corporation. All rights reserved. Our three-point logo, our name and Intelliwatt are trademarks or registered trademarks of Alliance. All other brand and product names may be the trademarks of their respective companies. Alliance reserves the right to make changes to this document and its products at any time without notice. Alliance assumes no responsibility for any errors that may appear in this document. The data contained herein represents Alliance's best data and/or estimates at the time of issuance. Alliance reserves the right to change or correct this data at any time, without notice. If the product described herein is under development, significant changes to these specifications are possible. The information in this product data sheet is intended to be general descriptive information for potential customers and users, and is not intended to operate as, or provide, any guarantee or warranty to any user or customer. Alliance does not assume any responsibility or liability arising out of the application or use of any product described herein, and disclaims any express or implied warranties related to the sale and/or use of Alliance products including liability or warranties related to fitness for a particular purpose, merchantability, or infringement of any intellectual property rights, except as express agreed to in Alliance's Terms and Conditions of Sale (which are available from Alliance). All sales of Alliance products are made exclusively according to Alliance's Terms and Conditions of Sale. The purchase of products from Alliance does not convey a license under any patent rights, copyrights; mask works rights, trademarks, or any other intellectual property rights of Alliance or third parties. Alliance does not authorize its products for use as critical components in life-supporting systems where a malfunction or failure may reasonably be expected to result in significant injury to the user, and the inclusion of Alliance products in such life-supporting systems implies that the manufacturer assumes all risk of such use and agrees to indemnify Alliance against all claims arising from such use.