Radar Sensor Switch Control

**Revision History**

Version	Date	Changes
V1.00	Sep.30, 2011	1 ^{st.} Edition
V2.00	Mar.08, 2012	2 ^{nd.} Edition

Index

➤ Important notice	3
➤ Declaration.....	3
➤ Warranty.....	3
➤ Contact us.....	3
➤ Overview.....	4
➤ Special Feature.....	4
➤ Application.....	4
➤ Specifications.....	5
➤ Detail Diagram.....	5
➤ Wiring.....	6
➤ Installation.....	6
➤ Switch Control Diagram.....	7
➤ Light Indicator	8
➤ Delay Switch Control.....	8

Important Event

- This product is in general use for the equipment on the premise of the development, design, manufacture. Do not use that require high security purposes, such as machinery or medical, aviation equipment, machinery and transport-related deaths are directly or indirectly related to the system.
- This product should be in this brochure by the instructions of the types and rated voltage power under the current proper use. If violation of this statement by the safety records of the supply operation, I am afraid our company cannot afford any of the responsibility.
- Do not self-decomposition, alteration, repair of the products also will cause fire, electric shock, fault, and dangerous. In addition, their decomposition, alteration, repair the product, failure is not within the scope of warranty.
- The products are not waterproof, so please do not use and touch water. Take off and on also please note. Rain, spray, drinks, steam, sweat may be a failure.
- Use of this product, please be sure to use according to the statement recorded by the use of methods to operate. Please do not violate particular attention to the matter reminded to use.
- Please respect this statement recorded by the note. When consumers in contravention of this statement recorded note of the operation, I am afraid our company could not shoulder any responsibility.
- Products are defective, the Company will be responsible for free to amend the flaws, or to the same flawless product or its equivalent products in exchange. However, the Company does not assume based on the requirements of the flaw and loss responsibility.
- The Company reserves the right to retain without notice to users of the cases, the product of hardware / software (version upgrade) is with the right to edit.

Declaration

This product provides different frequency for user selection to meet different telecommunication regulation and FCC/CE on different countries.

Warranty

The warranty time is within one year from purchased date. The warranty scope are used in normal situation and none vandalism. (Some function harmful out of warranty scope and Vandalism are Un-warranty).

Un-warranty Scope Description

- Because the natural disaster, accident or human factor to cause the bad damage.
- Violate the product instruction manual to cause the damage of the products.
- The improper assemble causes damage.
- The products used the unsanctioned accessory to cause damaged.
- Overstep the allowed used environment to cause the products damaged.

Contact Us

WENSHING ELECTRONICS CO., LTD.
No.82, Chong De St. 11054 Shin Yi District, Taipei, Taiwan
Tel: +886-2-27353055
Fax: +886-2-27328813

Overview

8.5GHz Radar sensor switch control utilizes Doppler radar sensor technology for switch control, based on Doppler Effect and uses the pioneering flat antenna effectively suppressed signal's higher waves and other sources of interference. When personnel enters sensor range Radar Sensor Switch Control detects changes in body movement and automatically connects the power source, as long as there is someone with in its sensor range power will stay connected; Once personal leaves the room and out of sensor range it will automatically disconnects the power. The 8.5GHz Radar sensor switch control is eco-friendly, energy efficient and decreases your energy bill.

Special Feature

- Patented Technology
- Night light, manual and automatic control.
- Unique hand motion detection switch.
- Automatically switch on when night falls.
- Simple switch on/off without sensor, convenient for office use.
- Wireless high frequency microwave detection to avoid PIR misreading due to weather, temperature and causing mal-function and undesirable effects.
- Lowered passive infrared detection misreading rate.
- Maximum effective range : 10m

Application

- Automatically lighting
- Stairway lighting
- Outdoor lawn light
- Parking lot light control
- Traffic sign control
- Office lighting management
- Security camera lighting control

Specification

- Voltage range : 24Vac~220Vac
- Maximum load : 240Vac 10A

Detail Diagram

- ① : Sensor manual switch
- ② : Status indicator light
- ③ : Range adjustment switch
- ④ : Mode adjustment dip switch

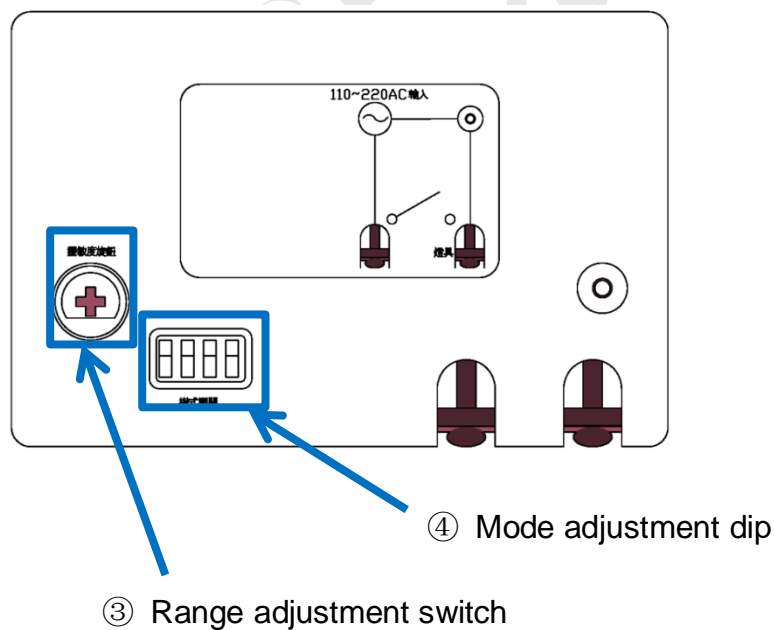
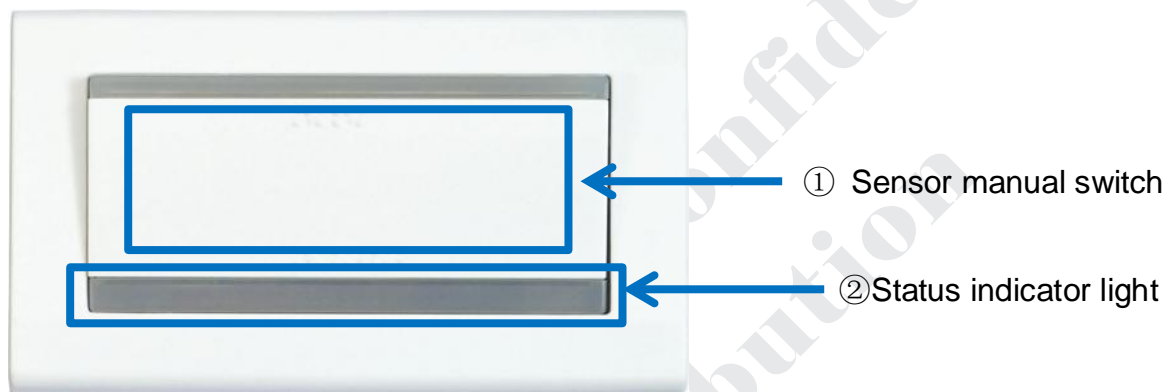

Wiring

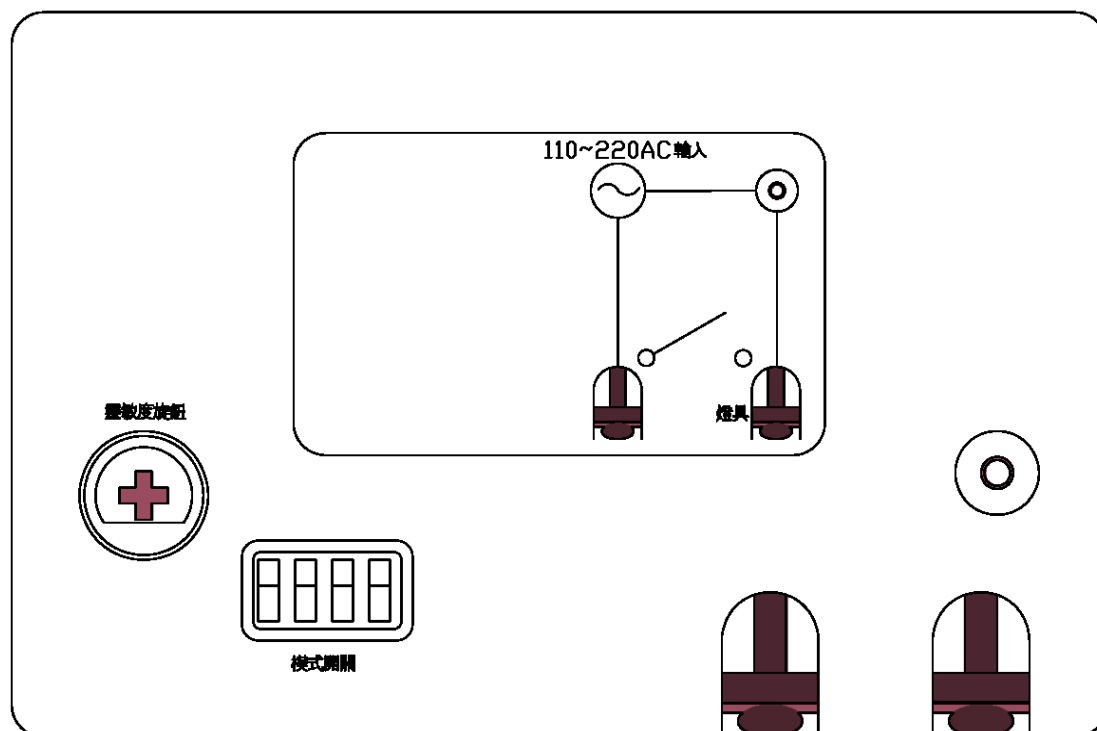

Installation

1. Connect lamp holder and power according to the wiring diagram.
2. Set mode adjustment dip switch to daylight or night mode. (User can select which mode to use according to their needs).
3. Adjust off timer delay to the requirement length. (User can select which mode to use according to their needs).
4. Fix in to the wall and turn on the power, the product will enter self-evaluation mode, test and adjust sensor. It will take approximately 15secs to complete. Please do not move about or have any moving object in the room at the time. (It will affect the accuracy of product self-adjustment) .
5. System will work properly once the indicator light indicates normal. (Please refer the indicator light status chart).

Mode setting dip switch

Day Mode : 10XX

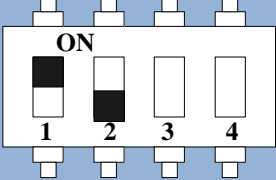

- **Day : Blue light will stay on**
 - Manual switch only ◦
 - Blue light turns on when manually switched on, automatically turns off in 8 hours if not turned off manually.
- **Night : Green indicator light remain lit when no motion is detected, when motion is detected the green indicator light turns off.**
 - Green indicator light remain lit when no motion is detected ◦
 - When motion is detected , the product will automatically turn on (Green indicator light will be off at this time) and begin count down on the delay switch for a few minutes. During this time if no motion is detected the light will automatically switch off if motion is detected then it will restart on the count down on the delay switch, until no motion is detected.
 - When manually switched on the green indicator light begin to flash, if not manually switched off it will automatically turn off after 8 hours.

Night Mode : 01XX

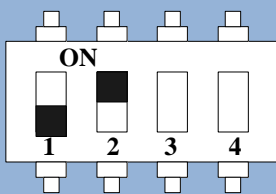

- **Day : When no motion is detected the blue light will remain lit; when motion is detected the blue light will dim.**
- When no motion is detected, the blue light will remain lit.
- When motion is detected the product will automatically turn on the lights (during this time the blue indicator light dims) and began count down for a few minute, During this time if no motion is detected the light will automatically switch off if motion is detected then it will restart on the count down on the delay switch, until no motion is detected.
- When manually switched on the blue indicator light will begin to flash, if not switch off manually, it will automatically switch off after 8 hours.
- **Night : When no motion is detected the green indicator light will remain lit; when motion is detected the green indicator light will dim.**
- When no motion is detected the green indicator light will remain lit.
- When motion is detected the light will switch on automatically, (green indicator light will dim at this time) and begin count down on the delay switch. During this time if no motion is detected the light will automatically switch off if motion is detected then it will restart on the count down on the delay switch, until no motion is detected.
- When manually switched on the green indicator light will begin to flash. If not manually switched of it will automatically switch off in 8 hours.

Indicator light chart

Day Mode	Blue LED	Green LED
Day time No motion	Lit	Off
Day time with motion	Lit	Off
Day time manually switched	Flash	Off
Night time no motion	Off	Lit
Night time with motion	Off	Off
Night time manually switched	Off	Flash

Night Mode	Blue LED	Green LED
Day time No motion	Lit	Off
Day time with motion	Off	Off
Day time manually switched	Flash	Off
Night time no motion	Off	Lit
Night time with motion	Off	Off
Night time manually switched	Off	Flash

Delay off setting

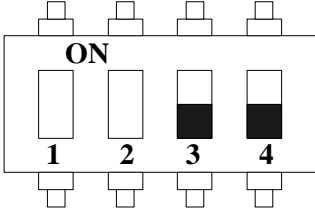
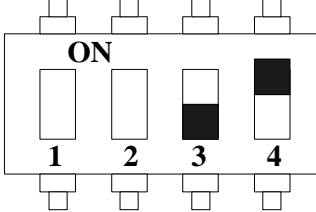
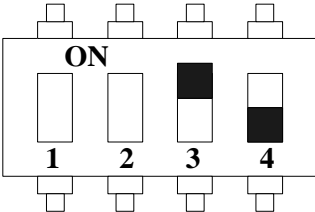
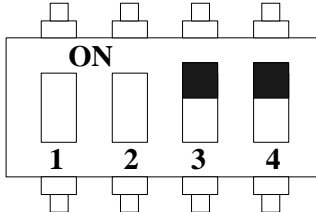
4 minutes delay	16 minutes delay
	
32 minutes delay	64 minutes delay
	

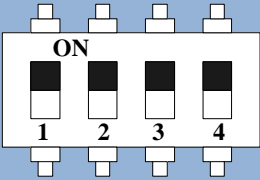
<p>Testing Mode : 1111</p> 	<p>When turned on, the indicator light will be lit from right to left in the order of blue→ red→ yellow→ green. After 10 cycles the red light will remain lit, once motion is detected the light will switch for 1 second. (Blue indicator light will turn on for 1 second and then off.)</p>
---	---

**Sensitivity Adjustment
mode : 1110**

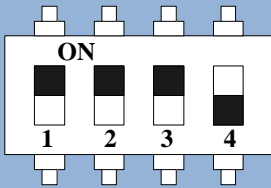

When turned on, the indicator light will be lit from right to left in the order of blue→ red→ yellow→ green. After 10 cycles the yellow light will remain lit. If no motion is detected within 5 seconds, the product will automatically adjust and save sensitivity setting and automatically turns on the lights (Blue indicator light will dim automatically within 5 seconds). The Radar Sensor Switch Control continues to sense motion at this time, once motion is detected it will turn on the lights for 1 second (blue indicator light will lit for 1 second and the dim after) during this mode the user can test the signal coverage and adjust the range setting accordingly after setting is completed the user can then switch between day mode or night mode as needed.)