

**SURFACE MOUNT GLASS PASSIVATED
SUPER FAST SILICON RECTIFIER**
VOLTAGE RANGE 50 to 200 Volts CURRENT 1.0 Ampere

FEATURES

- * Glass passivated device
- * For surface mounted applications
- * Ultrafast recovery times dor high efficiency
- * Low forward voltage, low power loss
- * Low leakage current

MECHANICAL DATA

- * Epoxy: Device has UL flammability classification 94V-O
- * Metallurgically bonded construction
- * Mounting position: Any
- * Weight: 0.016 gram

NEW RELEASE

SOD-123FL

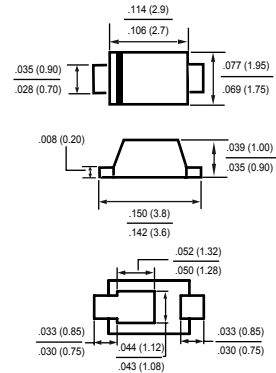

Dimensions in inches and (millimeters)

MAXIMUM RATINGS AND ELECTRICAL CHARACTERISTICS

Ratings at 25 °C ambient temperature unless otherwise specified.
Single phase, half wave, 60 Hz, resistive or inductive load.
For capacitive load, derate current by 20%.

MAXIMUM RATINGS (@ TA=25 °C unless otherwise noted)

RATINGS	SYMBOL	SU1L	SU2L	SU3L	SU4L	UNITS
Maximum Recurrent Peak Reverse Voltage	V_{RRM}	50	100	150	200	Volts
Maximum RMS Voltage	V_{RMS}	35	70	105	140	Volts
Maximum DC Blocking Voltage	V_{DC}	50	100	150	200	Volts
Maximum Average Forward Rectified Current at $T_A = 55^\circ\text{C}$	I_O	1.0				Amps
Peak Forward Surge Current 8.3 ms single half sine-wave superimposed on rated load (JEDEC method)	I_{FSM}	20				Amps
Typical Thermal Resistance (Note 1)	$R_{\theta JA}$	120				$^\circ\text{C}/\text{W}$
Typical Thermal Resistance (Note 1)	$R_{\theta JL}$	20				$^\circ\text{C}/\text{W}$
Typical Junction Capacitance (Note 2)	C_J	18				pF
Operating Temperature Range	T_J	150				$^\circ\text{C}$
Storage Temperature Range	T_{STG}	-55 to + 150				$^\circ\text{C}$

ELECTRICAL CHARACTERISTICS (@TA=25 °C unless otherwise noted)

CHARACTERISTICS	SYMBOL	SU1L	SU2L	SU3L	SU4L	UNITS
Maximum Instantaneous Forward Voltage at 1.0A DC	V_F	0.95				Volts
Maximum Average Reverse Current at Rated DC Blocking Voltage	@ $T_A = 25^\circ\text{C}$	5				μA
	@ $T_A = 100^\circ\text{C}$	350				μA
Maximum Reverse Recovery Time (Note 4)	t_{rr}	20				nSec

- NOTES : 1. Thermal Resistance :Mounted on PCB.
2. Measured at 1 MHz and applied reverse voltage of 4.0 volts.
3. "Fully ROHS compliant", "100% Sn plating (Pb-free)".
4. Test Conditions: $I_F = 0.5\text{A}$, $I_R = -1.0\text{A}$, $I_{RR} = -0.25\text{A}$.

RATING AND CHARACTERISTICS CURVES (SU1L THRU SU4L)

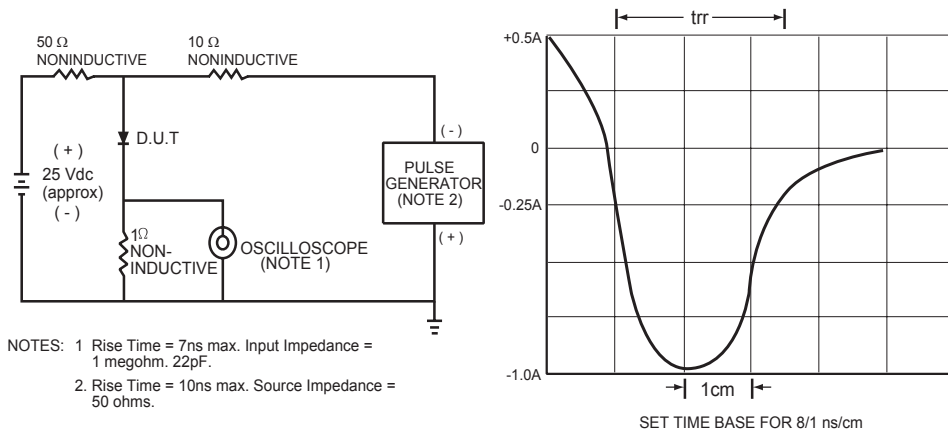

FIG.1 TEST CIRCUIT DIAGRAM AND REVERSE RECOVERY TIME CHARACTERISTIC

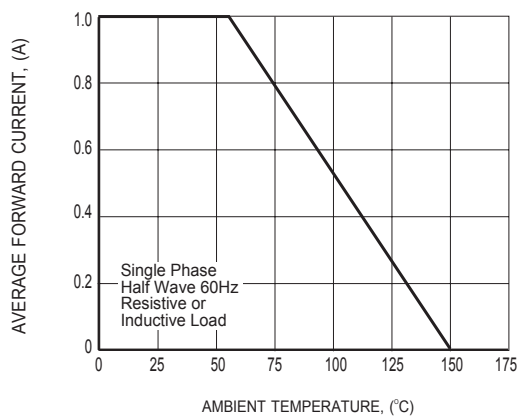

FIG.2 TYPICAL FORWARD CURRENT DERATING CURVE

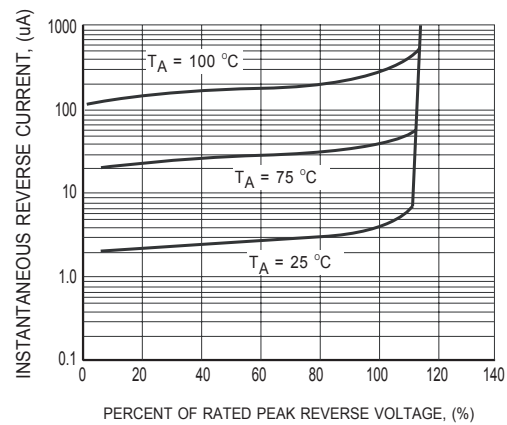

FIG.3 TYPICAL REVERSE CHARACTERISTICS

RATING AND CHARACTERISTICS CURVES (SU1L THRU SU4L)

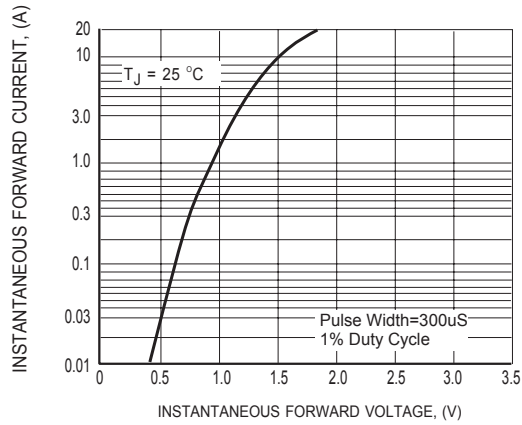

FIG.4 TYPICAL INSTANTANEOUS FORWARD CHARACTERISTICS

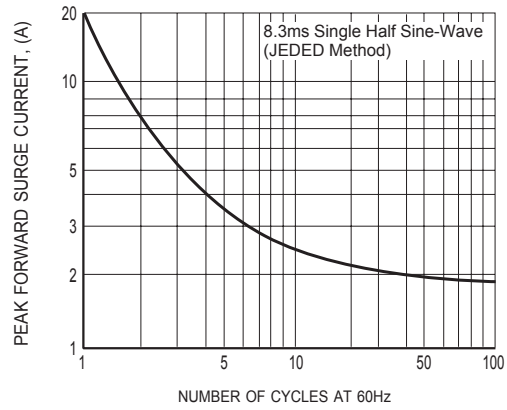

FIG.5 MAXIMUM NON-REPETITIVE FORWARD SURGE CURRENT

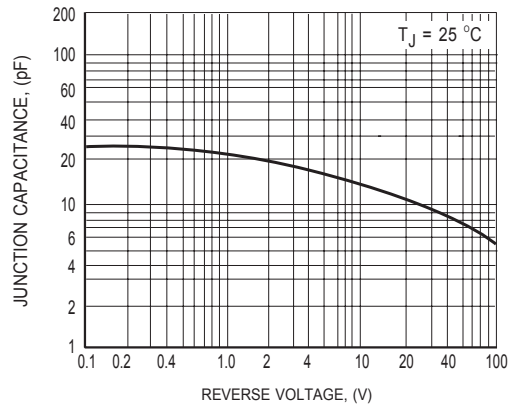
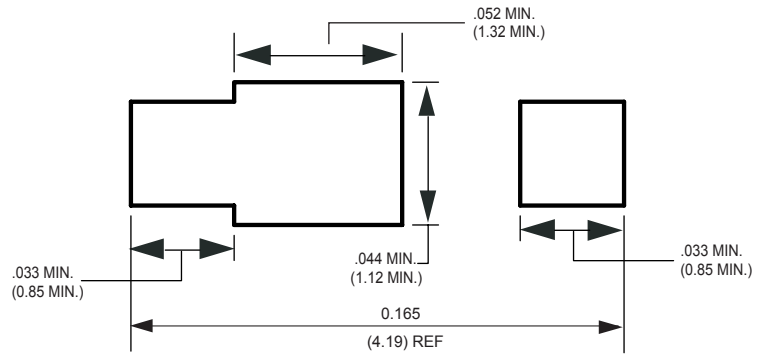

FIG.6 TYPICAL JUNCTION CAPACITANCE

Mounting Pad Layout



Dimensions in inches and (millimeters)

DISCLAIMER NOTICE

Rectron Inc reserves the right to make changes without notice to any product specification herein, to make corrections, modifications, enhancements or other changes. Rectron Inc or anyone on its behalf assumes no responsibility or liability for any errors or inaccuracies. Data sheet specifications and its information contained are intended to provide a product description only. "Typical" parameters which may be included on RECTRON data sheets and/ or specifications can and do vary in different applications and actual performance may vary over time. Rectron Inc does not assume any liability arising out of the application or use of any product or circuit.

Rectron products are not designed, intended or authorized for use in medical, life-saving implant or other applications intended for life-sustaining or other related applications where a failure or malfunction of component or circuitry may directly or indirectly cause injury or threaten a life without expressed written approval of Rectron Inc. Customers using or selling Rectron components for use in such applications do so at their own risk and shall agree to fully indemnify Rectron Inc and its subsidiaries harmless against all claims, damages and expenditures.