



STN4NF06L

N-channel 60 V, 0.07 Ω , 4 A SOT-223
STripFET™ II Power MOSFET

Features

Order code	V _{DSS}	R _{DS(on)} max	I _D
STN4NF06L	60 V	< 0.1 Ω	4 A

- Exceptional dv/dt capability
- Avalanche rugged technology
- 100% avalanche tested
- Low threshold drive

Applications

- Switching application
 - Automotive

Description

This device is a N-channel STripFET™ II Power MOSFET that is the latest development of STMicroelectronics unique “single feature size” strip-based process. The resulting transistor shows extremely high packing density for low on-resistance, rugged avalanche characteristics and less critical alignment steps therefore a remarkable manufacturing reproducibility.

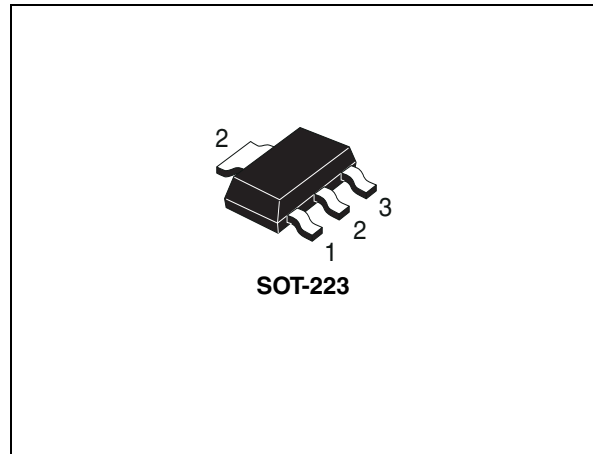

Figure 1. Internal schematic diagram



Table 1. Device summary

Order code	Marking	Package	Packaging
STN4NF06L	4NF06L	SOT-223	Tape and reel

Contents

1	Electrical ratings	3
2	Electrical characteristics	4
	2.1 Electrical characteristics (curves)	6
3	Test circuit	8
4	Package mechanical data	9
5	Revision history	11

1 Electrical ratings

Table 2. Absolute maximum ratings

Symbol	Parameter	Value	Unit
V_{DS}	Drain-source voltage ($V_{GS} = 0$)	60	V
V_{GS}	Gate-source voltage	± 16	V
$I_D^{(1)}$	Drain current (continuous) at $T_C = 25\text{ }^\circ\text{C}$	4	A
I_D	Drain current (continuous) at $T_C=100\text{ }^\circ\text{C}$	2.9	A
$I_{DM}^{(2)}$	Drain current (pulsed)	16	A
P_{TOT}	Total dissipation at $T_C = 25\text{ }^\circ\text{C}$	3.3	W
	Derating factor	0.026	W/ $^\circ\text{C}$
$dv/dt^{(3)}$	Peak diode recovery voltage slope	10	V/ns
$E_{AS}^{(4)}$	Single pulse avalanche energy	200	mJ
T_J T_{stg}	Operating junction temperature Storage temperature	-55 to 150	$^\circ\text{C}$

1. Current limited by the package.
2. Pulse width limited by safe operating area.
3. $I_{SD} \leq 3\text{ A}$, $di/dt \leq 150\text{ A}/\mu\text{s}$, $V_{DD} \leq V_{(BR)DSS}$, $T_J \leq T_{JMAX}$.
4. Starting $T_J = 25\text{ }^\circ\text{C}$, $I_D = 4\text{ A}$, $V_{DD} = 30\text{ V}$.

Table 3. Thermal data

Symbol	Parameter	Value	Unit
$R_{thj-pcb}^{(1)}$	Thermal resistance junction-PCB max.	38	$^\circ\text{C}/\text{W}$
$R_{thj-pcb}^{(2)}$	Thermal resistance junction-PCB max.	100	$^\circ\text{C}/\text{W}$
$T_1^{(3)}$	Maximum lead temperature for soldering purpose typ.	260	$^\circ\text{C}$

1. When Mounted on FR-4 board with 1 inch² pad, 2 oz. of Cu. and $t < 10\text{ sec}$.
2. When mounted on minimum recommended footprint.
3. For 10 sec. 1.6 mm from case.

2 Electrical characteristics

($T_{CASE} = 25\text{ °C}$ unless otherwise specified)

Table 4. On/off states

Symbol	Parameter	Test conditions	Min.	Typ.	Max.	Unit
$V_{(BR)DSS}$	Drain-source breakdown voltage	$I_D = 250\ \mu\text{A}$, $V_{GS} = 0$	60			V
I_{DSS}	Zero gate voltage drain current ($V_{GS} = 0$)	$V_{DS} = \text{Max rating}$, $V_{DS} = \text{Max rating @ } 125\text{ °C}$			1 10	μA μA
I_{GSS}	Gate body leakage current ($V_{DS} = 0$)	$V_{GS} = \pm 16\text{ V}$			± 100	nA
$V_{GS(th)}$	Gate threshold voltage	$V_{DS} = V_{GS}$, $I_D = 250\ \mu\text{A}$	1		2.8	V
$R_{DS(on)}$	Static drain-source on resistance	$V_{GS} = 10\text{ V}$, $I_D = 1.5\text{ A}$ $V_{GS} = 5\text{ V}$, $I_D = 1.5\text{ A}$		0.07 0.085	0.10 0.12	Ω Ω

Table 5. Dynamic

Symbol	Parameter	Test conditions	Min.	Typ.	Max.	Unit
$g_{fs}^{(1)}$	Forward transconductance	$V_{DS} = 15\text{ V}$, $I_D = 1.5\text{ A}$	-	3		S
C_{iss}	Input capacitance	$V_{DS} = 25\text{ V}$, $f = 1\text{ MHz}$, $V_{GS} = 0$	-	340		pF
C_{oss}	Output capacitance			63		pF
C_{rss}	Reverse transfer capacitance			30		pF
Q_g	Total gate charge	$V_{DD} = 48\text{ V}$, $I_D = 3\text{ A}$	-	7	9	nC
Q_{gs}	Gate-source charge	$V_{GS} = 5\text{ V}$		1.5		nC
Q_{gd}	Gate-drain charge	(see Figure 15)		2.8		nC

1. Pulsed: pulse duration=300 μs , duty cycle 1.5%

Table 6. Switching times

Symbol	Parameter	Test conditions	Min.	Typ.	Max.	Unit
$t_{d(on)}$	Turn-on delay time rise time	$V_{DD} = 30\text{ V}$, $I_D = 1.5\text{ A}$, $R_G = 4.7\ \Omega$, $V_{GS} = 5\text{ V}$ (see Figure 14)	-	9	-	ns
t_r				25		
$t_{d(off)}$	Turn-off delay time fall time	$V_{DD} = 30\text{ V}$, $I_D = 1.5\text{ A}$, $R_G = 4.7\ \Omega$, $V_{GS} = 5\text{ V}$ (see Figure 14)	-	20	-	ns
t_f				10		

Table 7. Source drain diode

Symbol	Parameter	Test conditions	Min.	Typ.	Max	Unit
I_{SD}	Source-drain current		-		4	A
$I_{SDM}^{(1)}$	Source-drain current (pulsed)		-		16	A
$V_{SD}^{(2)}$	Forward on voltage	$I_{SD}= 4\text{ A}, V_{GS}=0$	-		1.5	V
t_{rr}	Reverse recovery time	$I_{SD}= 4\text{ A},$ $di/dt = 100\text{ A}/\mu\text{s},$ $V_{DD}= 25\text{ V}, T_j= 150\text{ }^\circ\text{C}$ <i>(see Figure 16)</i>	-	50		ns
Q_{rr}	Reverse recovery charge			88		nC
I_{RRM}	Reverse recovery current			3.5		A

1. Pulse width limited by safe operating area.
2. Pulsed: pulse duration= 300 μs , duty cycle 1.5%

2.1 Electrical characteristics (curves)

Figure 2. Safe operating area

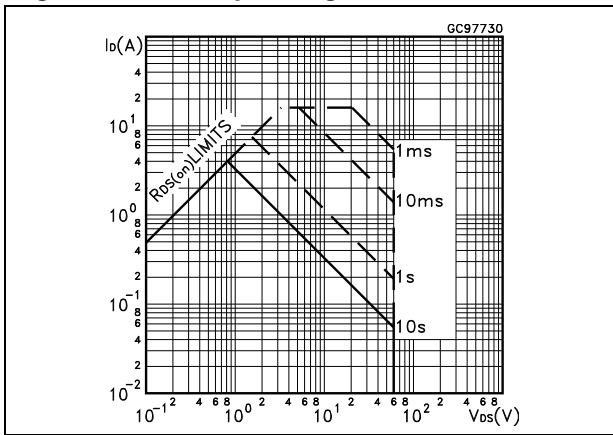

Figure 3. Thermal impedance

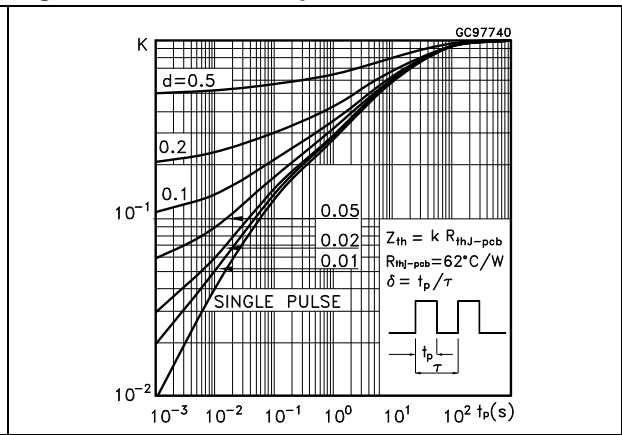

Figure 4. Output characteristics

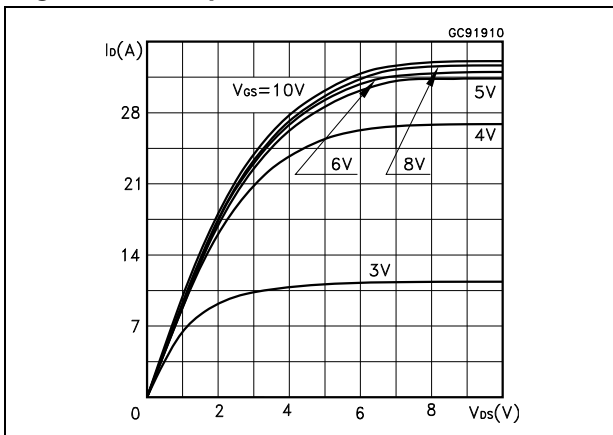

Figure 5. Transfer characteristics

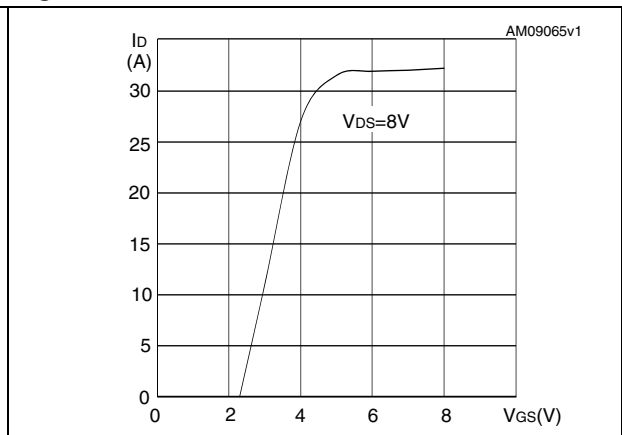

Figure 6. Transconductance

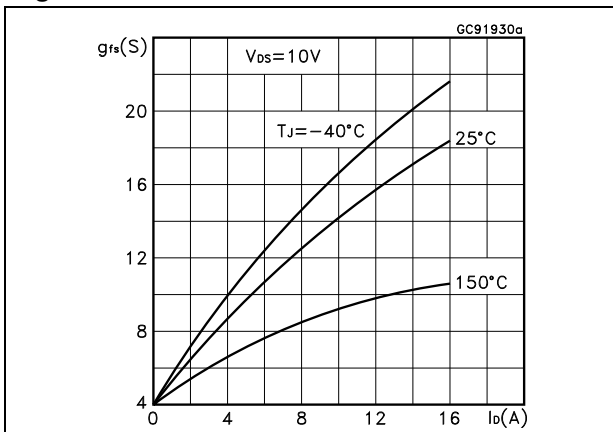

Figure 7. Static drain-source on resistance

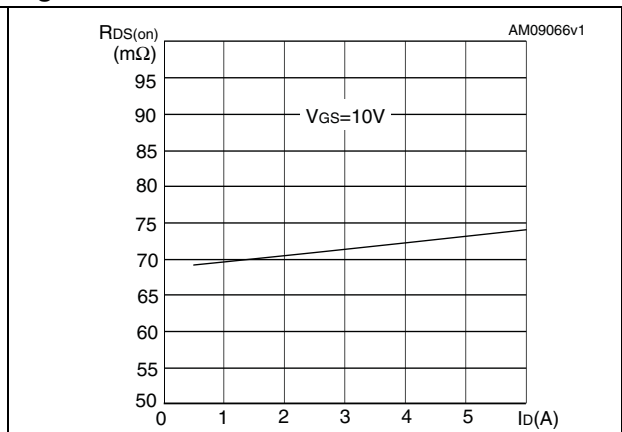

Figure 8. Gate charge vs. gate-source voltage Figure 9. Capacitance variations

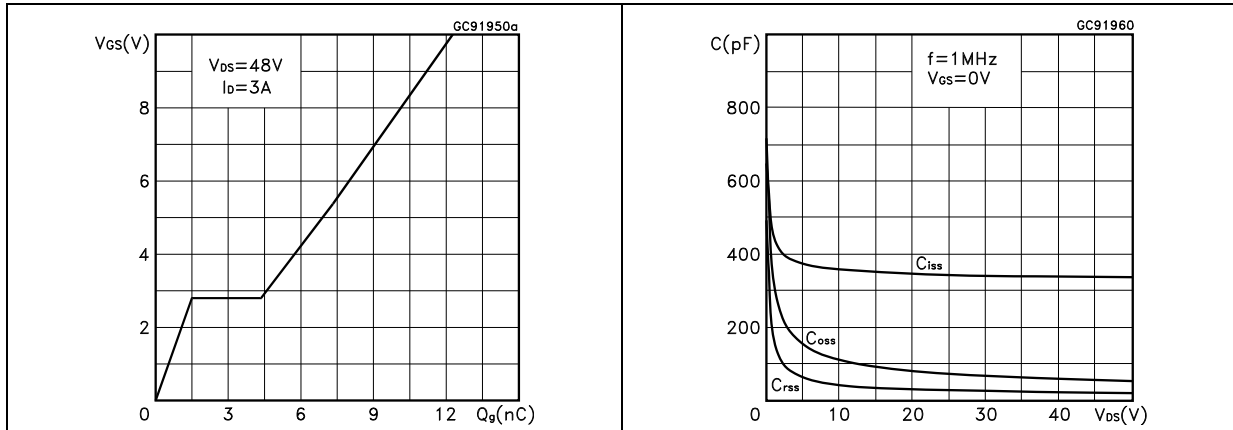

Figure 10. Normalized gate threshold voltage vs. temperature

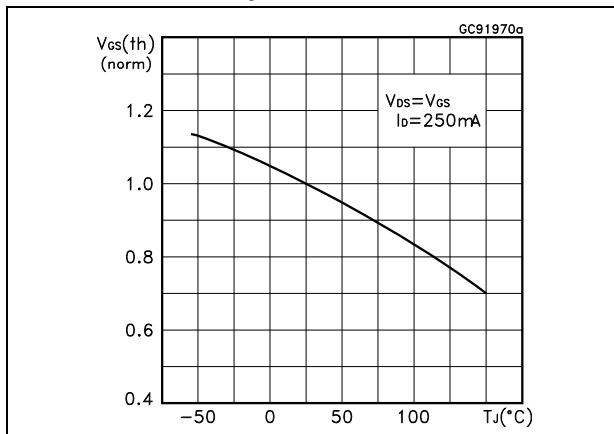

Figure 11. Normalized on resistance vs. temperature

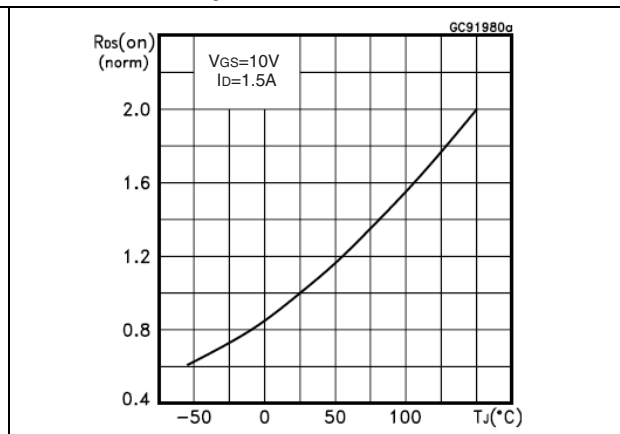

Figure 12. Source-drain diode forward characteristics

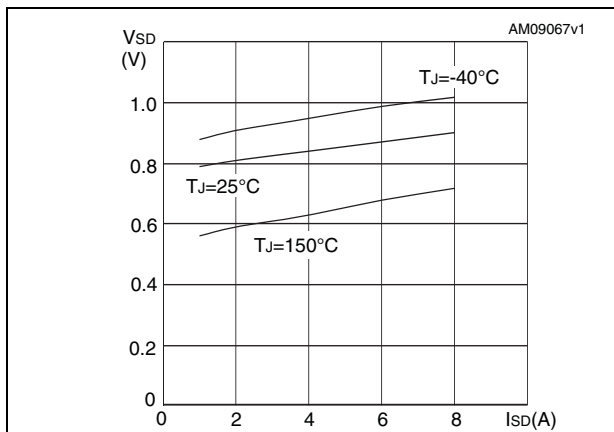
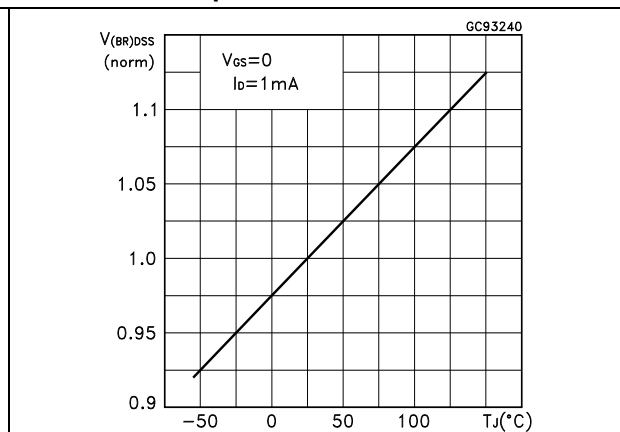

Figure 13. Normalized breakdown voltage vs. temperature



3 Test circuit

Figure 14. Switching times test circuit for resistive load



Figure 15. Gate charge test circuit



Figure 16. Test circuit for inductive load switching and diode recovery times

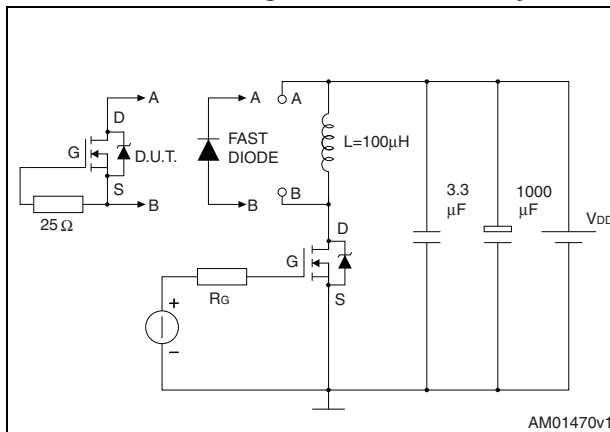

Figure 17. Unclamped Inductive load test circuit

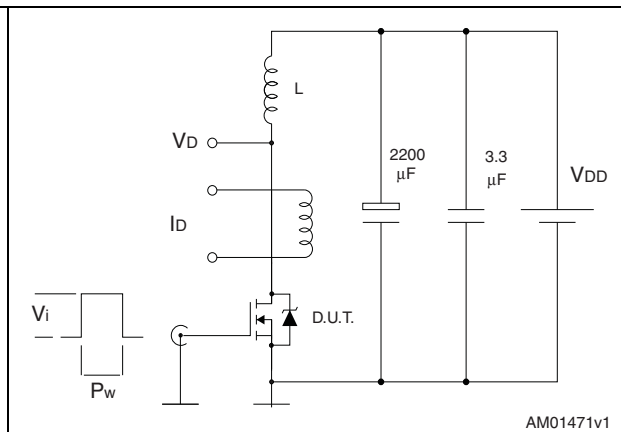

Figure 18. Unclamped inductive waveform

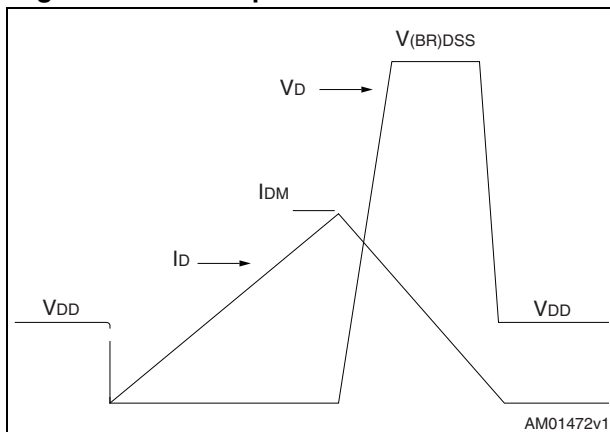
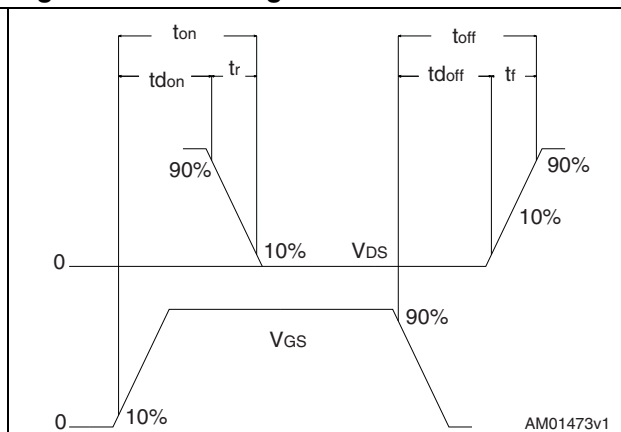

Figure 19. Switching time waveform



4 Package mechanical data

In order to meet environmental requirements, ST offers these devices in different grades of ECOPACK® packages, depending on their level of environmental compliance. ECOPACK® specifications, grade definitions and product status are available at: www.st.com. ECOPACK is an ST trademark.

Table 8. SOT-223 mechanical data

Dim.	mm		
	Min.	Typ.	Max.
a	2.27	2.3	2.33
b	4.57	4.6	4.63
c	0.2	0.4	0.6
d	0.63	0.65	0.67
e1	1.5	1.6	1.7
e4			0.32
f	2.9	3	3.1
g	0.67	0.7	0.73
l1	6.7	7	7.3
l2	3.5	3.5	3.7
L	6.3	6.5	6.7

Figure 20. SOT-223 mechanical data drawing

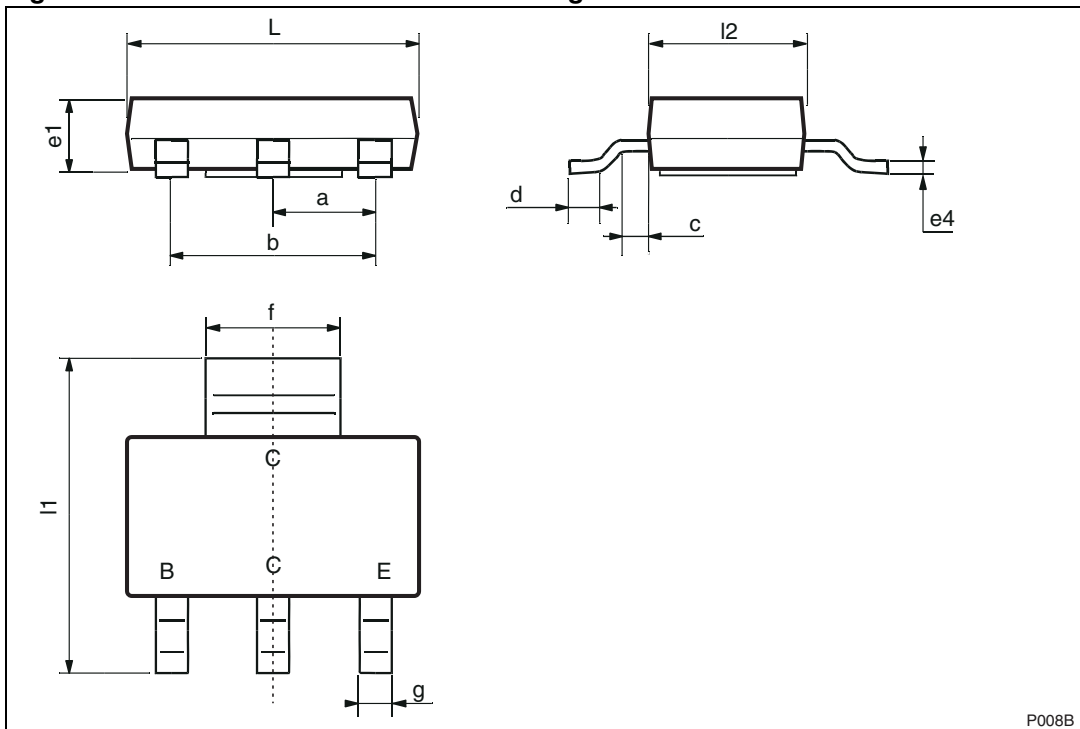

P008B

5 Revision history

Table 9. Document revision history

Date	Revision	Changes
22-Apr-2008	1	Initial version.
29-Apr-2011	2	<i>Figure 5, Figure 7, Figure 11 and Figure 12</i> have been updated.

Please Read Carefully:

Information in this document is provided solely in connection with ST products. STMicroelectronics NV and its subsidiaries ("ST") reserve the right to make changes, corrections, modifications or improvements, to this document, and the products and services described herein at any time, without notice.

All ST products are sold pursuant to ST's terms and conditions of sale.

Purchasers are solely responsible for the choice, selection and use of the ST products and services described herein, and ST assumes no liability whatsoever relating to the choice, selection or use of the ST products and services described herein.

No license, express or implied, by estoppel or otherwise, to any intellectual property rights is granted under this document. If any part of this document refers to any third party products or services it shall not be deemed a license grant by ST for the use of such third party products or services, or any intellectual property contained therein or considered as a warranty covering the use in any manner whatsoever of such third party products or services or any intellectual property contained therein.

UNLESS OTHERWISE SET FORTH IN ST'S TERMS AND CONDITIONS OF SALE ST DISCLAIMS ANY EXPRESS OR IMPLIED WARRANTY WITH RESPECT TO THE USE AND/OR SALE OF ST PRODUCTS INCLUDING WITHOUT LIMITATION IMPLIED WARRANTIES OF MERCHANTABILITY, FITNESS FOR A PARTICULAR PURPOSE (AND THEIR EQUIVALENTS UNDER THE LAWS OF ANY JURISDICTION), OR INFRINGEMENT OF ANY PATENT, COPYRIGHT OR OTHER INTELLECTUAL PROPERTY RIGHT.

UNLESS EXPRESSLY APPROVED IN WRITING BY AN AUTHORIZED ST REPRESENTATIVE, ST PRODUCTS ARE NOT RECOMMENDED, AUTHORIZED OR WARRANTED FOR USE IN MILITARY, AIR CRAFT, SPACE, LIFE SAVING, OR LIFE SUSTAINING APPLICATIONS, NOR IN PRODUCTS OR SYSTEMS WHERE FAILURE OR MALFUNCTION MAY RESULT IN PERSONAL INJURY, DEATH, OR SEVERE PROPERTY OR ENVIRONMENTAL DAMAGE. ST PRODUCTS WHICH ARE NOT SPECIFIED AS "AUTOMOTIVE GRADE" MAY ONLY BE USED IN AUTOMOTIVE APPLICATIONS AT USER'S OWN RISK.

Resale of ST products with provisions different from the statements and/or technical features set forth in this document shall immediately void any warranty granted by ST for the ST product or service described herein and shall not create or extend in any manner whatsoever, any liability of ST.

ST and the ST logo are trademarks or registered trademarks of ST in various countries.

Information in this document supersedes and replaces all information previously supplied.

The ST logo is a registered trademark of STMicroelectronics. All other names are the property of their respective owners.

© 2011 STMicroelectronics - All rights reserved

STMicroelectronics group of companies

Australia - Belgium - Brazil - Canada - China - Czech Republic - Finland - France - Germany - Hong Kong - India - Israel - Italy - Japan - Malaysia - Malta - Morocco - Philippines - Singapore - Spain - Sweden - Switzerland - United Kingdom - United States of America

www.st.com