

# Spezifikation für Freigabe / specification for release

Kunde / customer :  
 Artikelnummer / part number : **7447715330**  
 Bezeichnung : **SPEICHERDROSSEL WE-PD**  
 description : **POWER-CHOKE WE-PD**



DATUM / DATE : 2008-11-01

## A Mechanische Abmessungen / dimensions :

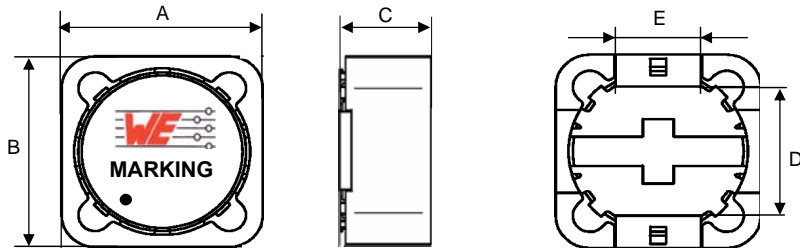

● Start of winding

Marking = Inductance code

	Typ LS	
A	<b>12,0 ± 0,3</b>	mm
B	<b>12,0 ± 0,3</b>	mm
C	<b>4,5 max.</b>	mm
D	<b>8,0 ± 0,3</b>	mm
E	<b>5 ± 0,2</b>	mm

## B Elektrische Eigenschaften / electrical properties :

Eigenschaften / properties	Testbedingungen / test conditions		Wert / value	Einheit / unit	tol.
Induktivität / inductance	<b>1 kHz / 5mA</b>	L	<b>33,00</b>	μH	<b>±20%</b>
DC-Widerstand / DC-resistance	<b>@ 20°C</b>	R <sub>DC typ</sub>	<b>75,0</b>	mΩ	<b>typ.</b>
DC-Widerstand / DC-resistance	<b>@ 20°C</b>	R <sub>DC max</sub>	<b>85,0</b>	mΩ	<b>max.</b>
Nennstrom / rated current	<b>ΔT=40 K</b>	I <sub>DC</sub>	<b>2,30</b>	A	<b>max.</b>
Sättigungsstrom / saturation current	<b> ΔL/L &lt;10%</b>	I <sub>sat</sub>	<b>2,50</b>	A	<b>typ.</b>
Eigenres.-Frequenz , self-res.-frequency	<b>@ 20°C</b>	SRF	<b>13,0</b>	MHz	<b>typ.</b>

## C Lötpad / soldering spec. :

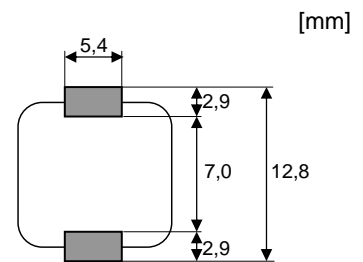

## D Prüfgeräte / test equipment :

**Wayne Kerr 3260B** für/for L und/and I<sub>SAT</sub>  
**HP 34401 A** für/for I<sub>DC</sub>  
**GMC 27i** für/for R<sub>DC</sub>

## E Testbedingungen / test conditions :

Luftfeuchtigkeit / humidity: 33%  
 Umgebungstemperatur / temperature: +20°C

## F Werkstoffe & Zulassungen / material & approvals :

Basismaterial / base material: Ferrit/ferrite  
 Endoberfläche / finishing electrode: 100% Sn  
 Draht / wire: SFT-EI / AIWJ  
 UL-File Number: E174837

## G Eigenschaften / general specifications :

Betriebstemp. / operating temperature: -40°C - +125°C  
 Umgebungstemp. / ambient temperature: -40°C - +85°C  
 ( It is recommended that the temperature of the part does not exceed 125°C under worst case operating conditions. )  
 Lagertemperatur / storage temperature: -20°C - +60°C

Freigabe erteilt / general release:	<b>Kunde / customer</b>		
Datum / date	Unterschrift / signature		
	<b>Würth Elektronik</b>		
Geprüft / checked	Kontrolliert / approved	OO	Version 1
		Name	Änderung / modification
			Datum / date

### Würth Elektronik eiSos GmbH & Co.KG

D-74638 Waldenburg · Max-Eyth-Straße 1 - 3 · Germany · Telefon (+49) (0) 7942 - 945 - 0 · Telefax (+49) (0) 7942 - 945 - 400  
<http://www.we-online.com>

# Spezifikation für Freigabe / specification for release

Kunde / customer : \_\_\_\_\_  
 Artikelnummer / part number : **7447715330**  
 Bezeichnung : **SPEICHERDROSSEL WE-PD**  
 description : **POWER-CHOKE WE-PD**



DATUM / DATE : 2008-11-01

## H Induktivitätskurve / Inductance curve :

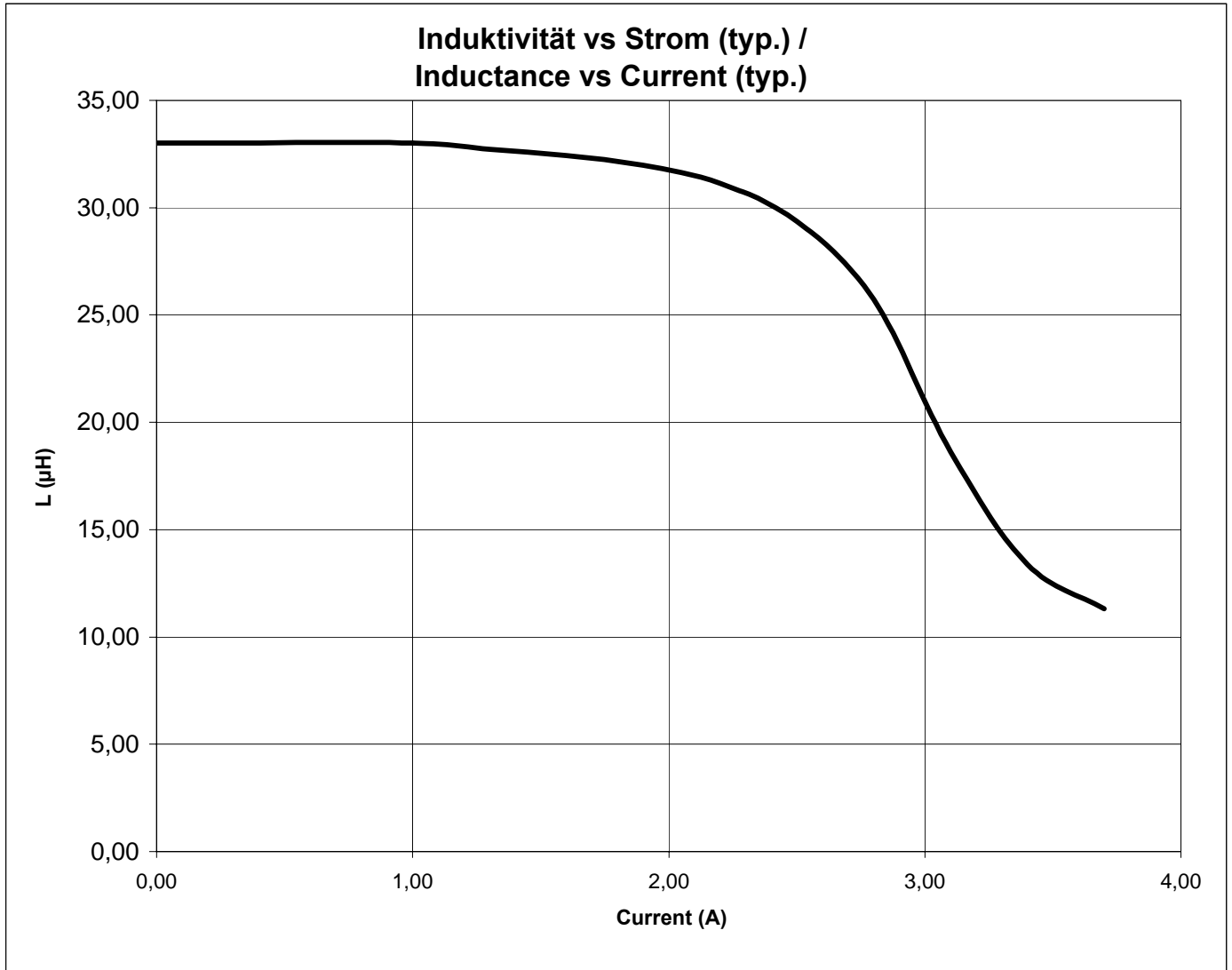

Freigabe erteilt / general release:	<b>Kunde / customer</b>			
Datum / date	Unterschrift / signature			
	<b>Würth Elektronik</b>			
Geprüft / checked	Kontrolliert / approved	OO	Version 1	08-11-01
		Name	Änderung / modification	Datum / date

**Würth Elektronik eiSos GmbH & Co.KG**

D-74638 Waldenburg · Max-Eyth-Straße 1 - 3 · Germany · Telefon (+49) (0) 7942 - 945 - 0 · Telefax (+49) (0) 7942 - 945 - 400  
<http://www.we-online.com>

# Spezifikation für Freigabe / specification for release

Kunde / customer : \_\_\_\_\_  
 Artikelnummer / part number : **7447715330**  
 Bezeichnung : **SPEICHERDROSSEL WE-PD**  
 description : **POWER-CHOKE WE-PD**



DATUM / DATE : 2008-11-01

## I Induktivitäts-Temperatur-Kurve / Inductance Temperature curve :

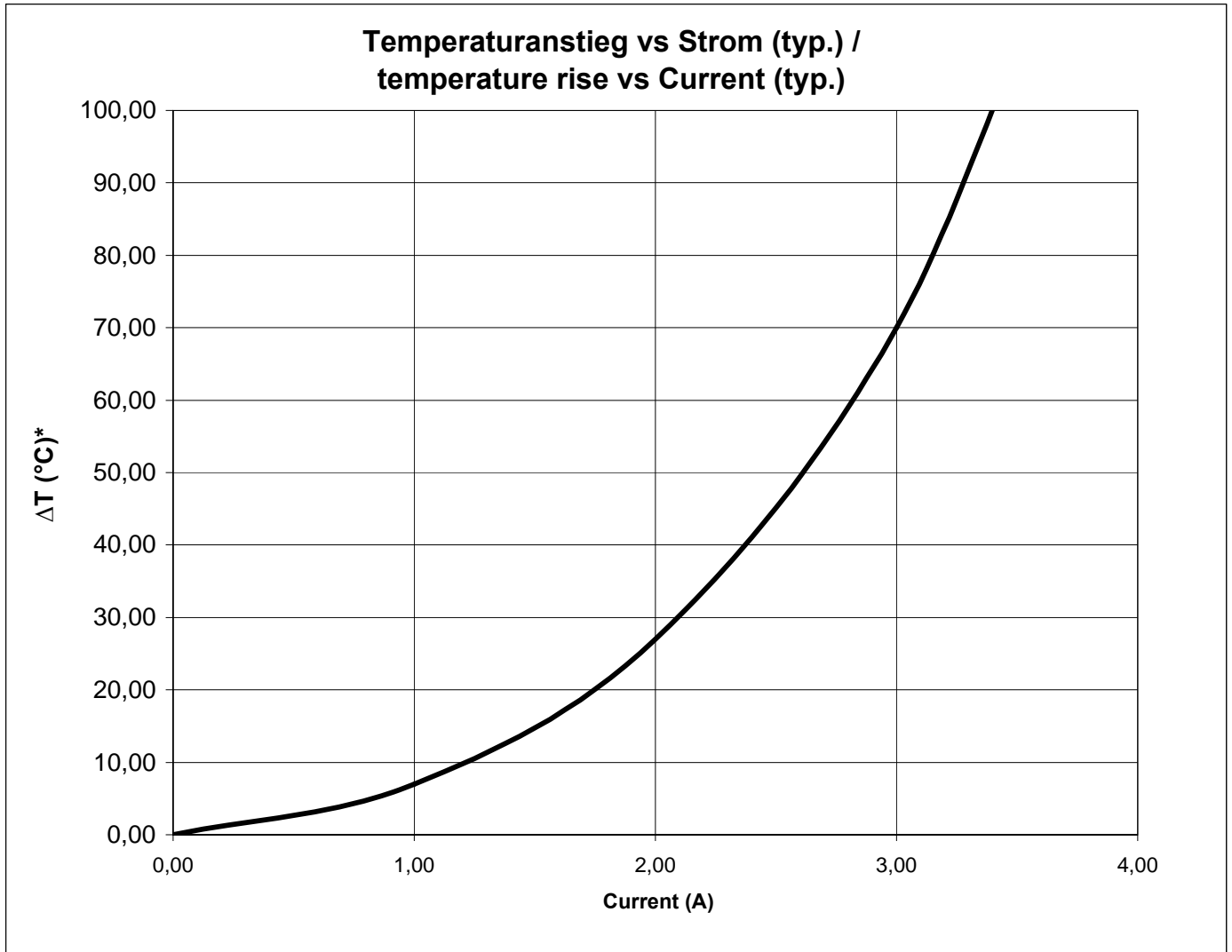

\*Temperatur gemessen an Bauteiloberfläche / temperature measured at surface of component

Freigabe erteilt / general release:	<b>Kunde / customer</b>			
.....	.....			
Datum / date	Unterschrift / signature			
	<b>Würth Elektronik</b>			
.....	.....			
Geprüft / checked	Kontrolliert / approved	OO	Version 1	08-11-01
		Name	Änderung / modification	Datum / date

**Würth Elektronik eiSos GmbH & Co.KG**

D-74638 Waldenburg · Max-Eyth-Straße 1 - 3 · Germany · Telefon (+49) (0) 7942 - 945 - 0 · Telefax (+49) (0) 7942 - 945 - 400  
<http://www.we-online.com>

# Spezifikation für Freigabe / specification for release

Kunde / customer : \_\_\_\_\_  
 Artikelnummer / part number : **7447715330**  
 Bezeichnung : **SPEICHERDROSSEL WE-PD**  
 description : **POWER-CHOKE WE-PD**



DATUM / DATE : 2008-11-01

## K Rollenspezifikation / tape and reel specification :

## Gurtspezifikation / Tape specification:

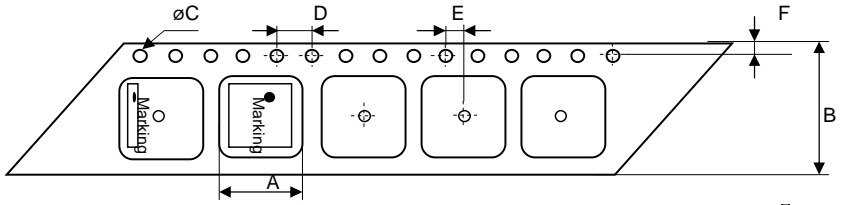

A	12,70 ± 0,1	mm
B	24,0 ± 0,2	mm
C	1,50 ± 0,1	mm
D	4,00 ± 0,1	mm
E	2,00 ± 0,1	mm
F	1,75 ± 0,1	mm
G	12,70 ± 0,1	mm
H	5,50 ± 0,1	mm

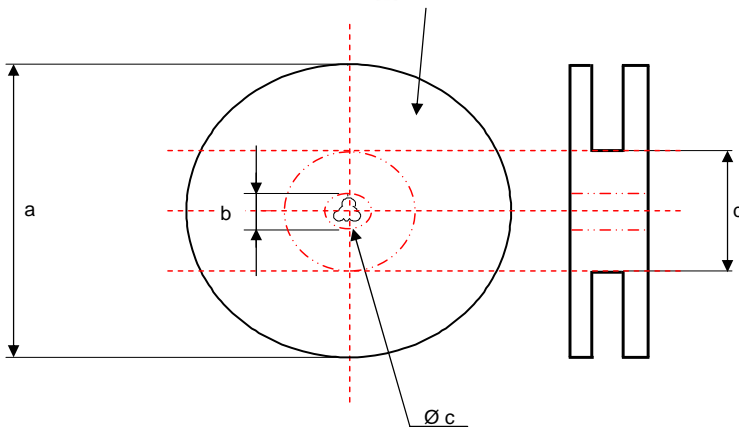
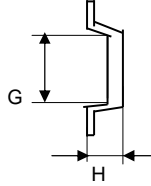

## Rollenspezifikation / Reel specification:

a	330,0 ± 2,0	mm
b	21,00 ± 0,8	mm
c	13,00 ± 0,5	mm
d	100,0 ± 1,0	mm

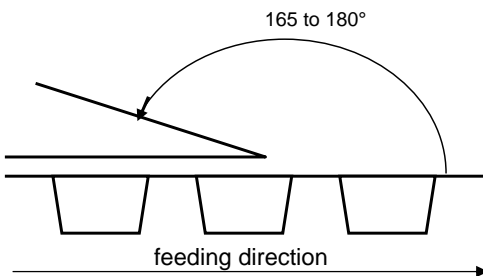

The force for tearing off cover tape is 1C to 130 grams in arrow direction

Freigabe erteilt / general release:	<b>Kunde / customer</b>			
.....	.....			
Datum / date	Unterschrift / signature			
	<b>Würth Elektronik</b>			
.....	.....	OO	Version 1	08-11-01
Geprüft / checked	Kontrolliert / approved	Name	Änderung / modification	Datum / date

This electronic component has been designed and developed for usage in general electronic equipment. Before incorporating this component into any equipment where higher safety and reliability is especially required or if there is the possibility of direct damage or injury to human body, for example in the range of aerospace, aviation, nuclear control, submarine, transportation, (automotive control, train control, ship control), transportation signal, disaster prevention, medical, public information network etc, Würth Elektronik eiSos GmbH must be informed before the design-in stage. In addition, sufficient reliability evaluation checks for safety must be performed on every electronic component which is used in electrical circuits that require high safety and reliability functions or performance.

**Würth Elektronik eiSos GmbH & Co.KG**

D-74638 Waldenburg · Max-Eyth-Straße 1 - 3 · Germany · Telefon (+49) (0) 7942 - 945 - 0 · Telefax (+49) (0) 7942 - 945 - 400  
<http://www.we-online.com>