

# NSM6056MT1G

## NPN Transistor with Zener Diode

### Features

- These Devices are Pb-Free, Halogen Free/BFR Free and are RoHS Compliant

### Typical Applications

- Driving Circuit
- Switching Applications

### MAXIMUM RATINGS – NPN TRANSISTOR

Rating	Symbol	Value	Unit
Collector – Emitter Voltage	$V_{CEO}$	40	V
Collector – Base Voltage	$V_{CBO}$	60	V
Emitter – Base Voltage	$V_{EBO}$	6.0	V
Collector Current – Continuous	$I_C$	600	mA
Collector Current – Peak	$I_{CM}$	900	mA

### MAXIMUM RATINGS – ZENER DIODE

Rating	Symbol	Value	Unit
Forward Voltage @ $I_F = 10$ mA	$V_F$	0.9	V

### THERMAL CHARACTERISTICS

Rating	Symbol	Max	Unit
Total Device Dissipation FR-5 Board, (Note 1) @ $T_A = 25^\circ\text{C}$	$P_D$	380	mW
Thermal Resistance from Junction-to-Ambient	$R_{\theta JA}$	328	$^\circ\text{C/W}$
Junction and Storage Temperature Range	$T_J, T_{stg}$	-55 to +150	$^\circ\text{C}$

Stresses exceeding Maximum Ratings may damage the device. Maximum Ratings are stress ratings only. Functional operation above the Recommended Operating Conditions is not implied. Extended exposure to stresses above the Recommended Operating Conditions may affect device reliability.

1. FR-4 Minimum Pad.



**ON Semiconductor®**

<http://onsemi.com>

## NPN Transistor with Zener Diode

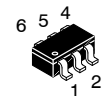
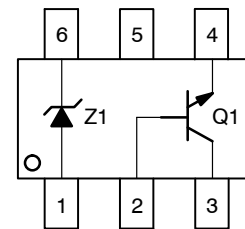

SC-74  
CASE 318F

### MARKING DIAGRAM

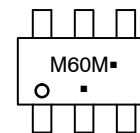

M60 = Device Code  
M = Date Code\*  
▪ = Pb-Free Package

(Note: Microdot may be in either location)  
\*Date Code orientation may vary depending upon manufacturing location.

### ORDERING INFORMATION

Device	Package	Shipping†
NSM6056MT1G	SC-74 (Pb-Free)	3000/Tape & Reel

†For information on tape and reel specifications, including part orientation and tape sizes, please refer to our Tape and Reel Packaging Specification Brochure, BRD8011/D.

# NSM6056MT1G

## NPN TRANSISTOR – ELECTRICAL CHARACTERISTICS (T<sub>A</sub> = 25°C unless otherwise noted)

Characteristic	Symbol	Min	Max	Unit
<b>OFF CHARACTERISTICS</b>				
Collector – Emitter Breakdown Voltage (Note 3) (I <sub>C</sub> = 1.0 mA <sub>dc</sub> , I <sub>B</sub> = 0)	V <sub>(BR)CEO</sub>	40	–	Vdc
Collector – Base Breakdown Voltage (I <sub>C</sub> = 0.1 mA <sub>dc</sub> , I <sub>E</sub> = 0)	V <sub>(BR)CBO</sub>	60	–	Vdc
Emitter – Base Breakdown Voltage (I <sub>E</sub> = 0.1 mA <sub>dc</sub> , I <sub>C</sub> = 0)	V <sub>(BR)EBO</sub>	6.0	–	Vdc
Base Cutoff Current (V <sub>CE</sub> = 35 Vdc, V <sub>EB</sub> = 0.4 Vdc)	I <sub>BEV</sub>	–	0.1	μA <sub>dc</sub>
Collector Cutoff Current (V <sub>CE</sub> = 35 Vdc, V <sub>EB</sub> = 0.4 Vdc)	I <sub>CEX</sub>	–	0.1	μA <sub>dc</sub>

### ON CHARACTERISTICS (Note 3)

DC Current Gain (I <sub>C</sub> = 0.1 mA <sub>dc</sub> , V <sub>CE</sub> = 1.0 Vdc) (I <sub>C</sub> = 1.0 mA <sub>dc</sub> , V <sub>CE</sub> = 1.0 Vdc) (I <sub>C</sub> = 10 mA <sub>dc</sub> , V <sub>CE</sub> = 1.0 Vdc) (I <sub>C</sub> = 150 mA <sub>dc</sub> , V <sub>CE</sub> = 1.0 Vdc) (I <sub>C</sub> = 500 mA <sub>dc</sub> , V <sub>CE</sub> = 2.0 Vdc)	h <sub>FE</sub>	20 40 80 100 40	– – – 300 –	–
Collector – Emitter Saturation Voltage (I <sub>C</sub> = 150 mA <sub>dc</sub> , I <sub>B</sub> = 15 mA <sub>dc</sub> ) (I <sub>C</sub> = 500 mA <sub>dc</sub> , I <sub>B</sub> = 50 mA <sub>dc</sub> )	V <sub>CE(sat)</sub>	– –	0.4 0.75	Vdc
Base – Emitter Saturation Voltage (I <sub>C</sub> = 150 mA <sub>dc</sub> , I <sub>B</sub> = 15 mA <sub>dc</sub> ) (I <sub>C</sub> = 500 mA <sub>dc</sub> , I <sub>B</sub> = 50 mA <sub>dc</sub> )	V <sub>BE(sat)</sub>	0.75 –	0.95 1.2	Vdc

### SMALL-SIGNAL CHARACTERISTICS

Current – Gain – Bandwidth Product (I <sub>C</sub> = 20 mA <sub>dc</sub> , V <sub>CE</sub> = 10 Vdc, f = 100 MHz)	f <sub>T</sub>	250	–	MHz
Collector – Base Capacitance (V <sub>CB</sub> = 5.0 Vdc, I <sub>E</sub> = 0, f = 1.0 MHz)	C <sub>cb</sub>	–	6.5	pF
Emitter – Base Capacitance (V <sub>EB</sub> = 0.5 Vdc, I <sub>C</sub> = 0, f = 1.0 MHz)	C <sub>eb</sub>	–	30	pF
Input Impedance (I <sub>C</sub> = 1.0 mA <sub>dc</sub> , V <sub>CE</sub> = 10 Vdc, f = 1.0 kHz)	h <sub>ie</sub>	1.0	15	kΩ
Voltage Feedback Ratio (I <sub>C</sub> = 1.0 mA <sub>dc</sub> , V <sub>CE</sub> = 10 Vdc, f = 1.0 kHz)	h <sub>re</sub>	0.1	8.0	X 10 <sup>-4</sup>
Small – Signal Current Gain (I <sub>C</sub> = 1.0 mA <sub>dc</sub> , V <sub>CE</sub> = 10 Vdc, f = 1.0 kHz)	h <sub>fe</sub>	40	500	–
Output Admittance (I <sub>C</sub> = 1.0 mA <sub>dc</sub> , V <sub>CE</sub> = 10 Vdc, f = 1.0 kHz)	h <sub>oe</sub>	1.0	30	μmhos

### SWITCHING CHARACTERISTICS

Delay Time	(V <sub>CC</sub> = 30 Vdc, V <sub>EB</sub> = 2.0 Vdc, I <sub>C</sub> = 150 mA <sub>dc</sub> , I <sub>B1</sub> = 15 mA <sub>dc</sub> )	t <sub>d</sub>	–	15	ns
Rise Time		t <sub>r</sub>	–	20	
Storage Time	(V <sub>CC</sub> = 30 Vdc, I <sub>C</sub> = 150 mA <sub>dc</sub> , I <sub>B1</sub> = I <sub>B2</sub> = 15 mA <sub>dc</sub> )	t <sub>s</sub>	–	225	ns
Fall Time		t <sub>f</sub>	–	30	

2. Pulse Test: Pulse Width ≤ 300 μs, Duty Cycle ≤ 2.0%.

### ZENER DIODE – ELECTRICAL CHARACTERISTICS (V<sub>F</sub> = 0.9 Max @ I<sub>F</sub> = 10 mA for all types)

Device	Test Current I <sub>zt</sub> mA	Zener Voltage V <sub>Z</sub>		Z <sub>ZK</sub> I <sub>Z</sub> = 0.5 mA Ω Max	Z <sub>ZT</sub> I <sub>Z</sub> = I <sub>ZT</sub> @ 10% Mod Ω Max	Max IR @ V <sub>R</sub>		dV <sub>Z</sub> /dt (mV/k) @ I <sub>ZT1</sub> = 5 mA		C pF Max @ V <sub>R</sub> = 0 f = 1 MHz
		Min	Max			μA	V	Min	Max	
NSM6056MT1G	5.0	5.49	5.73	200	40	1.0	2.0	-2.0	2.5	200

# NSM6056MT1G

## TYPICAL ELECTRICAL CHARACTERISTICS – NPN TRANSISTOR

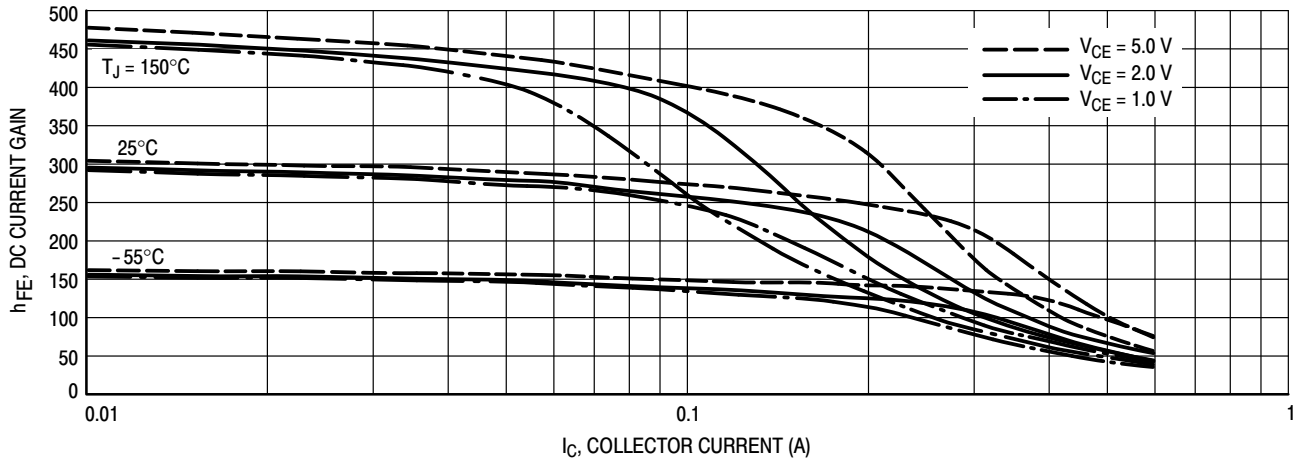

Figure 1. DC Current Gain

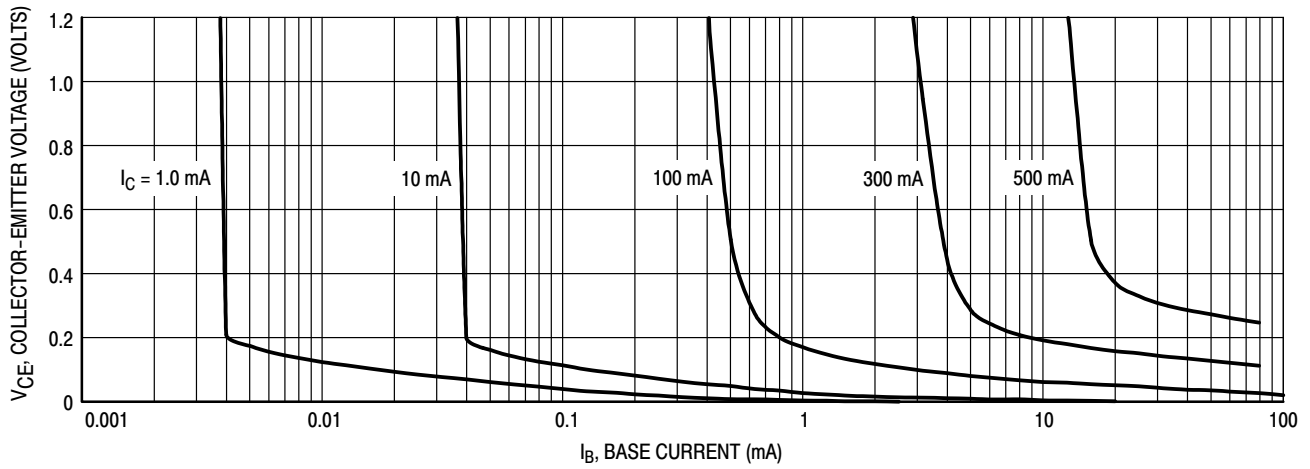

Figure 2. Collector Saturation Region

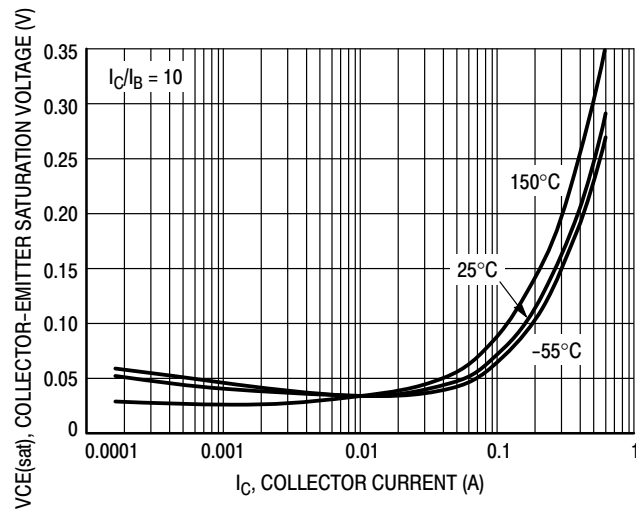

Figure 3. Collector-Emitter Saturation Voltage vs. Collector Current

# NSM6056MT1G

## TYPICAL ELECTRICAL CHARACTERISTICS - NPN TRANSISTOR

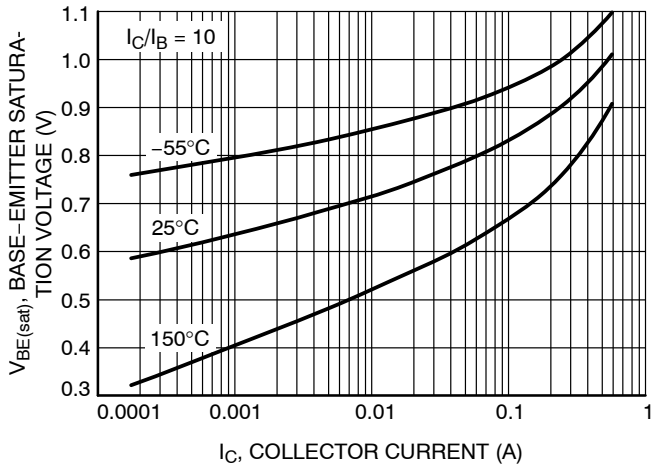

Figure 4. Base-Emitter Saturation Voltage vs. Collector Current

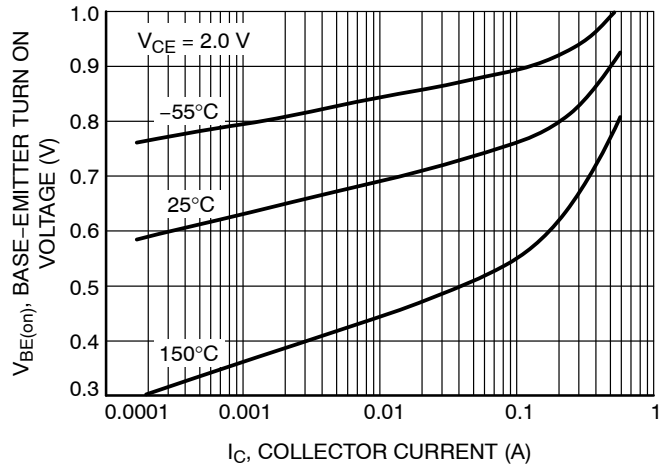

Figure 5. Base-Emitter Turn On Voltage vs. Collector Current

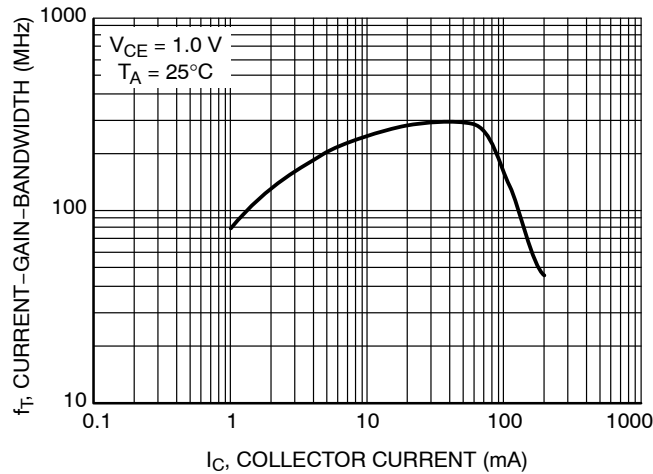

Figure 6. Current-Gain-Bandwidth Product

## TYPICAL ELECTRICAL CHARACTERISTICS - ZENER DIODE

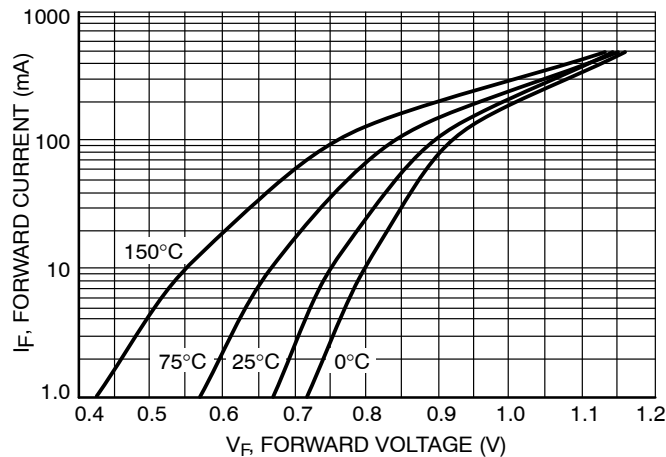
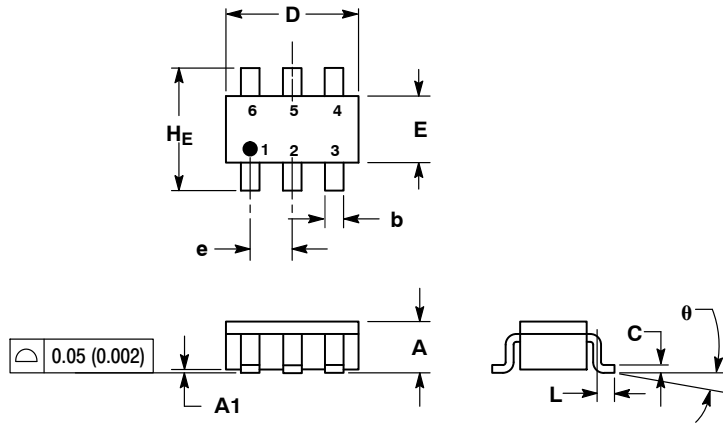

Figure 7. Typical Forward Voltage

# NSM6056MT1G

## PACKAGE DIMENSIONS

SC-74  
CASE 318F-05  
ISSUE M



- NOTES:
1. DIMENSIONING AND TOLERANCING PER ANSI Y14.5M, 1982.
  2. CONTROLLING DIMENSION: INCH.
  3. MAXIMUM LEAD THICKNESS INCLUDES LEAD FINISH THICKNESS. MINIMUM LEAD THICKNESS IS THE MINIMUM THICKNESS OF BASE MATERIAL.
  4. 318F-01, -02, -03 OBSOLETE. NEW STANDARD 318F-04.

DIM	MILLIMETERS			INCHES		
	MIN	NOM	MAX	MIN	NOM	MAX
A	0.90	1.00	1.10	0.035	0.039	0.043
A1	0.01	0.06	0.10	0.001	0.002	0.004
b	0.25	0.37	0.50	0.010	0.015	0.020
c	0.10	0.18	0.26	0.004	0.007	0.010
D	2.90	3.00	3.10	0.114	0.118	0.122
E	1.30	1.50	1.70	0.051	0.059	0.067
e	0.85	0.95	1.05	0.034	0.037	0.041
L	0.20	0.40	0.60	0.008	0.016	0.024
HE	2.50	2.75	3.00	0.099	0.108	0.118
θ	0°	-	10°	0°	-	10°

### SOLDERING FOOTPRINT\*

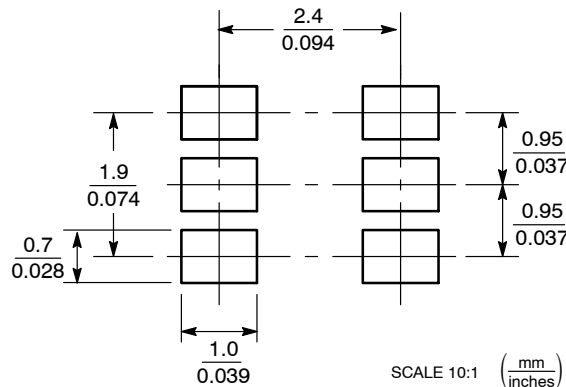

\*For additional information on our Pb-Free strategy and soldering details, please download the ON Semiconductor Soldering and Mounting Techniques Reference Manual, SOLDERRM/D.

ON Semiconductor and are registered trademarks of Semiconductor Components Industries, LLC (SCILLC). SCILLC reserves the right to make changes without further notice to any products herein. SCILLC makes no warranty, representation or guarantee regarding the suitability of its products for any particular purpose, nor does SCILLC assume any liability arising out of the application or use of any product or circuit, and specifically disclaims any and all liability, including without limitation special, consequential or incidental damages. "Typical" parameters which may be provided in SCILLC data sheets and/or specifications can and do vary in different applications and actual performance may vary over time. All operating parameters, including "Typicals" must be validated for each customer application by customer's technical experts. SCILLC does not convey any license under its patent rights nor the rights of others. SCILLC products are not designed, intended, or authorized for use as components in systems intended for surgical implant into the body, or other applications intended to support or sustain life, or for any other application in which the failure of the SCILLC product could create a situation where personal injury or death may occur. Should Buyer purchase or use SCILLC products for any such unintended or unauthorized application, Buyer shall indemnify and hold SCILLC and its officers, employees, subsidiaries, affiliates, and distributors harmless against all claims, costs, damages, and expenses, and reasonable attorney fees arising out of, directly or indirectly, any claim of personal injury or death associated with such unintended or unauthorized use, even if such claim alleges that SCILLC was negligent regarding the design or manufacture of the part. SCILLC is an Equal Opportunity/Affirmative Action Employer. This literature is subject to all applicable copyright laws and is not for resale in any manner.

### PUBLICATION ORDERING INFORMATION

**LITERATURE FULFILLMENT:**  
Literature Distribution Center for ON Semiconductor  
P.O. Box 5163, Denver, Colorado 80217 USA  
**Phone:** 303-675-2175 or 800-344-3860 Toll Free USA/Canada  
**Fax:** 303-675-2176 or 800-344-3867 Toll Free USA/Canada  
**Email:** orderlit@onsemi.com

**N. American Technical Support:** 800-282-9855 Toll Free USA/Canada  
**Europe, Middle East and Africa Technical Support:**  
Phone: 421 33 790 2910  
**Japan Customer Focus Center**  
Phone: 81-3-5773-3850

**ON Semiconductor Website:** [www.onsemi.com](http://www.onsemi.com)  
**Order Literature:** <http://www.onsemi.com/orderlit>  
For additional information, please contact your local Sales Representative