

APB3025SRQGCPRV

SUPER BRIGHT RED/GREEN

### Features

- 3.0mmx2.5mm SMT LED, 1.1mm THICKNESS.
- BI-COLOR, LOW POWER CONSUMPTION.
- WIDE VIEWING ANGLE.
- IDEAL FOR BACKLIGHT AND INDICATOR.
- VARIOUS COLORS AND LENS TYPES AVAILABLE.
- PACKAGE : 2000PCS / REEL.

### Description

The Super Bright Red source color devices are made with Gallium Aluminum Arsenide Red Light Emitting Diode.

The Green source color devices are made with Gallium Phosphide Green Light Emitting Diode.

### Package Dimensions

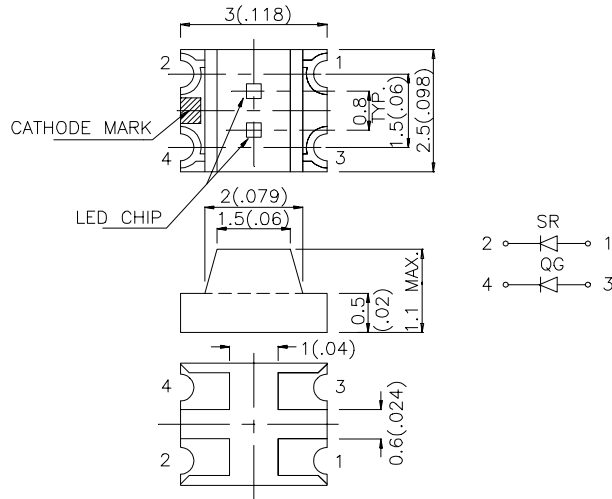

#### Notes:

1. All dimensions are in millimeters (inches).
2. Tolerance is  $\pm 0.2(0.0079)$ " unless otherwise noted.
3. Lead spacing is measured where the lead emerge package.
4. Specifications are subject to change without notice.

## Selection Guide

Part No.	Dice	Lens Type	Iv (mcd) @ 20 mA		Viewing Angle
			Min.	Typ.	2θ1/2
APB3025SRQGCPRV	SUPER BRIGHT RED (GaAlAs)	WATER CLEAR	20	80	120°
	GREEN (GaP)		3	12	

Note:

1. θ1/2 is the angle from optical centerline where the luminous intensity is 1/2 the optical centerline value.

## Electrical / Optical Characteristics at T<sub>A</sub>=25°C

Symbol	Parameter	Device	Typ.	Max.	Units	Test Conditions
λ <sub>peak</sub>	Peak Wavelength	Super Bright Red Green	660 560		nm	IF=20mA
λ <sub>D</sub>	Dominate Wavelength	Super Bright Red Green	640 565		nm	IF=20mA
Δλ <sub>1/2</sub>	Spectral Line Halfwidth	Super Bright Red Green	20 30		nm	IF=20mA
C	Capacitance	Super Bright Red Green	45 45		pF	VF=0V;f=1MHz
V <sub>F</sub>	Forward Voltage	Super Bright Red Green	1.85 2.15	2.5 2.5	V	IF=20mA
I <sub>R</sub>	Reverse Current	All		10	uA	VR = 5V

## Absolute Maximum Ratings at T<sub>A</sub>=25°C

Parameter	Super Bright Red	Green	Units
Power dissipation	100	105	mW
DC Forward Current	30	25	mA
Peak Forward Current [1]	155	130	mA
Reverse Voltage	5	5	V
Operating/Storage Temperature	-40°C To +85°C		

Note:

1. 1/10 Duty Cycle, 0.1ms Pulse Width.

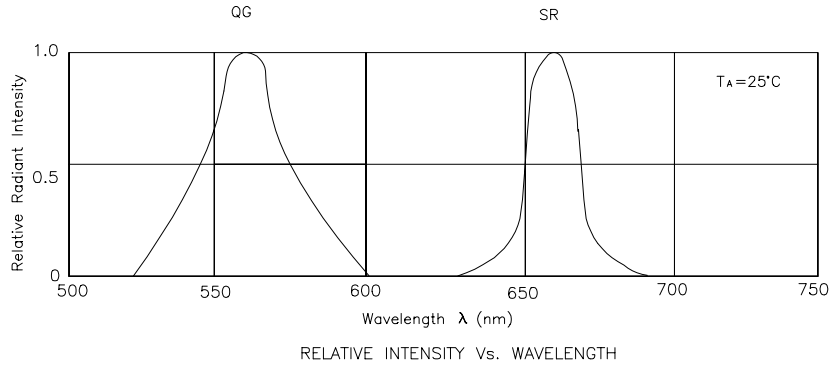

## Super Bright Red / Green APB3025SRQGCPRV

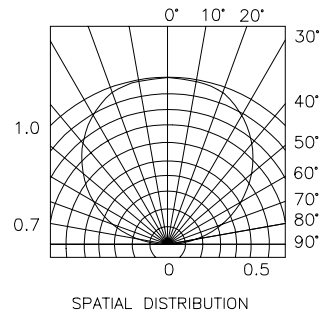
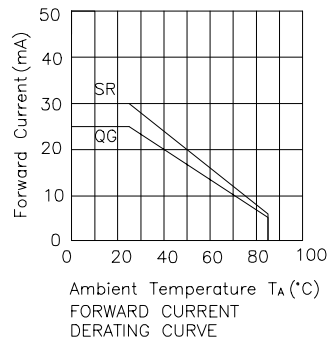
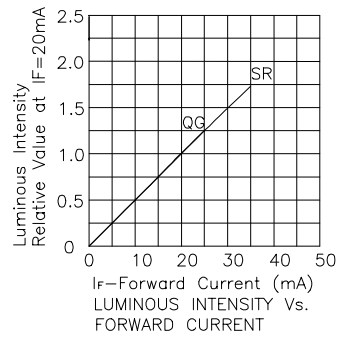
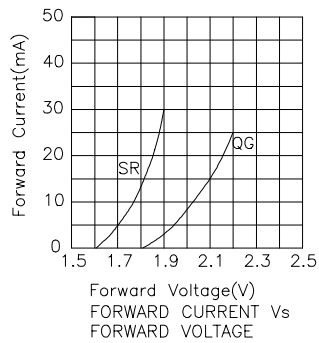

## APB3025SRQG CPRV SMT Reflow Soldering Instruction

Number of reflow process shall be less than 2 times and cooling process to normal temperature is required between first and second soldering process.

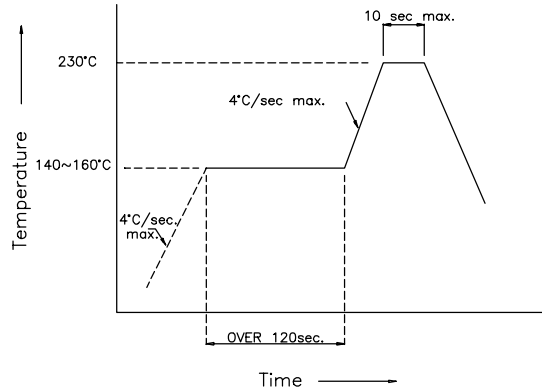

## Recommended Soldering Pattern (Units : mm)

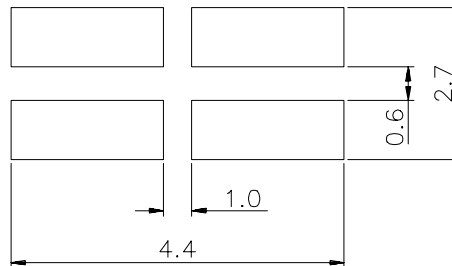

## Tape Specifications (Units : mm)

