



# UP1855A

## PNP SILICON TRANSISTOR

### HIGH CURRENT TRANSISTOR

■ FEATURES

- \* High current switching
- \* Low  $V_{CE(SAT)}$
- \* High  $h_{FE}$

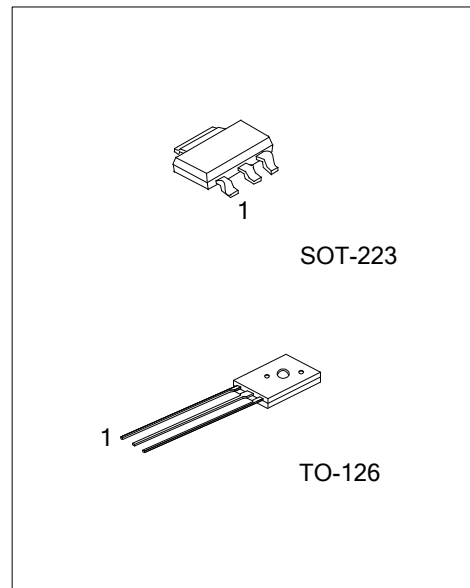

■ ORDERING INFORMATION

Ordering Number		Package	Pin Assignment			Packing
Lead Free	Halogen Free		1	2	3	
-	UP1855AG-x-AA3-R	SOT-223	B	C	E	Tape Reel
UP1855AL-x-T60-K	UP1855AG-x-T60-K	TO-126	E	C	B	Bulk

Note: Pin Assignment: E: Emitter B: Base C: Case

<p>UP1855AG-x-AA3-R</p> <p>(1) Packing Type (2) Package Type (3) Rank (4) Green Package</p>	<p>(1) R: Tape Reel, B: Bulk (2) AA3: SOT-223, T60: TO-126 (3) x: refer to Classification of <math>h_{FE3}</math> (4) G: Halogen Free and Lead Free, L: Lead Free</p>
---	---

■ MARKING

SOT-223	TO-126
<p>UP1855AG □□□□ → Data Code</p>	<p>UTC □□□□ → Data Code UP1855A □□□□ → Data Code L: Lead Free G: Halogen Free</p>

■ ABSOLUTE MAXIMUM RATINGS ( $T_A=25^\circ\text{C}$ , unless otherwise specified)

PARAMETER		SYMBOL	RATINGS	UNIT
Collector -Base Voltage		$V_{CB0}$	-180	V
Collector -Emitter Voltage		$V_{CE0}$	-170	V
Emitter -Base Voltage		$V_{EBO}$	-6	V
Collector Current (Pulse)		$I_{CM}$	-10	A
Collector Current (DC)		$I_C$	-4	A
Power Dissipation	SOT-223	$P_D$	1	W
	TO-126		1	
Junction Temperature		$T_J$	+150	$^\circ\text{C}$
Storage Temperature		$T_{STG}$	-40 ~ +150	$^\circ\text{C}$

Note: Absolute maximum ratings are those values beyond which the device could be permanently damaged. Absolute maximum ratings are stress ratings only and functional device operation is not implied.

■ ELECTRICAL CHARACTERISTICS ( $T_A=25^\circ\text{C}$ , unless otherwise specified)

PARAMETER	SYMBOL	TEST CONDITIONS	MIN	TYP	MAX	UNIT
Collector-Base Breakdown Voltage	$BV_{CB0}$	$I_C = -100\mu\text{A}$	-180	-210		V
Collector-Emitter Breakdown Voltage	$BV_{CE0}$	$I_C = -10\text{mA}$	-170			V
Emitter-Base Breakdown Voltage	$BV_{EBO}$	$I_E = -100\mu\text{A}$	-6	-8		V
Collector Cut-off Current	$I_{CBO}$	$V_{CB}=-150\text{V}$			-50	nA
		$V_{CB}=-150\text{V}, T_A=100^\circ\text{C}$			-1	$\mu\text{A}$
Emitter Cut-off Current	$I_{EBO}$	$V_{EB}=-6\text{V}$			-10	nA
Collector-Emitter Saturation Voltage	$V_{CE(SAT)}$	$I_C=-100\text{mA}, I_B=-5\text{mA}$		-30	-60	mV
		$I_C=-500\text{mA}, I_B=-50\text{mA}$		-70	-120	mV
		$I_C=-1\text{A}, I_B=-100\text{mA}$		-110	-150	mV
		$I_C=-3\text{A}, I_B=-300\text{mA}$		-275	-550	mV
Base-Emitter Saturation Voltage	$V_{BE(SAT)}$	$I_C=-3\text{A}, I_B=-300\text{mA}$		-970	-1110	mV
Base-Emitter Turn-On Voltage	$V_{BE(ON)}$	$I_C=-3\text{A}, V_{CE}=-5\text{V}$		-830	-950	mV
DC Current Gain	$h_{FE1}$	$I_C=-10\text{mA}, V_{CE}=-5\text{V}$	100	200		
	$h_{FE2}$	$I_C=-1\text{A}, V_{CE}=-5\text{V}$	100		300	
	$h_{FE3}$	$I_C=-3\text{A}, V_{CE}=-5\text{V}$	28	140		
	$h_{FE4}$	$I_C=-10\text{A}, V_{CE}=-5\text{V}$		10		
Transition Frequency	$f_T$	$I_C=-100\text{mA}, V_{CE}=-10\text{V}, f=50\text{MHz}$		110		MHz
Output Capacitance	$C_{ob}$	$V_{CB}=-20\text{V}, f=1\text{MHz}$		40		pF
Switching Times	$t_{ON}$	$I_C=-1\text{A}, V_{CC}=-50\text{V}$		68		ns
	$t_{OFF}$	$I_{B1}=-100\text{mA}, I_{B2}=100\text{mA}$		1030		ns

Note: Pulse test:  $t_P \leq 300\mu\text{s}$ , Duty cycle  $\leq 2\%$

■ CLASSIFICATION OF  $h_{FE3}$

RANK	A	B
RANGE	28~75	75(MIN.)

## TYPICAL CHARACTERISTICS

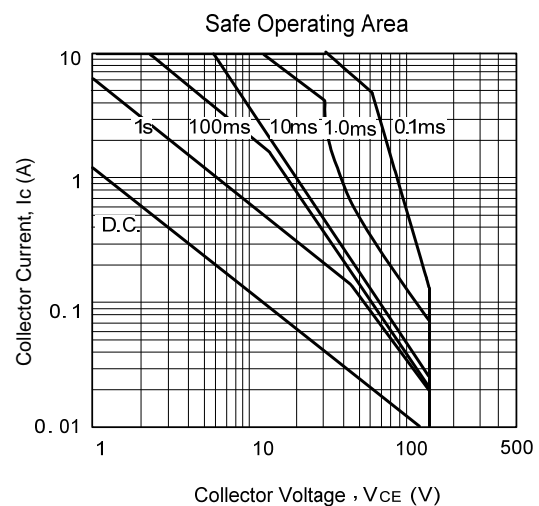
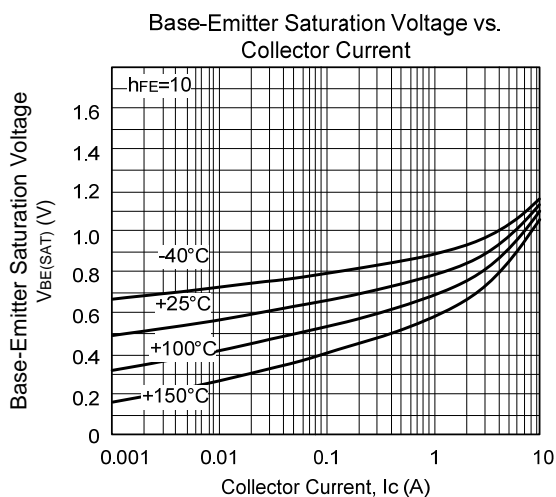
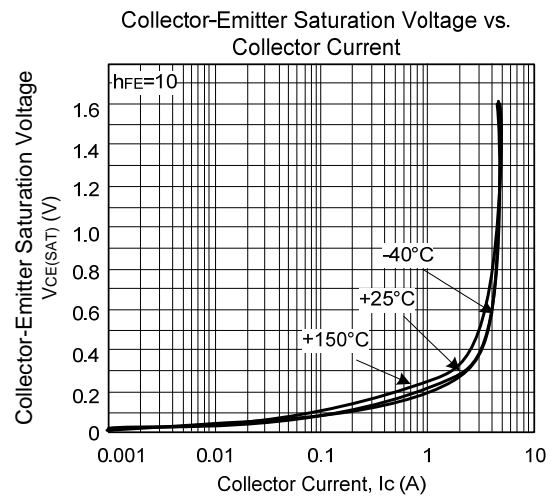
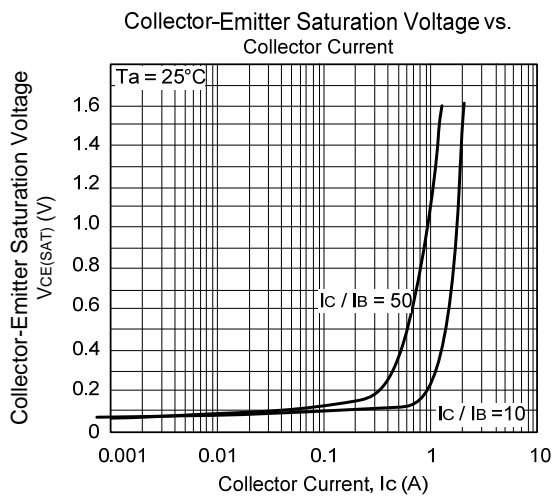
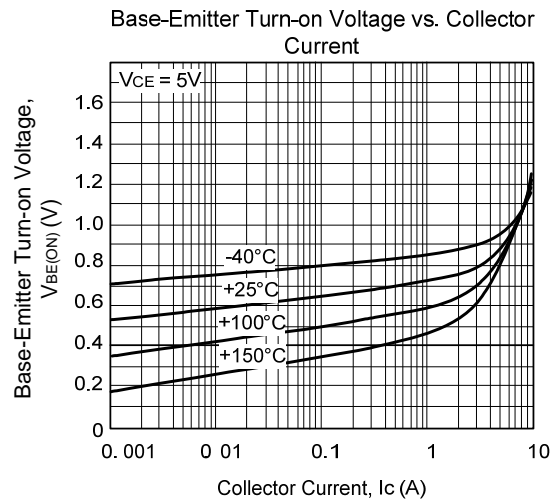
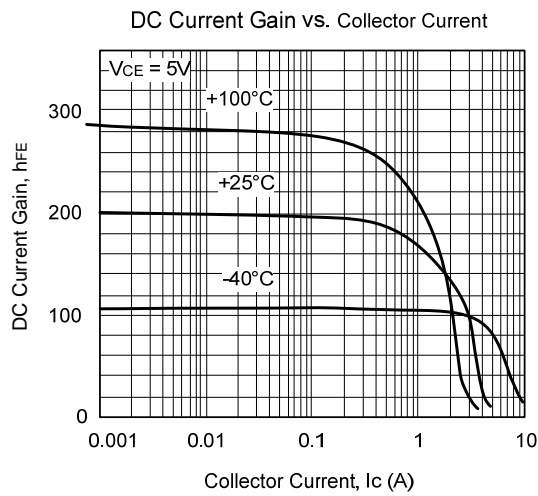

UTC assumes no responsibility for equipment failures that result from using products at values that exceed, even momentarily, rated values (such as maximum ratings, operating condition ranges, or other parameters) listed in products specifications of any and all UTC products described or contained herein. UTC products are not designed for use in life support appliances, devices or systems where malfunction of these products can be reasonably expected to result in personal injury. Reproduction in whole or in part is prohibited without the prior written consent of the copyright owner. The information presented in this document does not form part of any quotation or contract, is believed to be accurate and reliable and may be changed without notice.