

Rev	AWO #	Description	Date	Appr
-		RELEASED	7/7/04	

APPROVED: \_\_\_\_\_  
 DATE: \_\_\_\_\_ TITLE: \_\_\_\_\_

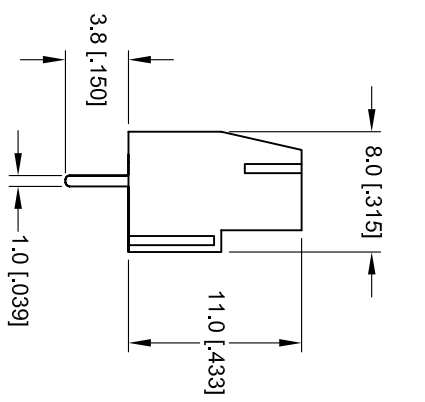
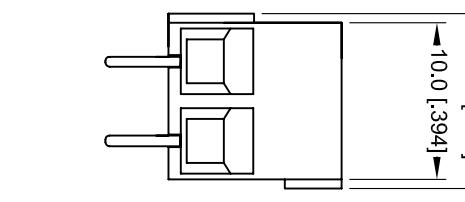
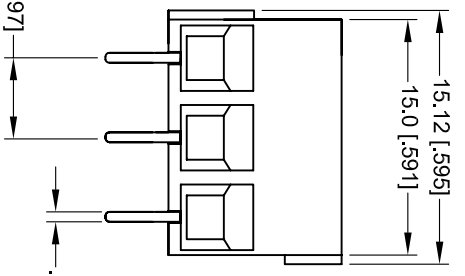
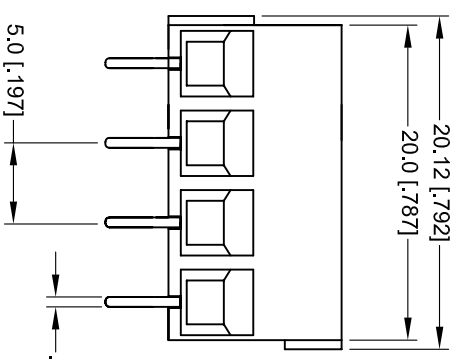
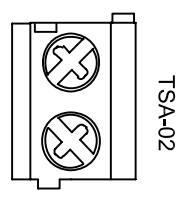
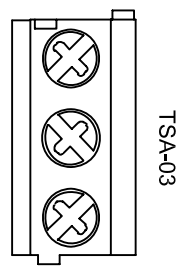
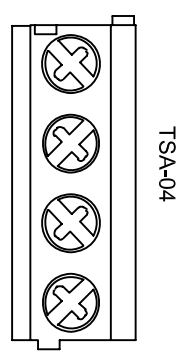

**SPECIFICATIONS:**

**Material:**

Insulator: Thermoplastic, Rated UL94V-0  
 Insulator color: Green  
 Terminals: Brass, Tin Plated  
 Screws: Steel, Zinc Plated.

**Electrical:**

Operation voltage: 300 VAC  
 Current rating: 10A  
 Insulation resistance: 500 Mohms @ 500 VDC.  
 Dielectric withstanding voltage: 2000 VAC / Min.

**Wire Range:**

16 To 22 Awg  
 Environmental:  
 Lead free, RoHS compliant.  
 Recommended soldering temp: 235°C for 5 sec.

UNLESS OTHERWISE SPECIFIED  
 ALL DIMENSIONS ARE MM [INCHES]  
 TOLERANCES: EXCEPT AS NOTED  
 INCHES HOLEES

.X	± .10	ØX	± .10
.XX	± .020	ØXXX	± .015
.XXX	± .015	ØXXX	± .010

APPROVALS DATE

**ADAM TECH**  
 909 Rahway Avenue, Union, NJ 07083  
 Phone: 908-687-5000 Fax: 908-687-5710

TITLE: **MICRO BLOCK, 2 AND 3 POSITION**

DRAWN	SS	7/7/04
CHECKED		
APPROVED		

SIZE	PART NO.	REV.
X	TSA-XX	
REF:	SCALE: NTS	SHEET 1 OF 1



6 5 4 3 2 1