

General Purpose Transistor

PNP Silicon

- We declare that the material of product compliance with RoHS requirements.
- S- Prefix for Automotive and Other Applications Requiring Unique Site and Control Change Requirements; AEC-Q101 Qualified and PPAP Capable.

LMBT2907LT1G
LMBT2907ALT1G
S-LMBT2907LT1G
S-LMBT2907ALT1G

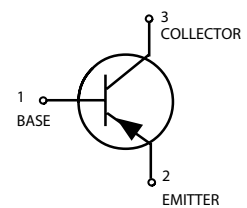
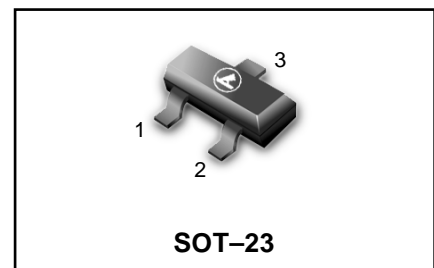

ORDERING INFORMATION

Device	Marking	Shipping
LMBT2907LT1G,S-LMBT2907LT1G	M2B	3000/Tape & Reel
LMBT2907LT3G,S-LMBT2907LT3G	M2B	10000/Tape & Reel
LMBT2907ALT1G,S-LMBT2907ALT1G	2F	3000/Tape & Reel
LMBT2907ALT3G,S-LMBT2907ALT3G	2F	10000/Tape & Reel

MAXIMUM RATINGS

Rating	Symbol	Value		Unit
		2907	2907A	
Collector–Emitter Voltage	V_{CEO}	-40	-60	Vdc
Collector–Base Voltage	V_{CBO}		-60	Vdc
Emitter–Base Voltage	V_{EBO}		-5.0	Vdc
Collector Current — Continuous	I_C		-600	mAdc

THERMAL CHARACTERISTICS

Characteristic	Symbol	Max	Unit
Total Device Dissipation FR-5 Board, (1) $T_A = 25^\circ\text{C}$	P_D	225	mW
Derate above 25°C		1.8	mW/ $^\circ\text{C}$
Thermal Resistance, Junction to Ambient	$R_{\theta JA}$	556	$^\circ\text{C}/\text{W}$
Total Device Dissipation Alumina Substrate, (2) $T_A = 25^\circ\text{C}$	P_D	300	mW
Derate above 25°C		2.4	mW/ $^\circ\text{C}$
Thermal Resistance, Junction to Ambient	$R_{\theta JA}$	417	$^\circ\text{C}/\text{W}$
Junction and Storage Temperature	T_J, T_{stg}	-55 to +150	$^\circ\text{C}$

Stresses exceeding Maximum Ratings may damage the device. Maximum Ratings are stress ratings only. Functional operation above the Recommended Operating Conditions is not implied. Extended exposure to stresses above the Recommended Operating Conditions may affect device reliability.

1. FR-5 = $1.0 \times 0.75 \times 0.062$ in.
2. Alumina = $0.4 \times 0.3 \times 0.024$ in. 99.5% alumina.

LMBT2907LT1G LMBT2907ALT1G
S-LMBT2907LT1G S-LMBT2907ALT1G

ELECTRICAL CHARACTERISTICS ($T_A = 25^\circ\text{C}$ unless otherwise noted.)

Characteristic	Symbol	Min	Max	Unit
----------------	--------	-----	-----	------

OFF CHARACTERISTICS

Collector–Emitter Breakdown Voltage(3) ($I_C = -10\text{ mAdc}$, $I_B = 0$)	LMBT2907 LMBT2907A	$V_{(BR)CEO}$	-40 -60	— —	Vdc
Collector–Emitter Breakdown Voltage($I_C = -10\ \mu\text{Adc}$, $I_E = 0$)		$V_{(BR)CBO}$	-60	—	Vdc
Emitter–Base Breakdown Voltage($I_E = -10\ \mu\text{Adc}$, $I_C = 0$)		$V_{(BR)EBO}$	-5.0	—	Vdc
Collector Cutoff Current($V_{CB} = -30\text{Vdc}$, $I_{BE(OFF)} = -0.5\text{Vdc}$)		I_{CEX}	—	-50	nAdc
Collector Cutoff Current ($V_{CB} = -50\text{Vdc}$, $I_E = 0$)	LMBT2907 LMBT2907A	I_{CBO}	— —	-0.020 -0.010	μAdc
($V_{CB} = -50\text{Vdc}$, $I_E = 0$, $T_A = 125^\circ\text{C}$)	LMBT2907 LMBT2907A		— —	-20 -10	
Base Current($V_{CE} = -30\text{Vdc}$, $V_{EB(OFF)} = -0.5\text{Vdc}$)		I_B	—	-50	nAdc

ON CHARACTERISTICS

DC Current Gain ($I_C = -0.1\text{mAdc}$, $V_{CE} = -10\text{ Vdc}$)	LMBT2907 LMBT2907A	h_{FE}	35 75	— —	
($I_C = -1.0\text{mAdc}$, $V_{CE} = -10\text{ Vdc}$)	LMBT2907 LMBT2907A		50 100	— —	
($I_C = -10\text{ mAdc}$, $V_{CE} = -10\text{Vdc}$)	LMBT2907 LMBT2907A		75 100	— —	
($I_C = -150\text{mAdc}$, $V_{CE} = -10\text{ Vdc}$)(3)	LMBT2907 LMBT2907A		— 100	— 300	
($I_C = -500\text{mAdc}$, $V_{CE} = -10\text{ Vdc}$)(3)	LMBT2907 LMBT2907A		30 50	— —	
Collector–Emitter Saturation Voltage(3) ($I_C = -150\text{mAdc}$, $I_B = -15\text{ mAdc}$) ($I_C = -500\text{ mAdc}$, $I_B = -50\text{ mAdc}$)		$V_{CE(sat)}$	— —	-0.4 -1.6	Vdc
Base–Emitter Saturation Voltage(3) ($I_C = -150\text{mAdc}$, $I_B = -15\text{ mAdc}$) ($I_C = -500\text{mAdc}$, $I_B = -50\text{ mAdc}$)		$V_{BE(sat)}$	— —	-1.3 -2.6	Vdc

3. Pulse Test: Pulse Width $\leq 300\ \mu\text{s}$, Duty Cycle $\leq 2.0\%$.

LMBT2907LT1G LMBT2907ALT1G
S-LMBT2907LT1G S-LMBT2907ALT1G

ELECTRICAL CHARACTERISTICS ($T_A = 25^\circ\text{C}$ unless otherwise noted) (Continued)

Characteristic	Symbol	Min	Max	Unit
----------------	--------	-----	-----	------

SMALL-SIGNAL CHARACTERISTICS

Current-Gain — Bandwidth Product(3),(4) ($I_C = -50\text{mA dc}$, $V_{CE} = -20\text{V dc}$, $f = 100\text{MHz}$)	f_T	200	—	MHz
Output Capacitance ($V_{CB} = -10\text{V dc}$, $I_E = 0$, $f = 1.0\text{MHz}$)	C_{obo}	—	8.0	pF
Input Capacitance ($V_{EB} = -2.0\text{V dc}$, $I_C = 0$, $f = 1.0\text{MHz}$)	C_{ibo}	—	30	pF

SWITCHING CHARACTERISTICS

Turn-On Time	($V_{CC} = -30\text{V dc}$,	t_{on}	—	45	
Delay Time	$I_C = -150\text{mA dc}$, $I_{B1} = -15\text{mA dc}$)	t_d	—	10	ns
Rise Time		t_r	—	40	
Fall Time	($V_{CC} = -6.0\text{V dc}$,	t_f	—	60	
Storage Time	$I_C = -150\text{mA dc}$, $I_{B1} = I_{B2} = 15\text{mA dc}$)	t_s	—	225	ns
Turn-Off Time		t_{off}	—	280	

4. f_T is defined as the frequency at which $|h_{fe}|$ extrapolates to unity.

TYPICAL CHARACTERISTICS

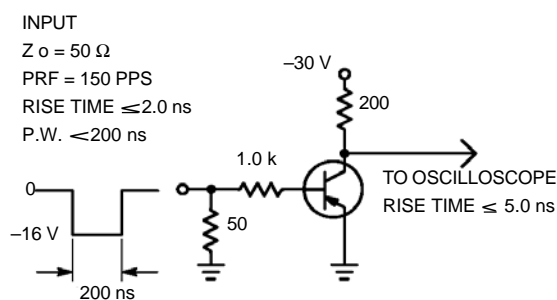

Figure 1. Delay and Rise Time Test Circuit

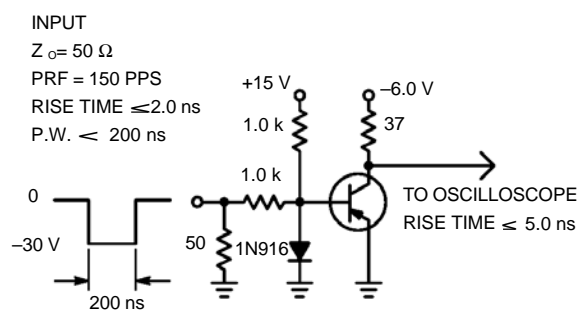

Figure 2. Storage and Fall Time Test Circuit

TYPICAL CHARACTERISTICS

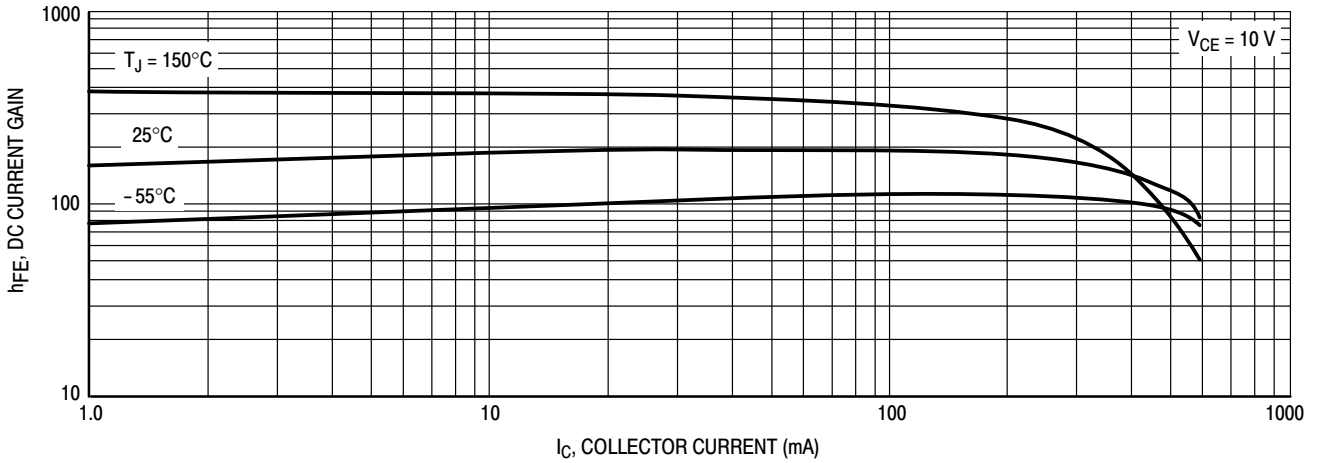

Figure 3. DC Current Gain

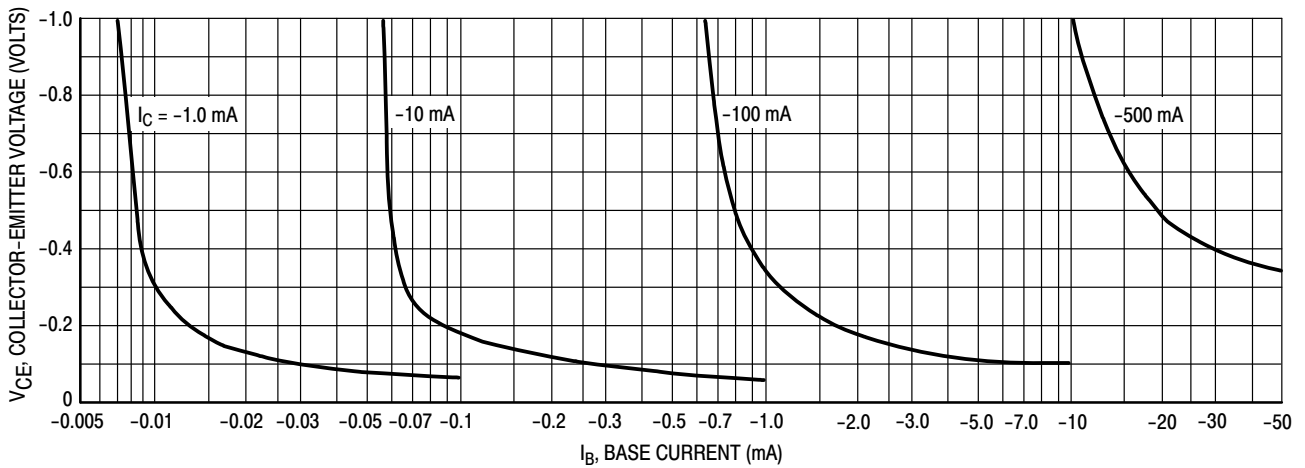

Figure 4. Collector Saturation Region

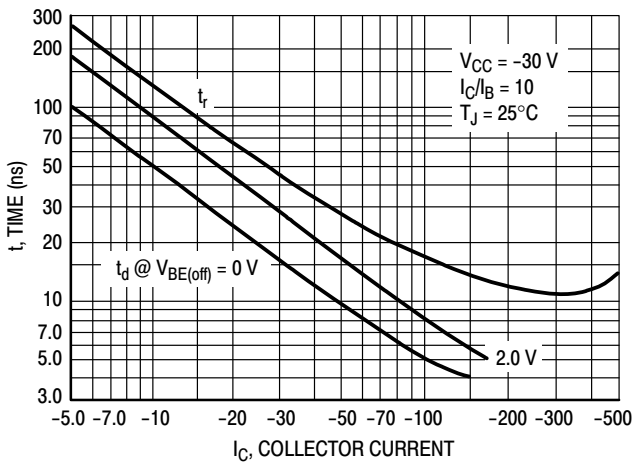

Figure 5. Turn-On Time

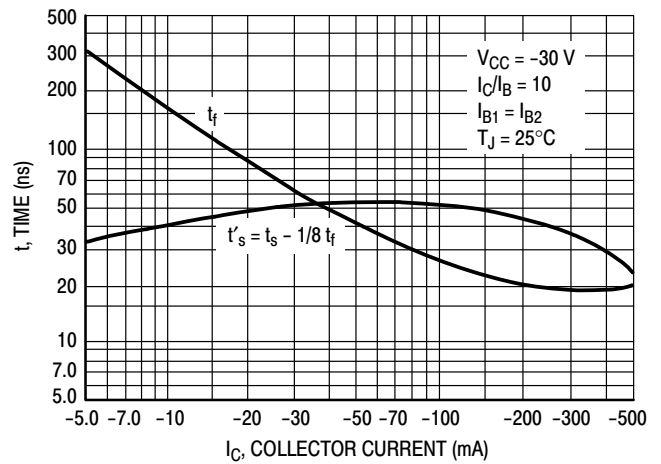

Figure 6. Turn-Off Time

TYPICAL SMALL-SIGNAL CHARACTERISTICS

NOISE FIGURE

$V_{CE} = 10 \text{ Vdc}$, $T_A = 25^\circ\text{C}$

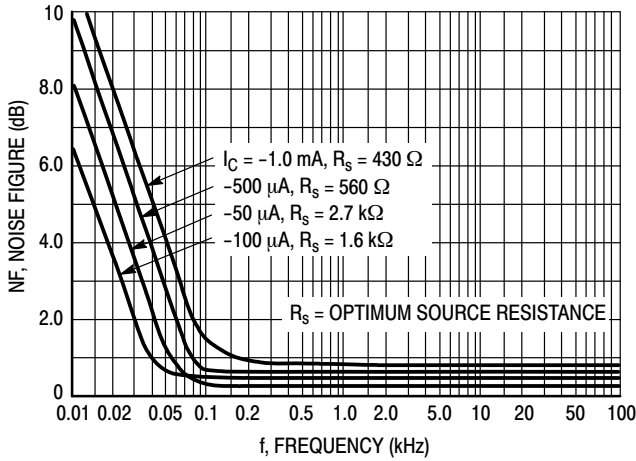

Figure 7. Frequency Effects

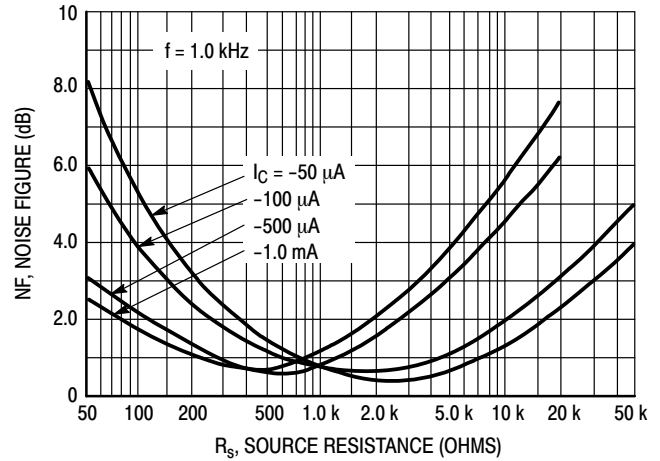

Figure 8. Source Resistance Effects

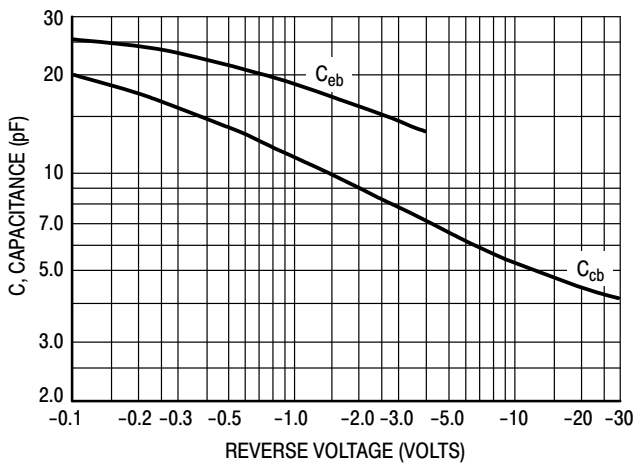

Figure 9. Capacitances

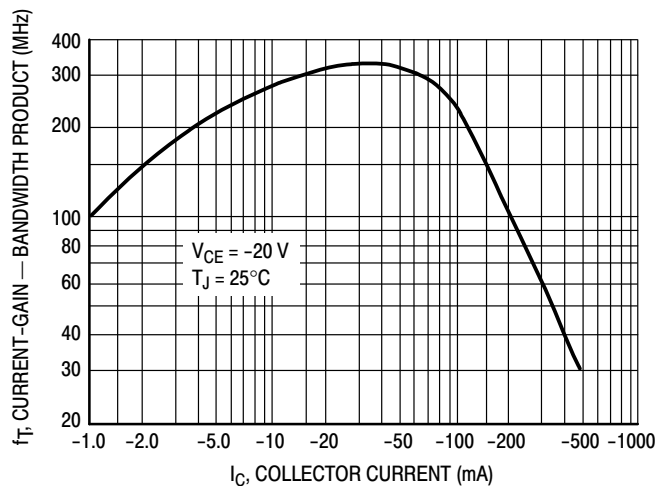

Figure 10. Current-Gain - Bandwidth Product

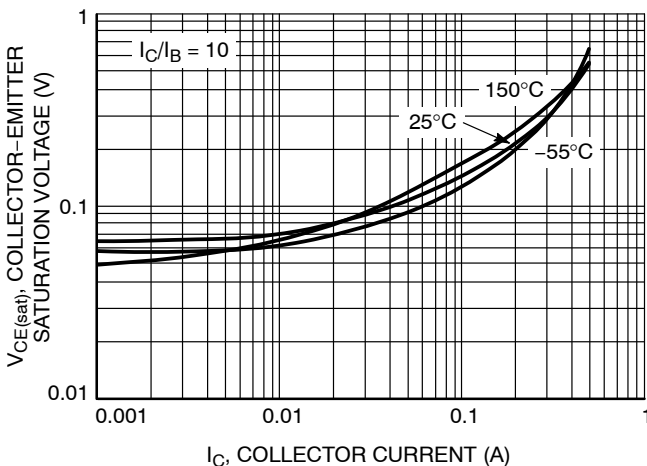

Figure 11. Collector-Emitter Saturation Voltage vs. Collector Current

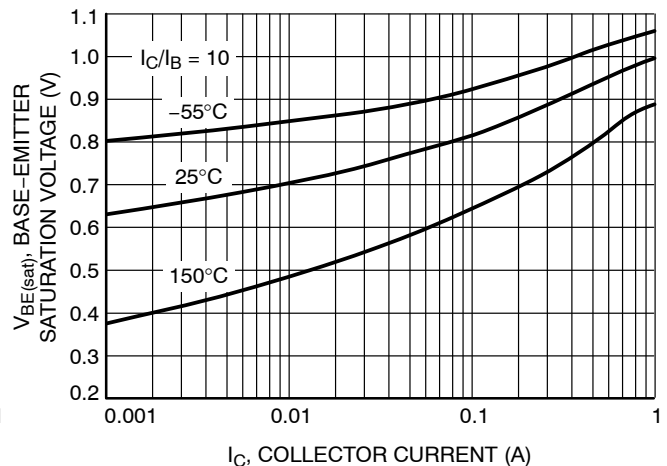

Figure 12. Base-Emitter Saturation Voltage vs. Collector Current

TYPICAL SMALL-SIGNAL Characteristics
NOISE FIGURE

$V_{CE} = 10 \text{ Vdc}$, $T_A = 25^\circ\text{C}$

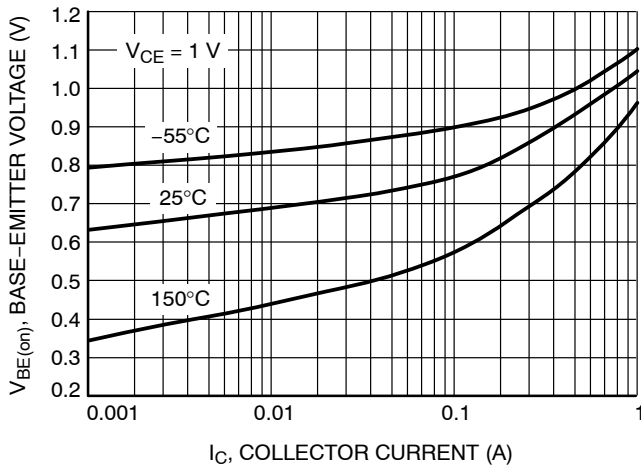

Figure 13. Base Emitter Voltage vs. Collector Current

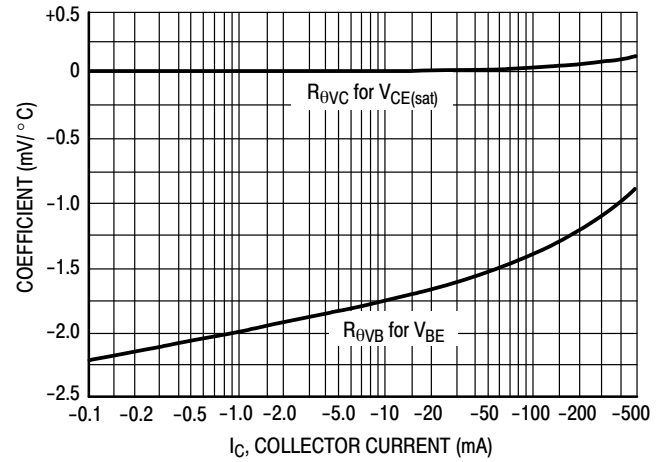

Figure 14. Temperature Coefficients

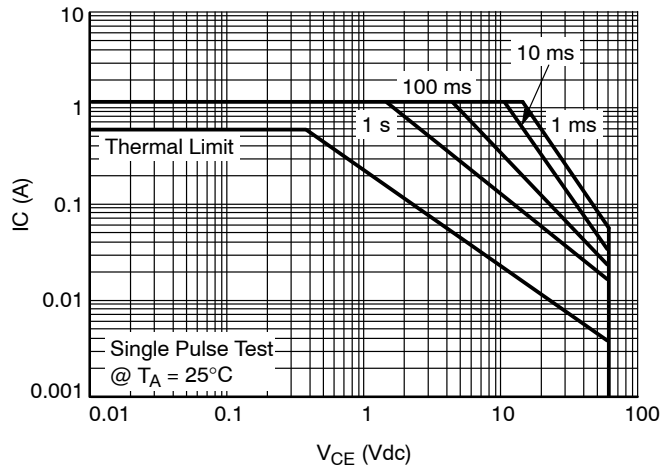
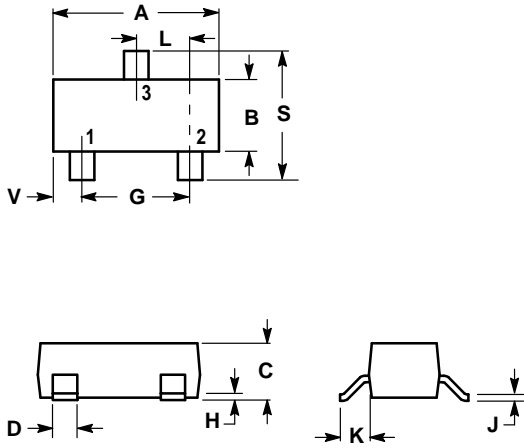

Figure 15. Safe Operating Area

LMBT2907LT1G LMBT2907ALT1G
S-LMBT2907LT1G S-LMBT2907ALT1G

SOT-23



NOTES:

1. DIMENSIONING AND TOLERANCING PER ANSI Y14.5M, 1982.
2. CONTROLLING DIMENSION: INCH.

DIM	INCHES		MILLIMETERS	
	MIN	MAX	MIN	MAX
A	0.1102	0.1197	2.80	3.04
B	0.0472	0.0551	1.20	1.40
C	0.0350	0.0440	0.89	1.11
D	0.0150	0.0200	0.37	0.50
G	0.0701	0.0807	1.78	2.04
H	0.0005	0.0040	0.013	0.100
J	0.0034	0.0070	0.085	0.177
K	0.0140	0.0285	0.35	0.69
L	0.0350	0.0401	0.89	1.02
S	0.0830	0.1039	2.10	2.64
V	0.0177	0.0236	0.45	0.60

- PIN 1. BASE
 2. EMITTER
 3. COLLECTOR

