



## **5A Synchronous buck Converter**

### ❖ GENERAL DESCRIPTION

AX3122 consists of step-down switching regulator with synchronous PWM converter. These device include a reference voltage source, oscillation circuit, error amplifier, internal PMOS and external NMOS etc.

AX3122 provides 5A high current, low-ripple power, high efficiency, and excellent transient characteristics. The PWM control circuit is able to the duty ratio linearly form 0 up to 100%. An over current protect function and short circuit protect function are built inside, and when OCP or SCP happens, the operation frequency will be reduced. Also, an external compensation is easily to system stable.

With the addition of internal PMOS, external NMOS, a coil and capacitors externally, these ICs can function as step-down switching regulators. The device serve 5A high power supply system, the external NMOS can reduce IC temperature and promote system efficiency for heavy load. Since this converter can accommodate an input voltage up to 23V.

### ❖ FEATURES

- Input voltage : 4.5V to 23V
- Output voltage :  $V_{FB}$  to  $V_{CC}$
- Duty ratio : 0% to 100% PWM control
- Oscillation frequency : 250KHz typ.
- Current Limit (CL).
- Thermal Shutdown function.
- Short Circuit Protect (SCP).
- Built-in internal P-channel MOS and drive external N-channel MOS.
- SOP-8L with Exposed Pad Pb-Free package.

❖ BLOCK DIAGRAM

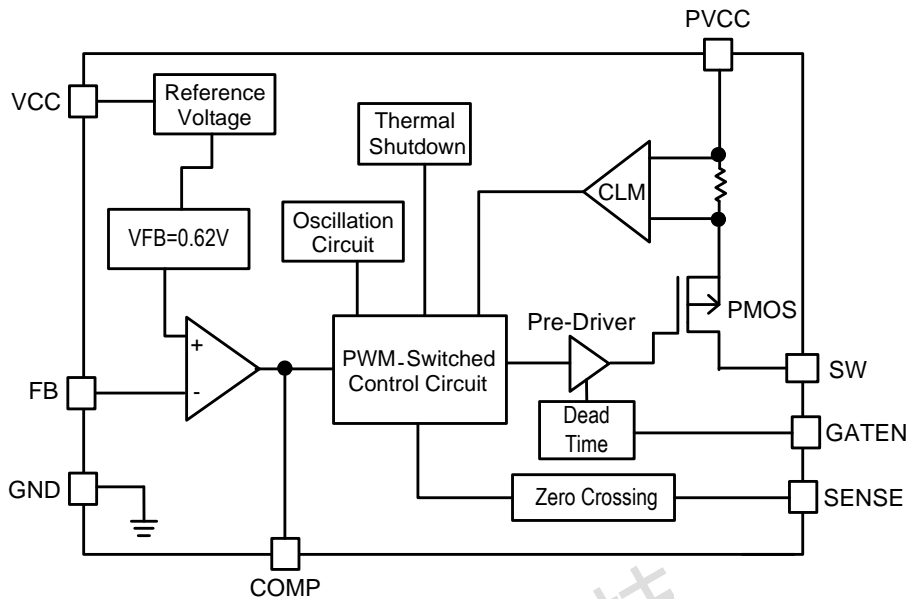

❖ PIN ASSIGNMENT

The package of AX3122 is SOP-8L-EP; the pin assignment is given by:

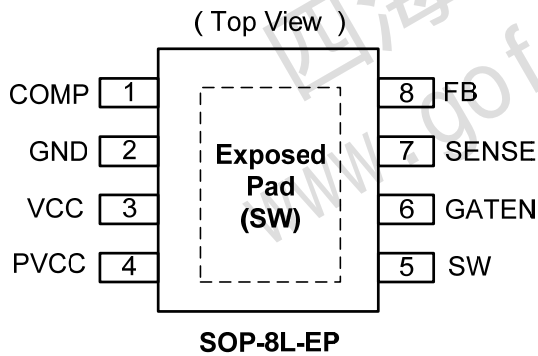

Name	Description
COMP	Compensation pin
GND	Ground pin
VCC	IC power supply pin
PVCC	Driver power supply pin
SW	Switch pin. Connect external inductor here.
GATEN	NMOS control pin
SENSE	Zero-crossing sense input pin
FB	Feedback pin

❖ ORDER/MARKING INFORMATION

Order Information	Top Marking
<p><b>AX3122 XX X</b></p> <p>Package Type: ES: SOP-8L-EP</p> <p>Packing: Blank : Tube, A : Taping</p>	<p>Logo ← <b>AX</b> 3 1 2 2 → Part number</p> <p>YY WW X → ID code:internal</p> <p>WW: 01~52</p> <p>Year: 10=2010, 11=2011</p>

### ❖ ABSOLUTE MAXIMUM RATINGS (at T<sub>A</sub>=25°C)

Characteristics	Symbol	Rating	Unit
VCC,PVCC Pin Voltage	V <sub>CC</sub>	V <sub>SS</sub> - 0.3 to V <sub>SS</sub> + 24	V
Feedback Pin Voltage	V <sub>FB</sub>	V <sub>SS</sub> - 0.3 to V <sub>CC</sub>	V
GATEN Pin Voltage	V <sub>GATEN</sub>	V <sub>SS</sub> - 0.3 to V <sub>CC</sub>	V
SENSE Pin Voltage	V <sub>SENSE</sub>	V <sub>SS</sub> - 0.3 to V <sub>CC</sub>	V
COMP Pin Voltage	V <sub>COMP</sub>	V <sub>SS</sub> - 0.3 to 5	V
Switch Pin Voltage	V <sub>SW</sub>	V <sub>SS</sub> - 0.8 to V <sub>CC</sub> + 0.3	V
Power Dissipation	PD	Internally limited	mW
Storage Temperature Range	T <sub>ST</sub>	-40 to +165	°C
Junction Temperature Range	T <sub>J</sub>	-40 to +150	°C
Operating Supply Voltage	V <sub>OP</sub>	4.5 to 23	V
Thermal Resistance from Junction to case	θ <sub>JC</sub>	15	°C/W
Thermal Resistance from Junction to ambient	θ <sub>JA</sub>	40	°C/W

Note: θ<sub>JA</sub> is measured with the PCB copper area(need connect to Exposed pad) of approximately 1 in<sup>2</sup>(Multi-layer).

### ❖ ELECTRICAL CHARACTERISTICS

(V<sub>IN</sub> = 12V, V<sub>OUT</sub>=3.3V, T<sub>A</sub> =25°C, unless otherwise specified)

Characteristics	Symbol	Conditions	Min	Typ	Max	Units
Feedback Voltage	V <sub>FB</sub>	I <sub>OUT</sub> =0.1A	0.605	0.620	0.635	V
Feedback Bias Current	I <sub>FB</sub>	I <sub>OUT</sub> =0.1A	-	0.1	0.5	uA
Quiescent Current	I <sub>CCQ</sub>	V <sub>FB</sub> =1.2V force driver off	-	6	8	mA
Switch Current Limit	I <sub>SW-Lim</sub>		5.5	-	-	A
Line Regulation	ΔV <sub>OUT</sub> /V <sub>OUT</sub>	V <sub>IN</sub> = 4.5V~23V, I <sub>OUT</sub> =0.2A	-	0.1	0.5	%
Load Regulation	ΔV <sub>OUT</sub> /V <sub>OUT</sub>	I <sub>OUT</sub> = 0.1A to 5A	-	0.1	0.5	%
Oscillation Frequency	F <sub>OSC</sub>	SW pin	200	250	300	KHz
Short Oscillation Frequency	F <sub>OSC1</sub>	V <sub>FB</sub> <0.4V	-	60	-	KHz
Dead Time	T <sub>DR</sub>	Rising	-	50	-	nS
	T <sub>DF</sub>	Falling	-	50	-	
Internal PMOS R <sub>DSON</sub>	R <sub>DSON</sub> -P	V <sub>IN</sub> =5V, V <sub>FB</sub> =0V	-	90	150	mΩ
		V <sub>IN</sub> =12V, V <sub>FB</sub> =0V	-	50	120	
GATEN driving time	T <sub>Drive</sub>	Rising, C <sub>GATE</sub> =1000pF	-	80	-	nS
		Falling, C <sub>GATE</sub> =1000pF	-	60	-	nS
Thermal Shutdown	T <sub>SD</sub>		-	150	-	°C
Thermal Shutdown Hysteresis	T <sub>SH</sub>		-	30	-	°C

❖ APPLICATION CIRCUIT

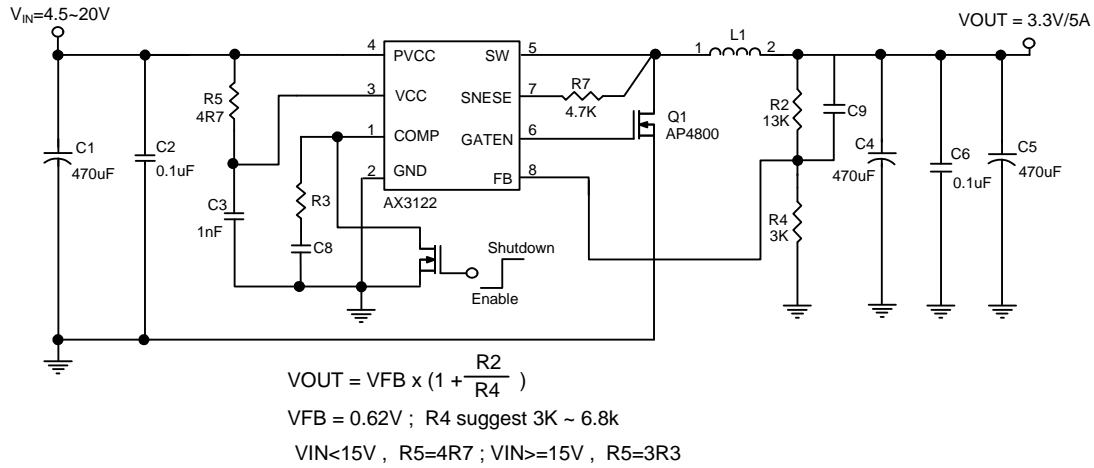

COUT ESR Range	V <sub>IN</sub>	V <sub>OUT</sub>	R3(Ω)	C8	C9
30m~80mΩ	4.5V~20V	1.2V~5V	1.2K	10n	2.2n
80m~300mΩ	4.5V~20V	1.2V~5V	820	10n	560p

❖ FUNCTION DESCRIPTIONS

PWM Control

The AX3122 consists of DC/DC converters that employ a synchronous pulse-width modulation (PWM) system. The synchronous converter is built inside PMOS and outside control NMOS in order to reduce IC temperature for heavy load. In converters of the AX3122, the pulse width varies in a range from 0 to 100%, according to the load current. The ripple voltage produced by the switching can easily be removed through a filter because the switching frequency remains constant. Therefore, these converters provide a low-ripple power over broad ranges of input voltage and load current.

Setting the Output Voltage

Application circuit item shows the basic application circuit with adjustable output version. The external resistor sets the output voltage according to the following equation:

$$V_{OUT} = 0.62V \times \left(1 + \frac{R2}{R4}\right)$$

Table 1 Resistor select for output voltage setting

V <sub>OUT</sub>	R4	R2
5.0V	4.7K	33K
3.3V	3K	13K
2.5V	3.3K	10K
1.8V	6.8K	13K
1.5V	3.3K	4.7K
1.184V	3.3K	3.0K
1.0V	3.3K	2.0K

### COMP

Compensation pin. The COMP pin connects R3 and C8 to GND for all condition. In Low ESR output capacitor, R3=1.2KΩ and C8=10nF. When ESR>80mΩ, R3 can be changed to 820Ω. Please refer the application circuit table.

### Inductor Selection

For most designs, the inductor is suggested 22μH to 33μH. Please refer the below table to design.

L1 recommend value (V <sub>IN</sub> =12V ,I <sub>OUT</sub> =5A)					
V <sub>OUT</sub>	1.2V	1.8V	2.5V	3.3V	5V
L1 Value	22uH	22H	22uH	33uH	33uH

Where is inductor Ripple Current. Large value inductors lower ripple current and small value inductors result in high ripple currents. Choose inductor ripple current approximately 15% of the maximum load current 5A, ΔI<sub>L</sub>=0.75A. The DC current rating of the inductor should be at least equal to the maximum load current plus half the ripple current to prevent core saturation (5A+0.375A).

### Input Capacitor Selection

The input capacitor reduces the surge current drawn from the input and switching noise from the device. The input capacitor impedance at the switching frequency shall be less than input source impedance to prevent high frequency switching current passing to the input. A low ESR input capacitor sized for maximum RMS current must be used.

The capacitor voltage rating should be at least 1.5 times greater than the input voltage, and often much higher voltage ratings are needed to satisfy.

## Output Capacitor Selection

The output capacitor is required to keep the output voltage ripple small and to ensure regulation loop stability. The output capacitor must have low impedance at the switching frequency. A low ESR capacitor sized for maximum RMS current must be used. The low ESR requirements needed for low output ripple voltage. In heavy load, the two parallel 470uF of output capacitor is must be used that can be system more stability.

The capacitor voltage rating should be at least 1.5 times greater than the input voltage, and often much higher voltage ratings are needed to satisfy.

## Layout Guidance (please refer layout picture)

When laying out the PC board, the following suggestions should be taken to ensure proper operation of the AX3122. These items are also illustrated graphically in below.

1. The power traces, including the source trace, the output trace and the inductor trace should be kept short, direct and wide to allow large current flow.
2. The power ground is keep input capacitor's (C1) ground closed and far away signal ground.
3. The C3 bypass capacitor must be closed to V<sub>CC</sub> and GND pin.
4. The exposed pad is connecting to SW trace closely and widely. (Reduce IC temperature)
5. Do not trace signal line under inductor.

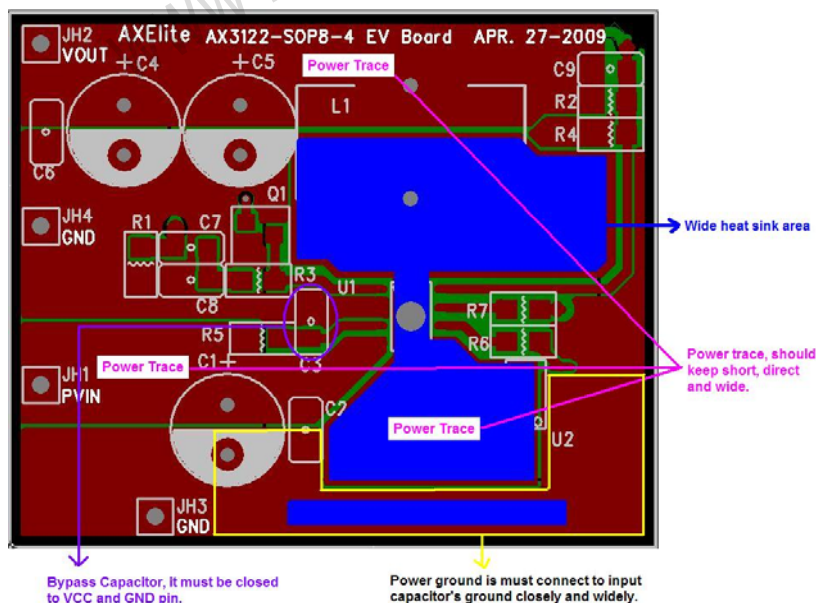

(AX3122 PCB Layout -Top View)

❖ TYPICAL CHARACTERISTICS

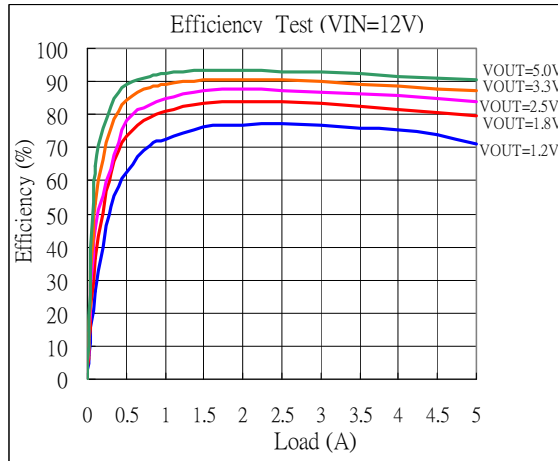
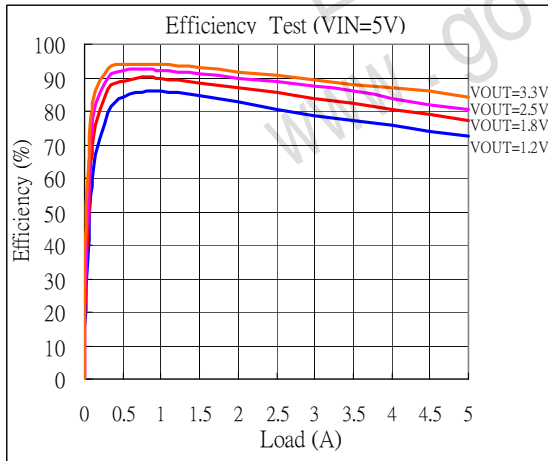
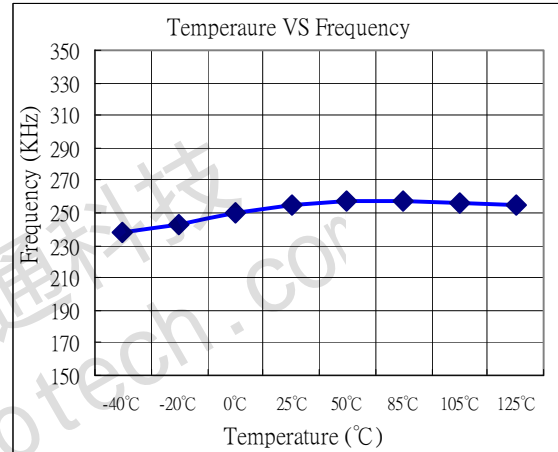
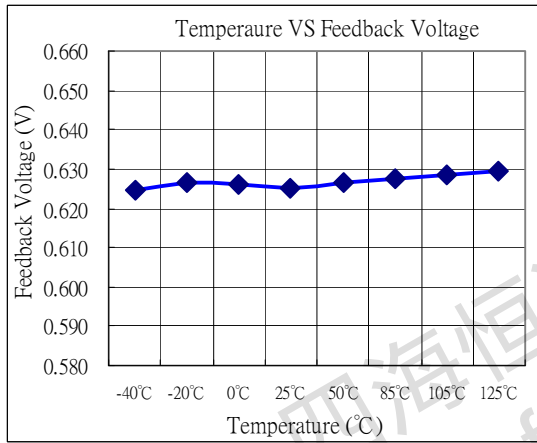
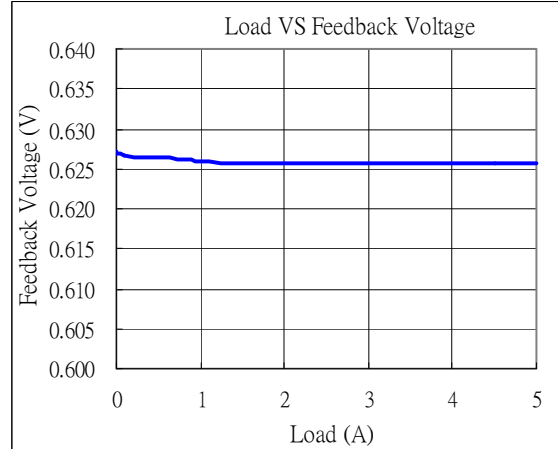
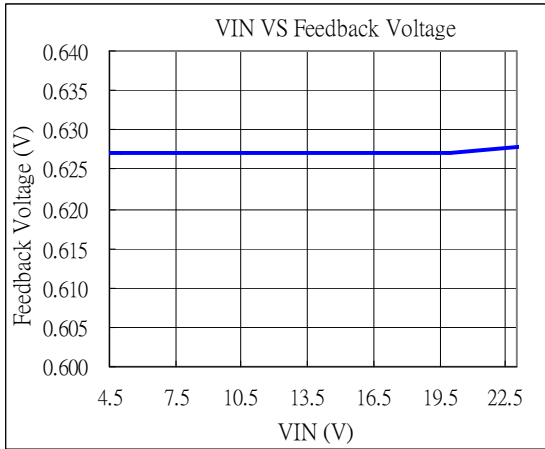

❖ TYPICAL CHARACTERISTICS (CONTINUES)

Power-ON Wave  
(VIN=12V, VOUT=2.5V, Load=5A)

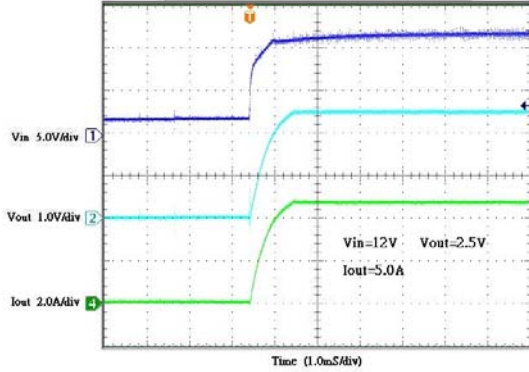

Power-ON Wave  
(VIN=5V, VOUT=1.2V, Load=5A)

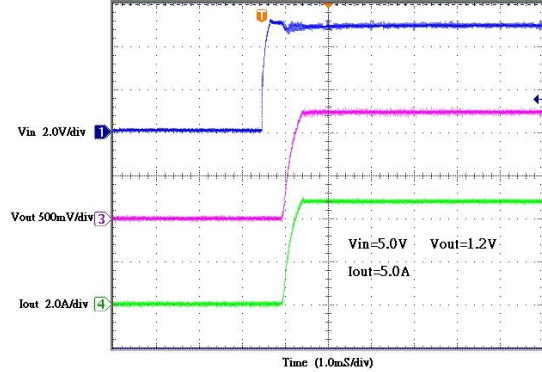

Load Transient  
(VIN=12V, VOUT=2.5V, Load=0.5~4.5A)

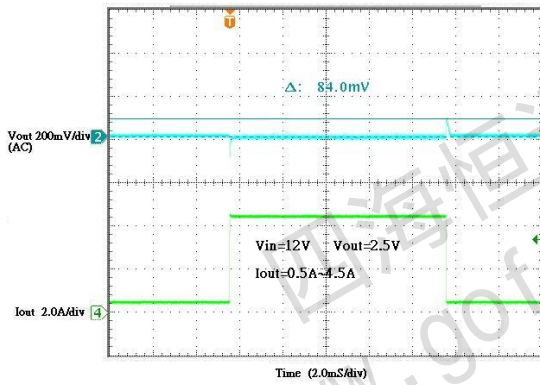

Load Transient  
(VIN=5V, VOUT=1.2V, Load=0.5~4.5A)

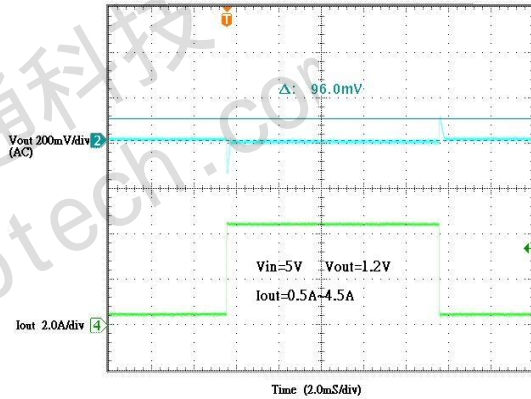



❖ PACKAGE OUTLINES

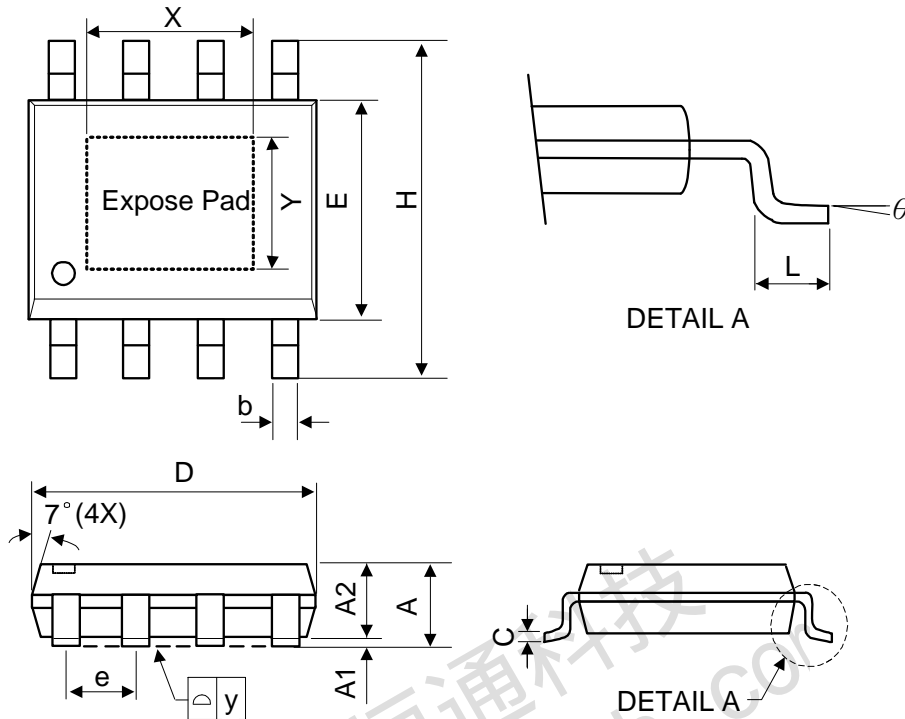

Symbol	Dimensions in Millimeters			Dimensions in Inches		
	Min.	Nom.	Max.	Min.	Nom.	Max.
A	-	-	1.75	-	-	0.069
A1	0	-	0.15	0	-	0.06
A2	1.25	-	-	0.049	-	-
C	0.1	0.2	0.25	0.0075	0.008	0.01
D	4.7	4.9	5.1	0.185	0.193	0.2
E	3.7	3.9	4.1	0.146	0.154	0.161
H	5.8	6	6.2	0.228	0.236	0.244
L	0.4	-	1.27	0.015	-	0.05
b	0.31	0.41	0.51	0.012	0.016	0.02
e	1.27 BSC			0.050 BSC		
y	-	-	0.1	-	-	0.004
X	-	2.34	-	-	0.092	-
Y	-	2.34	-	-	0.092	-
θ	0°	-	8°	0°	-	8°

Mold flash shall not exceed 0.25mm per side  
JEDEC outline: MS-012 BA