

Applications

- Mobile Infrastructure
- CATV / DBS
- Defense / Homeland Security



SOT-89 Package

Product Features

- 50 – 1500 MHz
- +47 dBm Output IP3
- 13.5 dB Gain
- +26.5 dBm P1dB
- MTTF > 1000 Years
- Internally Matched
- Single +9 V Supply
- Lead-free/RoHS-compliant SOT-89 Package

Functional Block Diagram

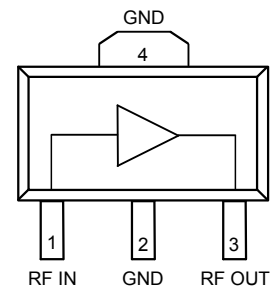

General Description

The AH101-G is a medium power gain block that offers excellent dynamic range in a low-cost surface mount package. The combination of a single supply voltage and an internally matched device makes it ideal for both narrow and broadband applications. Only dc blocking and bypass capacitors as well as an RF choke are required for operation.

Superior thermal design allows the product to achieve +46 dBm IP3 performance at a mounting temperature of +85°C with an associated MTTF of greater than 1000 years.

This broadband amplifier uses a high reliability GaAs MESFET technology and is targeted for applications where high linearity is required. The AH101-G is available in the environmentally-friendly green/RoHS-compliant SOT-89 package.

Pin Configuration

Pin No.	Label
1	RF In
3	RF Out
2, 4	GND

Not Recommended for New Designs

Recommended Replacement Part:
TQP7M9102

Ordering Information

Part No.	Description
AH101-G	Med. Power High Linearity Amplifier

Standard T/R size = 1000 pieces on a 7" reel

Absolute Maximum Ratings

Parameter	Rating
Storage Temperature	-55 to 150°C
RF Input Power, CW, 50Ω, T=25°C	+18 dBm
Supply Voltage (V _{DD})	+11 V

Operation of this device outside the parameter ranges given above may cause permanent damage.

Recommended Operating Conditions

Parameter	Min	Typ	Max	Units
Supply Voltage (V _{DD})	7	9	10	V
T _{CASE}	-40		+85	°C
T _j for >10 ⁶ hours MTTF			+160	°C

Electrical specifications are measured at specified test conditions. Specifications are not guaranteed over all recommended operating conditions.

Electrical Specifications

Test conditions unless otherwise noted: V_{DD} = +9V, Temp = +25°C, 50 Ω system.

Parameter	Conditions	Min	Typ	Max	Units
Operational Frequency Range		50		1500	MHz
Test Frequency			800		MHz
Gain		12	13.5	16	dB
Input Return Loss			20		dB
Output Return Loss			15		dB
Output P1dB			+26.5		dBm
Output IP3	P _{out} = +8 dBm/tone, Δf = 10 MHz	+43	+47		dBm
Noise Figure			3.5		dB
Current, I _{DD}		170	200	230	mA
Thermal Resistance, θ _{jc}	Junction to backside ground paddle			25	°C/W

S-Parameters

Test Conditions: V_{DD} = +9 V, I_{DD} = 200 mA (typ.), T = +25°C, unmatched 50 ohm system, calibrated to device leads

Freq (MHz)	S11 (dB)	S11 (ang)	S21 (dB)	S21 (ang)	S12 (dB)	S12 (ang)	S22 (dB)	S22 (ang)
50	-18.92	-60.71	13.78	168.24	-19.25	4.11	-14.51	-160.07
100	-22.31	-52.06	13.63	169.87	-19.13	0.17	-14.86	-177.29
200	-23.85	-47.09	13.50	166.42	-19.17	-5.09	-15.22	164.61
400	-23.32	-62.31	13.48	157.06	-19.28	-12.63	-14.83	140.14
600	-21.73	-77.34	13.32	146.40	-19.36	-19.07	-14.55	118.64
800	-20.76	-90.04	13.19	135.74	-19.47	-25.94	-14.02	97.71
1000	-19.65	-105.39	13.05	124.67	-19.74	-33.10	-13.40	80.17
1200	-18.62	-121.62	12.94	114.96	-20.07	-39.77	-12.95	63.09
1400	-17.32	-131.81	12.76	104.01	-20.36	-45.37	-12.44	47.65
1600	-16.53	-141.33	12.55	93.98	-20.44	-53.24	-12.02	31.14

Typical Performance – 50-1500 MHz

Test conditions unless otherwise noted: $V_{DD} = +9V$, $I_{DD} = 200\text{ mA}$ (typ.), $Temp = +25^\circ C$

Parameter	Typical Value				Units
Frequency	50	450	900	1500	MHz
Gain	13.6	13.8	13.5	12.7	dB
Input Return Loss	23	27	21	14	dB
Output Return Loss	8	14	18	16	dB
Output P1dB	+26.1	+26.5	+26.5	+25	dBm
Output IP3 (Pout= +8 dBm/tone, $\Delta f = 10\text{ MHz}$)	+45	+47	+47	+47	dBm
Output IP2	+63	+63	+60	+59	dBm
Noise Figure	4.4	3.4	3.6	4.2	dB

Performance Plots – 50-1500 MHz

Test conditions unless otherwise noted: $V_{DD} = +5V$, $I_{DD} = 85\text{ mA}$ (typ.), $Temp = +25^\circ C$

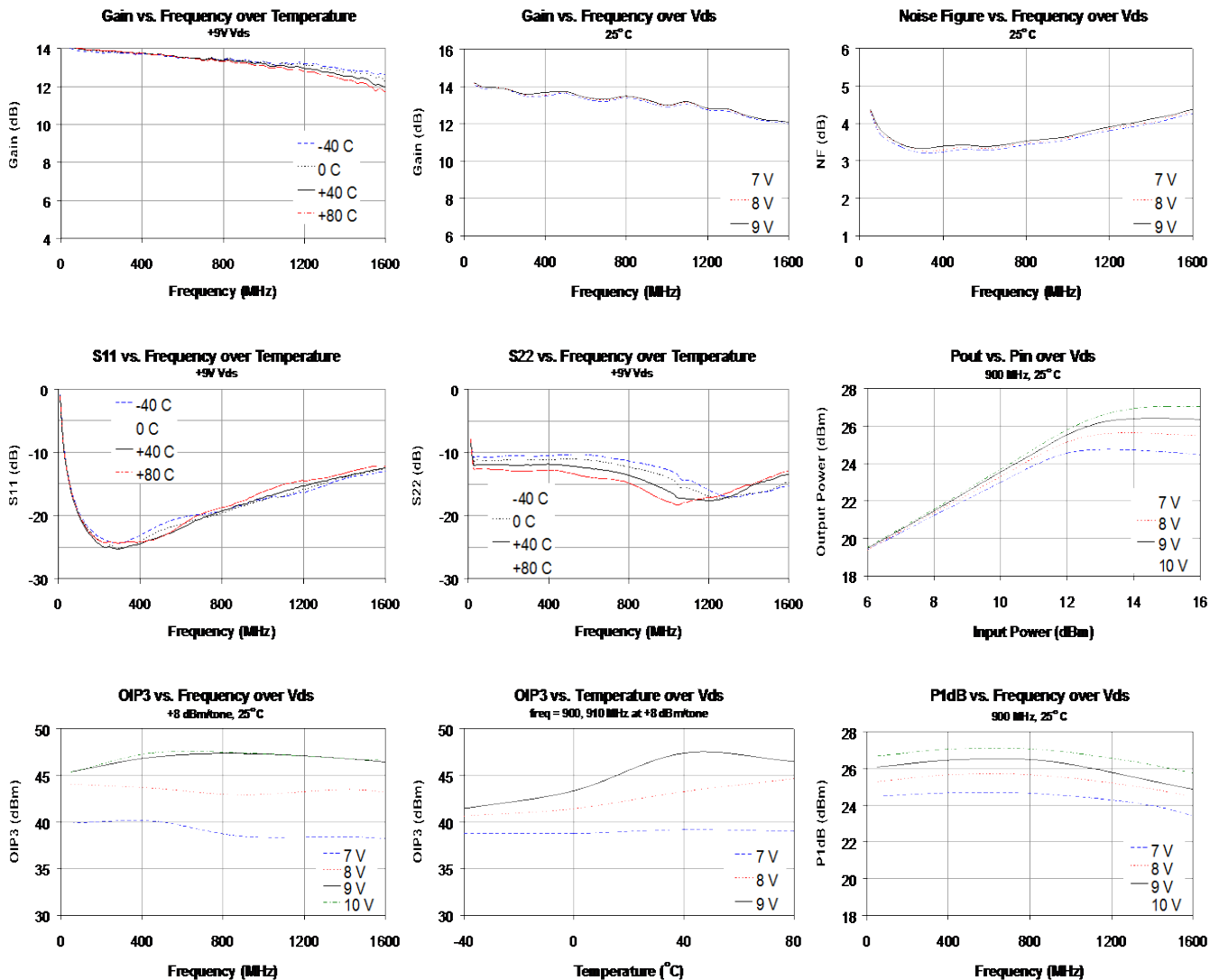

AH101-PCB Evaluation Board (50–1500 MHz)

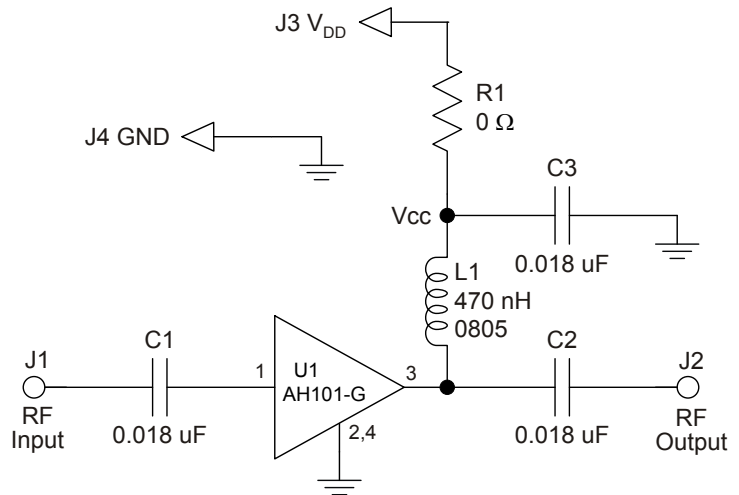
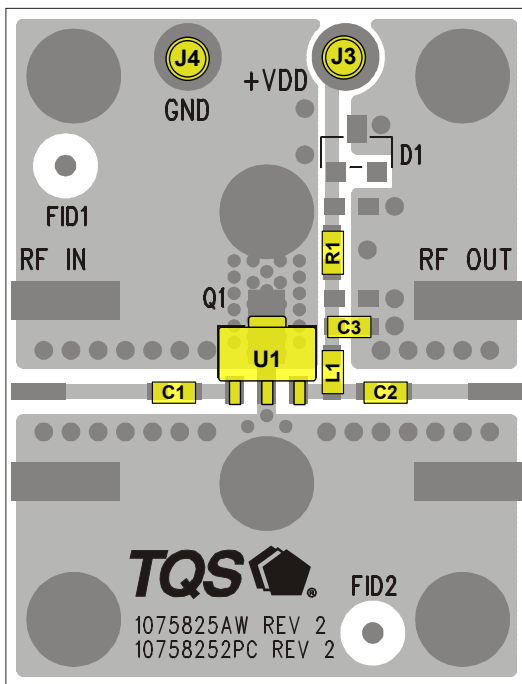

Notes:

1. See Evaluation Board PCB Information for material and stack-up.
2. R1 (0 Ω jumper) may be replaced with copper trace in the target application layout.
3. All components are 0603 size unless stated on the schematic.
4. The amplifier should be connected directly to a +9 V regulator; no dropping resistor is required.
5. If no DC signal is present at the input (pin 1), C1 can be removed. The gate (input pin) is internally grounded in the amplifier.
6. For higher frequencies of operation, use a lower value L2 inductor.

Performance Plots – AH101-PCB

Test conditions unless otherwise noted: $V_{DD} = +9V$, $I_{DD} = 200$ mA (typ.), Temp = +25°C

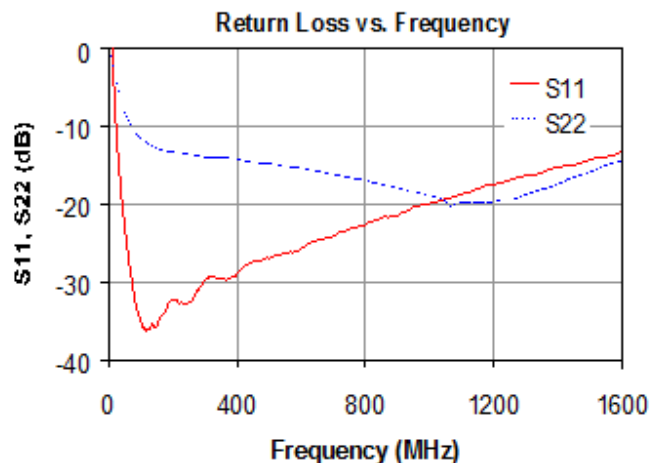
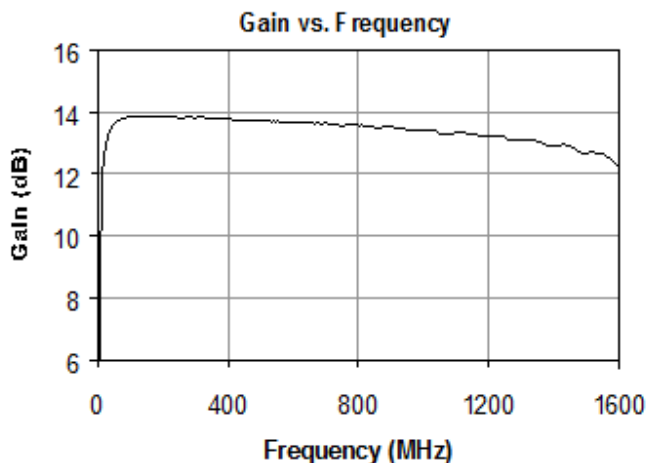

Pin Configuration and Description

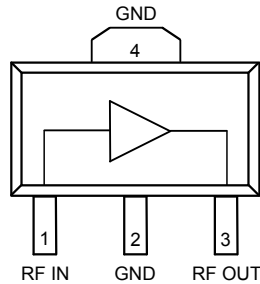

Pin No.	Label	Description
1	RF In	RF input, matched to 50 ohms. External DC Block is required.
3	RF Out	RF output / DC supply, matched to 50 ohms. External DC Block, bias choke required.
2, 4	GND	Backside Paddle. Multiple vias should be employed to minimize inductance and thermal resistance; see PCB mounting pattern in Mechanical Information section.

Evaluation Board PCB Information

TriQuint PCB 1075825 Material and Stack-up

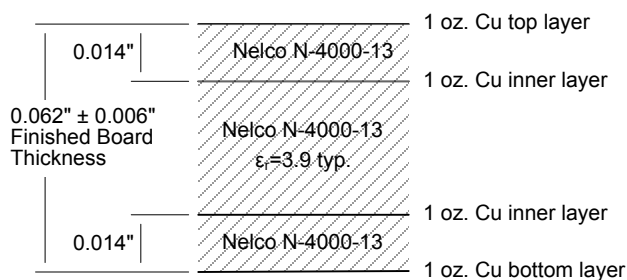

50 ohm line dimensions: width = 0.029", spacing = 0.035"

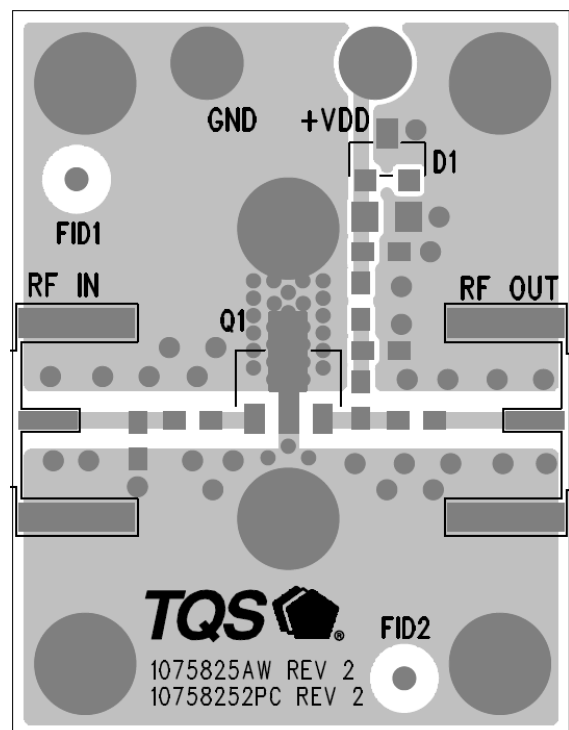

Product Compliance Information

ESD Sensitivity Ratings



Caution! ESD-Sensitive Device

ESD Rating: Class 1C
Value: Passes ≥ 1000 V min.
Test: Human Body Model (HBM)
Standard: JEDEC Standard JESD22-A114

ESD Rating: Class IV
Value: Passes ≥ 1000 V
Test: Charged Device Model (CDM)
Standard: JEDEC Standard JESD22-C101

MSL Rating

MSL Rating: Level 1
Test: 260°C convection reflow
Standard: JEDEC Standard IPC/JEDEC J-STD-020

Solderability

Compatible with both lead-free (260 °C max. reflow temperature) and tin/lead (245 °C max. reflow temperature) soldering processes.

Contact plating: NiPdAu

RoHS Compliance

This part is compliant with EU 2002/95/EC RoHS directive (Restrictions on the Use of Certain Hazardous Substances in Electrical and Electronic Equipment).

This product also has the following attributes:

- Lead Free
- Halogen Free (Chlorine, Bromine)
- Antimony Free
- TBBP-A (C₁₅H₁₂Br₄O₂) Free
- PFOS Free
- SVHC Free

Contact Information

For the latest specifications, additional product information, worldwide sales and distribution locations, and information about TriQuint:

Web: www.triquint.com Tel: +1.503.615.9000
Email: info-sales@triquint.com Fax: +1.503.615.8902

For technical questions and application information:

Email: sjcappliations.engineering@triquint.com

Important Notice

The information contained herein is believed to be reliable. TriQuint makes no warranties regarding the information contained herein. TriQuint assumes no responsibility or liability whatsoever for any of the information contained herein. TriQuint assumes no responsibility or liability whatsoever for the use of the information contained herein. The information contained herein is provided "AS IS, WHERE IS" and with all faults, and the entire risk associated with such information is entirely with the user. All information contained herein is subject to change without notice. Customers should obtain and verify the latest relevant information before placing orders for TriQuint products. The information contained herein or any use of such information does not grant, explicitly or implicitly, to any party any patent rights, licenses, or any other intellectual property rights, whether with regard to such information itself or anything described by such information.

TriQuint products are not warranted or authorized for use as critical components in medical, life-saving, or life-sustaining applications, or other applications where a failure would reasonably be expected to cause severe personal injury or death.