



N-Channel Enhancement Mode Field Effect Transistor

PRODUCT SUMMARY

V _{DS}	I _D	R _{DS(ON)} (Ω) Typ
400V	4A	2.1 @ V _{GS} =10V

FEATURES

- Super high dense cell design for low R_{DS(ON)}.
- Rugged and reliable.
- Surface Mount Package.

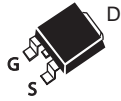
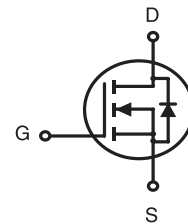
SDU SERIES
TO-252(D-PAK)SDD SERIES
TO-251S(I-PAK)SDD SERIES
TO-251L(I-PAK)

ORDERING INFORMATION

Ordering Code	Package	Marking Code	Delivery Mode	RoHS Status
SDU05N04HZ	TO-252	SDU05N04	Reel	Halogen Free
SDD05N04HS	TO-251S	SDD05N04	Tube	Halogen Free
SDD05N04HL	TO-251L	SDD05N04	Tube	Halogen Free

ABSOLUTE MAXIMUM RATINGS (T_C=25°C unless otherwise noted)

Symbol	Parameter	Limit	Units
V _{DS}	Drain-Source Voltage	400	V
V _{GS}	Gate-Source Voltage	±30	V
I _D	Drain Current-Continuous ^a	T _C =25°C	4
		T _C =70°C	3.3
I _{DM}	-Pulsed ^b	12	A
E _{AS}	Single Pulse Avalanche Energy ^d	2.5	mJ
P _D	Maximum Power Dissipation	T _C =25°C	68
		T _C =70°C	48
T _J , T _{STG}	Operating Junction and Storage Temperature Range	-55 to 175	°C

THERMAL CHARACTERISTICS

R _{θJC}	Thermal Resistance, Junction-to-Case ^a	2.2	°C/W
R _{θJA}	Thermal Resistance, Junction-to-Ambient ^a	50	°C/W

SDU/D05N04

Ver 1.2

ELECTRICAL CHARACTERISTICS (T_C=25°C unless otherwise noted)

Symbol	Parameter	Conditions	Min	Typ	Max	Units
OFF CHARACTERISTICS						
BV _{DSS}	Drain-Source Breakdown Voltage	V _{GS} =0V , I _D =250uA	400			V
I _{DSS}	Zero Gate Voltage Drain Current	V _{DS} =320V , V _{GS} =0V			1	uA
I _{GSS}	Gate-Body Leakage Current	V _{GS} = ±30V , V _{DS} =0V			±100	nA
ON CHARACTERISTICS						
V _{GS(th)}	Gate Threshold Voltage	V _{DS} =V _{GS} , I _D =250uA	2	3	4	V
R _{DS(ON)}	Drain-Source On-State Resistance	V _{GS} =10V , I _D =2A		2.1	2.6	ohm
g _{FS}	Forward Transconductance	V _{DS} =20V , I _D =2A		1.6		S
DYNAMIC CHARACTERISTICS ^c						
C _{ISS}	Input Capacitance	V _{DS} =25V, V _{GS} =0V f=1.0MHz		320		pF
C _{OSS}	Output Capacitance			44		pF
C _{RSS}	Reverse Transfer Capacitance			7.9		pF
SWITCHING CHARACTERISTICS ^c						
t _{D(ON)}	Turn-On Delay Time	V _{DD} =200V I _D =1A V _{GS} =10V R _{GEN} =6 ohm		16		ns
t _r	Rise Time			12.5		ns
t _{D(OFF)}	Turn-Off Delay Time			19		ns
t _f	Fall Time			5		ns
Q _g	Total Gate Charge	V _{DS} =100V, I _D =1A, V _{GS} =10V		5.7		nC
Q _{gs}	Gate-Source Charge	V _{DS} =100V, I _D =1A, V _{GS} =10V		1.4		nC
Q _{gd}	Gate-Drain Charge			2.3		nC
DRAIN-SOURCE DIODE CHARACTERISTICS AND MAXIMUM RATINGS						
V _{SD}	Diode Forward Voltage	V _{GS} =0V, I _S =1A		0.79	1.4	V
Notes a.Surface Mounted on FR4 Board,t < 10sec. b.Pulse Test:Pulse Width ≤ 300us, Duty Cycle ≤ 2%. c.Guaranteed by design, not subject to production testing. d.Starting T _J =25°C,L=5mH,V _{DD} = 50V.(See Figure13)						

Dec,24,2013

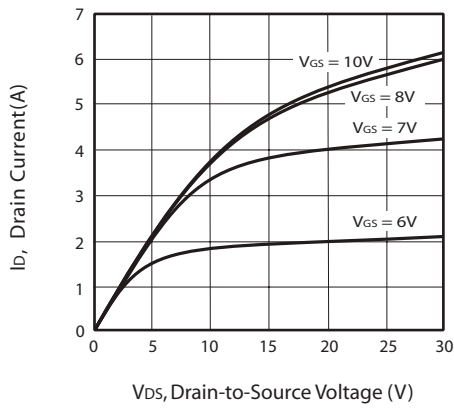

Figure 1. Output Characteristics

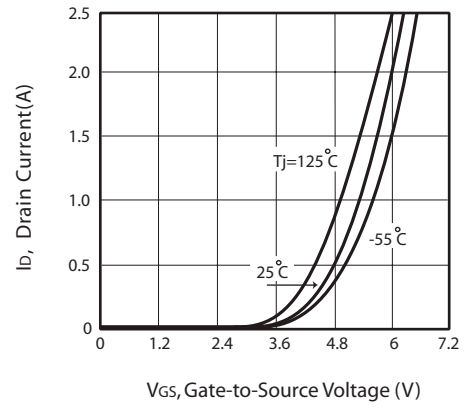

Figure 2. Transfer Characteristics

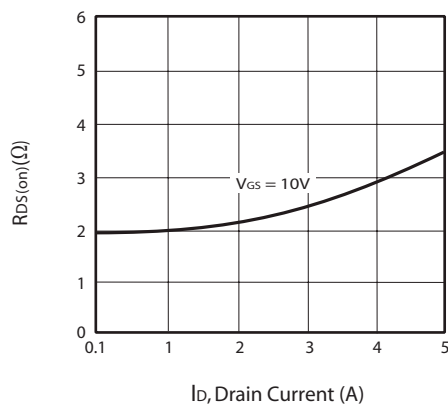

Figure 3. On-Resistance vs. Drain Current and Gate Voltage

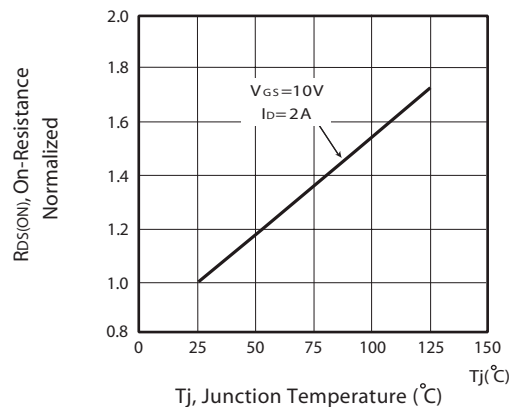

Figure 4. On-Resistance Variation with Drain Current and Temperature

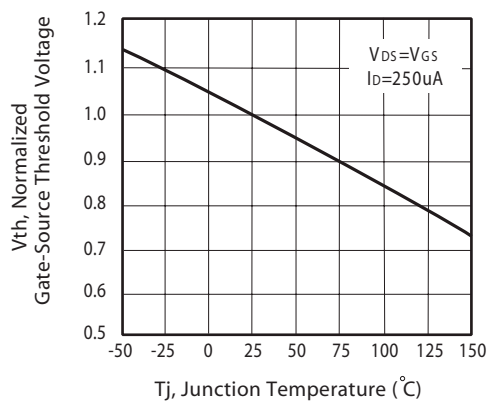

Figure 5. Gate Threshold Variation with Temperature

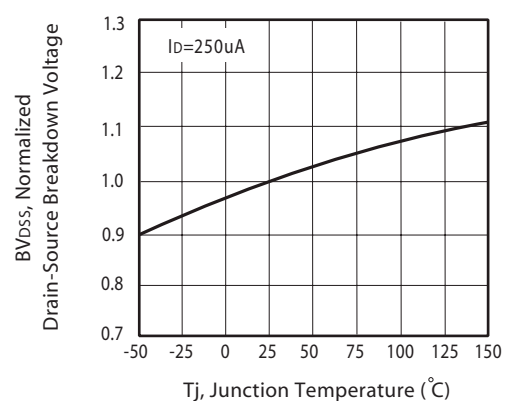

Figure 6. Breakdown Voltage Variation with Temperature

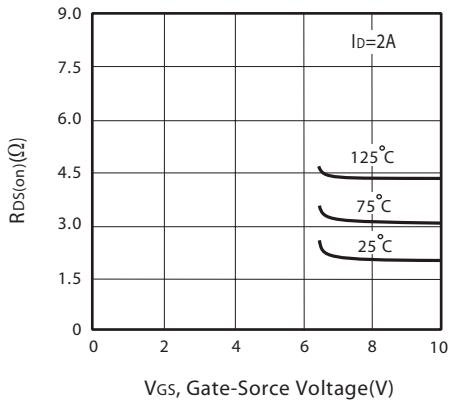

Figure 7. On-Resistance vs. Gate-Source Voltage

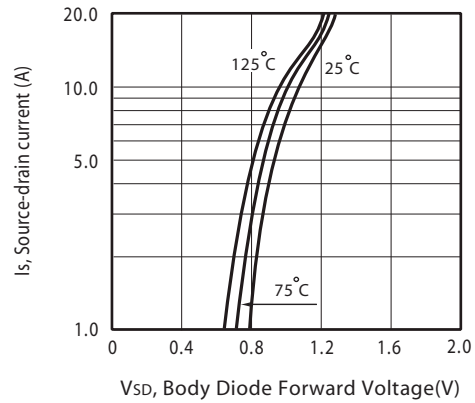

Figure 8. Body Diode Forward Voltage Variation with Source Current

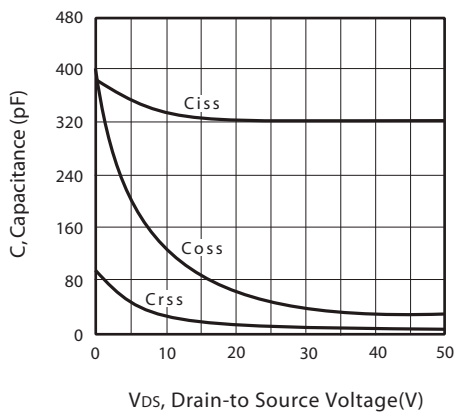

Figure 9. Capacitance

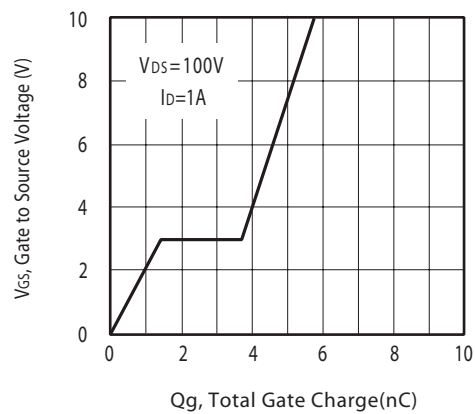

Figure 10. Gate Charge

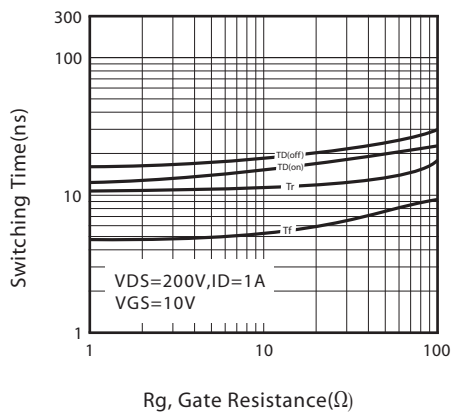

Figure 11. switching characteristics

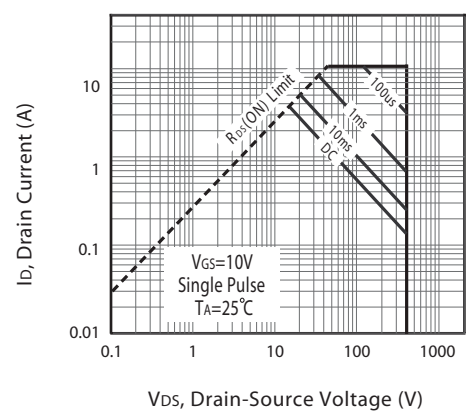
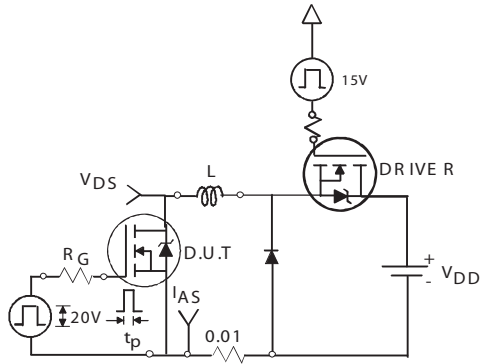
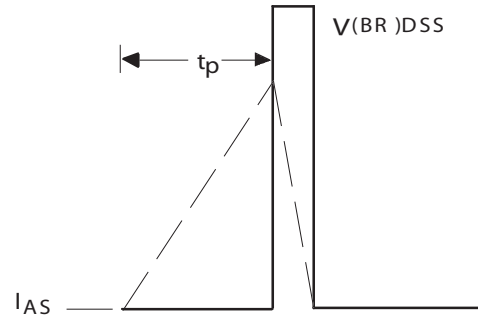

Figure 12. Maximum Safe Operating Area



Unclamped Inductive Test Circuit

Figure 13a.



Unclamped Inductive Waveforms

Figure 13b.

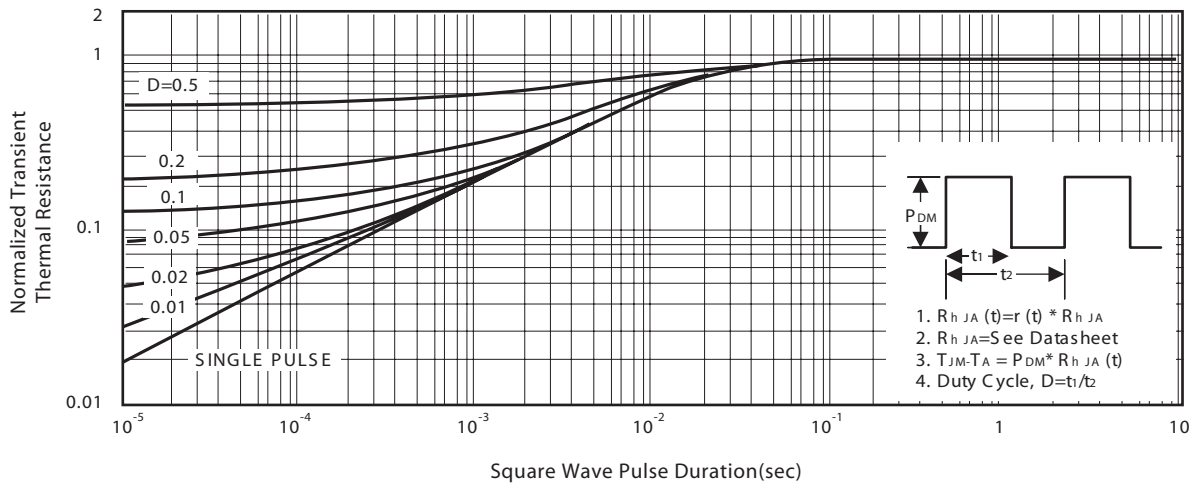
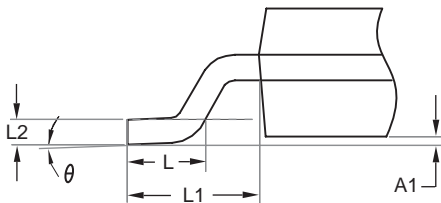
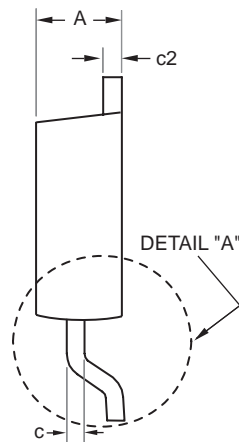
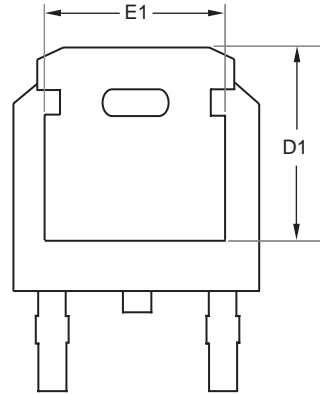
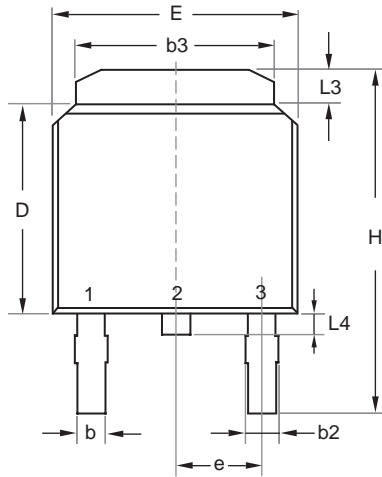

Figure 14. Normalized Thermal Transient Impedance Curve

SDU/D05N04

Ver 1.2

TO-252



DETAIL "A"

SYMBOLS	MILLIMETERS	
	MIN	MAX
A	2.200	2.380
A1	0.000	0.127
b	0.635	0.889
b2	0.762	1.143
b3	5.200	5.460
c	0.450	0.600
c2	0.450	0.580
D	6.000	6.223
D1	5.210	5.380
e	2.286 BSC	
E	6.400	6.731
E1	4.318	4.900
H	9.400	10.400
L	1.400	1.770
L1	2.743 REF	
L2	0.508 BSC	
L3	0.890	1.270
L4	0.640	1.010
θ	0°	10°

Dec,24,2013

PACKAGE OUTLINE DIMENSIONS

TO-251S

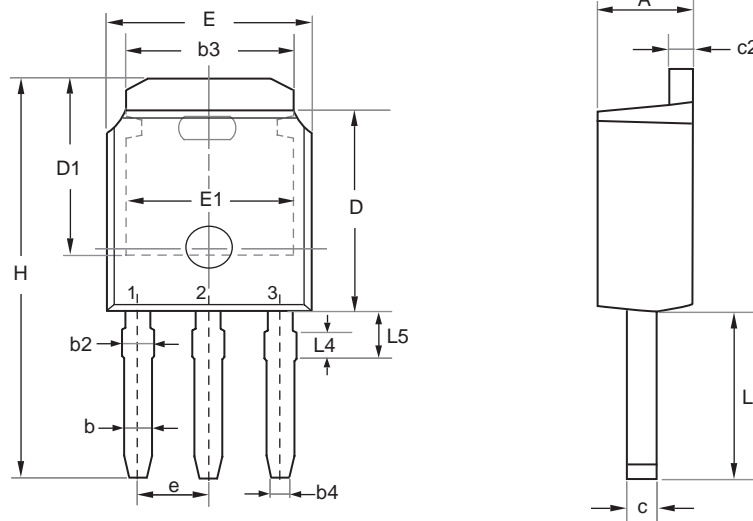

SYMBOL	MILLIMETERS	
	MIN	MAX
E	6.350	6.731
L	3.700	4.400
L4	0.698 REF	
L5	0.972	1.226
D	5.970	6.223
H	9.670	11.450
b	0.630	0.850
b2	0.760	1.140
b3	4.950	5.460
b4	0.450	0.550
e	2.286 BSC	
A	2.180	2.390
c	0.400	0.610
c2	0.400	0.610
D1	5.100	---
E1	4.318	---

PACKAGE OUTLINE DIMENSIONS

TO-251L

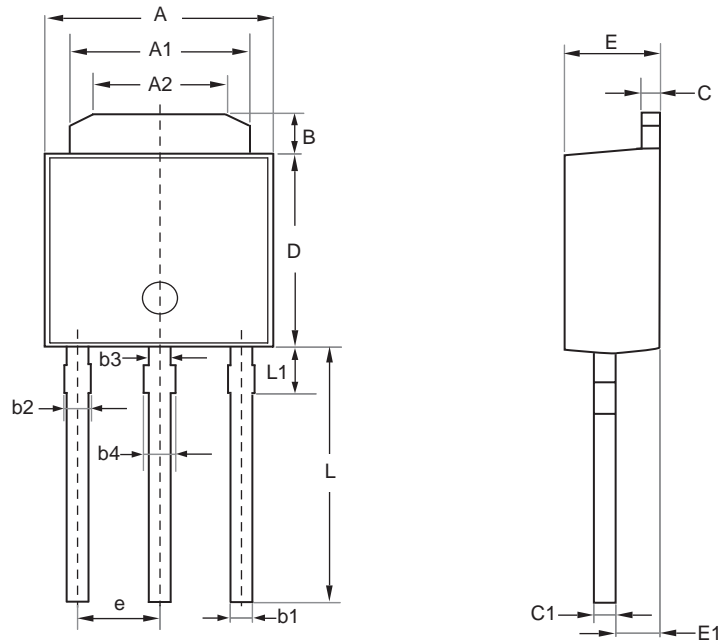

SYMBOL	MILLIMETERS		
	MIN	NOM	MAX
A	6.40	6.50	6.60
A1	5.30	5.40	5.50
A2	4.30	4.40	4.50
B	1.35	1.50	1.65
L1	1.55 REF		
L	7.40	7.70	8.00
D	5.40	5.55	5.70
C	0.55	0.60	0.65
C1	0.49	0.54	0.59
E1	1.72	1.77	1.82
E	2.20	2.30	2.40
b1	0.60	—	0.75
b2	0.70	—	0.85
b3	0.80		
b4	0.90		
e	2.30		

TO-251 Tube/TO-252 Tape and Reel Data

TO-251 Tube

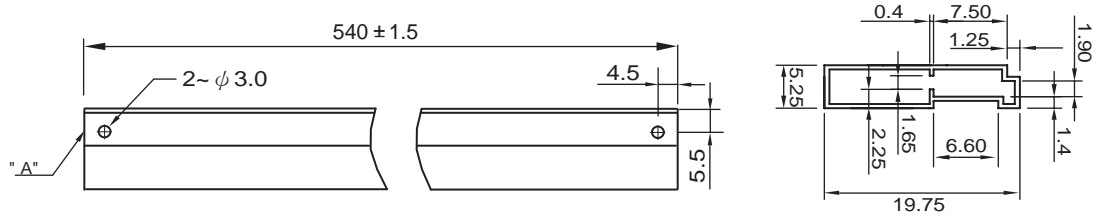

TO-252 Carrier Tape

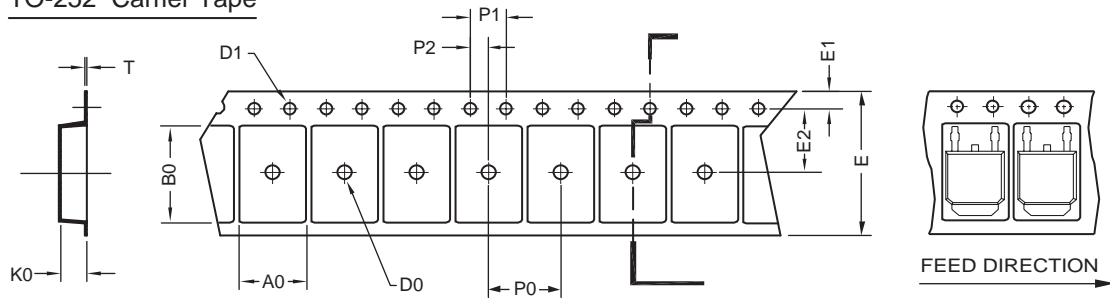

UNIT:mm

PACKAGE	A0	B0	K0	D0	D1	E	E1	E2	P0	P1	P2	T
TO-252 (16 mm)	6.96 ±0.1	10.49 ±0.1	2.79 ±0.1	φ 2	φ 1.5 +0.1 - 0	16.0 ±0.3	1.75 ±0.1	7.5 ±0.15	8.0 ±0.1	4.0 ±0.1	2.0 ±0.15	0.3 ±0.05

TO-252 Reel

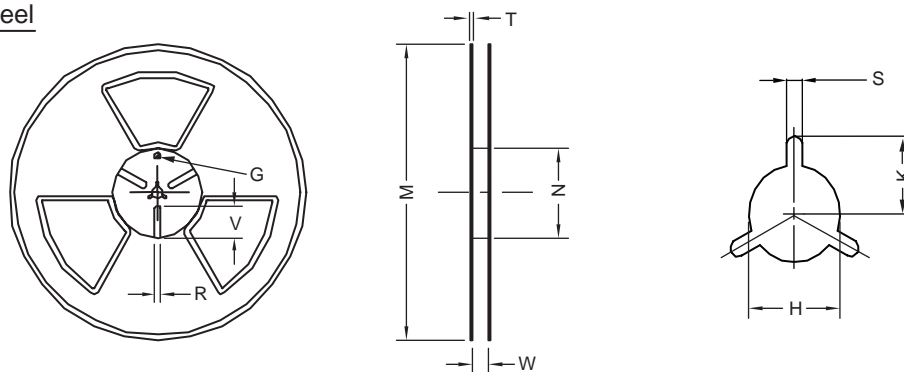

UNIT:mm

TAPE SIZE	REEL SIZE	M	N	W	T	H	K	S	G	R	V
16 mm	φ 330	φ 330 ± 0.5	φ 97 ± 1.0	17.0 + 1.5 - 0	2.2	φ 13.0 + 0.5 - 0.2	10.6	2.0 ±0.5	---	---	---

TOP MARKING DEFINITION

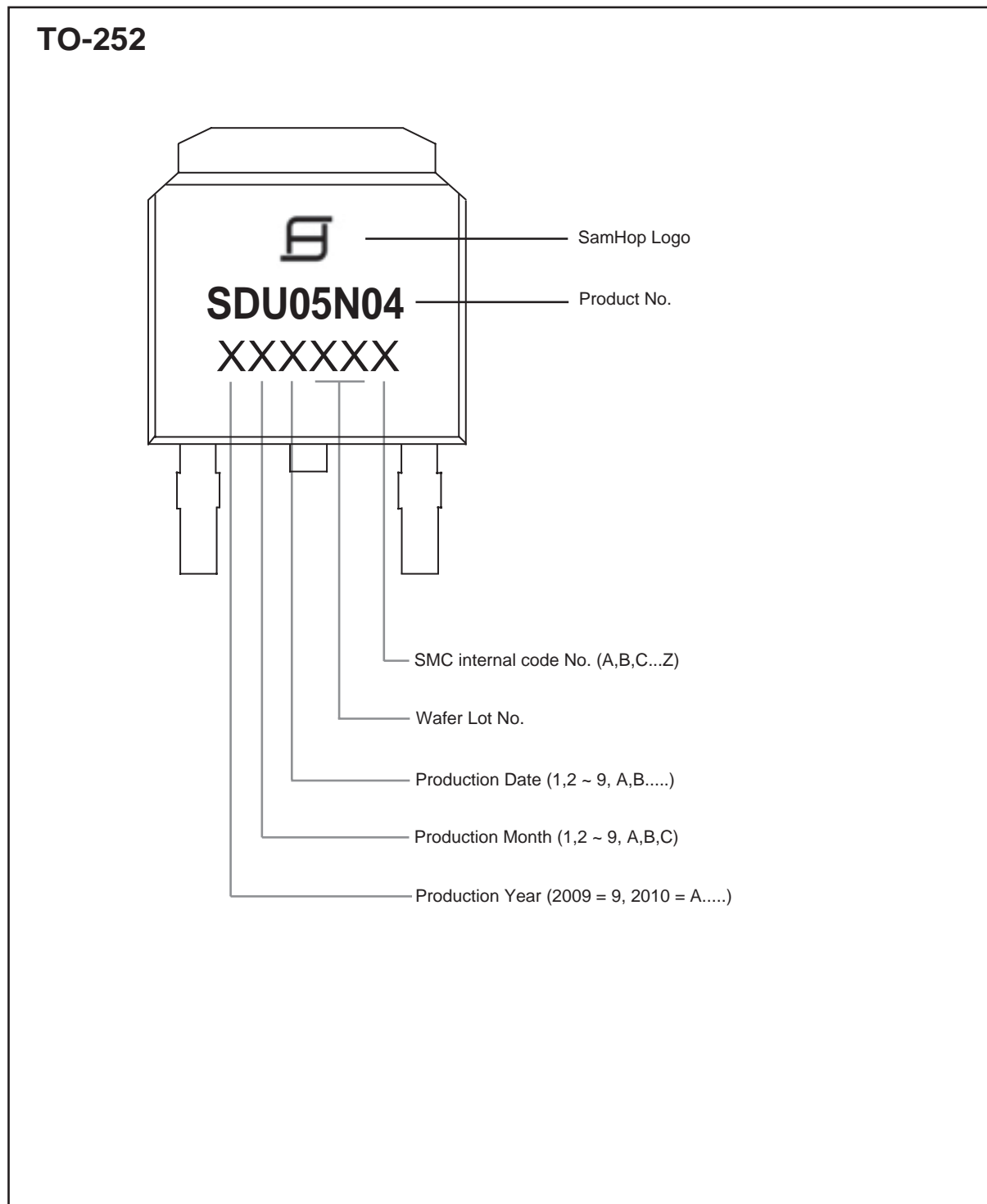

TOP MARKING DEFINITION

