



Using the SPIRIT1 transceiver under EN 300 220 at 868 MHz

By Placido De Vita

Introduction

The SPIRIT1 is a very low power RF transceiver, intended for RF wireless applications in the sub-1 GHz band. It is designed to operate both in the licence-free ISM and SRD frequency bands at 169, 315, 433, 868 and 915 MHz.

This application note outlines the expected performance when using the SPIRIT1 under EN 300 220-1 (v2.3.1, 2012-02) [2] in the 863 to 870 MHz band. This band is divided into sub-bands where the application, the maximum radiated power, the channel spacing and/or the mitigation requirement (duty cycle etc.) are different. The maximum allowed output power is +27 dBm (500 mW) in 869.4 to 869.65 MHz, and it is variable in the other sub-bands (see Table 5 in ETSI EN 300 220-1 v2.3.1 [2]). This application note relates to +10 dBm (10 mW) applications.

For details on the regulatory limits in the 863.000 - 870.000 MHz SRD frequency bands, please refer to the ETSI EN 300 220-1 v2.3.1 [2] and ERC recommendation 70-03 [3]. These can be downloaded from www.etsi.org and www.ero.dk respectively.

Contents

- 1 Application circuit 3**
- 2 Transmitter parameter 6**
 - 2.1 Adjacent channel power 6
 - 2.2 Modulation bandwidth 7
 - 2.3 Unwanted emissions in the spurious domain 9
- 3 Receiver parameters 11**
 - 3.1 Receiver sensitivity 11
 - 3.2 Blocking 12
 - 3.3 Receiver spurious radiation 13
- 4 Measurement equipment 15**
- 5 Reference 16**
- 6 Revision history 17**

1 Application circuit

Figure 1 shows an image of the SPIRIT1 application daughterboard. The application is made up of 2 boards: a daughterboard and a motherboard. The daughterboard includes the SPIRIT1 with all the required external components. For correct functioning, the daughterboard must be plugged into a motherboard (see *Figure 2*) through two header 5x2 connectors (J6 and J7).

The motherboard is provided with an STM32L152VBT6 micro to correctly program the transceiver. The micro is programmed with firmware developed for the SPIRIT1 application. A graphical user interface (GUI) has been developed to correctly program the SPIRIT1.

The daughterboard is provided with a 50 MHz Xtal to provide the correct oscillator to the SPIRIT. The W-MBUS S-mode, T-mode and R-mode applications, expressly used for the 868 MHz band, can be supported by the SPIRIT. A dedicated W-MBUS application (firmware) at 868 MHz has been developed. This document is for general purpose applications that work in the 863.000 - 870.000 MHz bandwidth.

The SPIRIT has an internal SMPS that drastically reduces power consumption, making the SPIRIT1 the best in class for applications on this bandwidth. The SMPS is fed from the battery (1.8 V to 3.6 V) and provides a programmable voltage (1.4 V typically) to the device. An SMA connector is present to connect the board at the antenna or at the instrumentation to verify the correct functionality and verify the ETSI standard request.

A few passive parts (inductors and capacitors) are used as matching/filtering for the power amplifier (PA) and balun network for the receiver.

To reduce application costs, the SPIRIT is designed to work without an external antenna switch. This daughterboard is designed to show the SPIRIT functions in this condition. An application with an antenna switch can certainly be realized, but is not described in this document.

Figure 1. SPIRIT1 application daughterboard

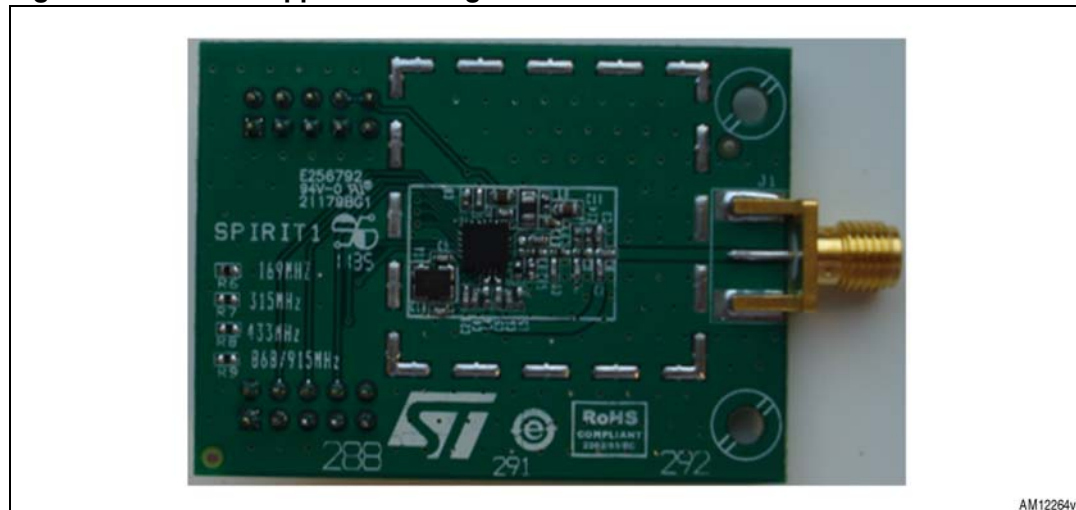

Figure 2. SPIRIT1 application daughterboard plugged into the motherboard

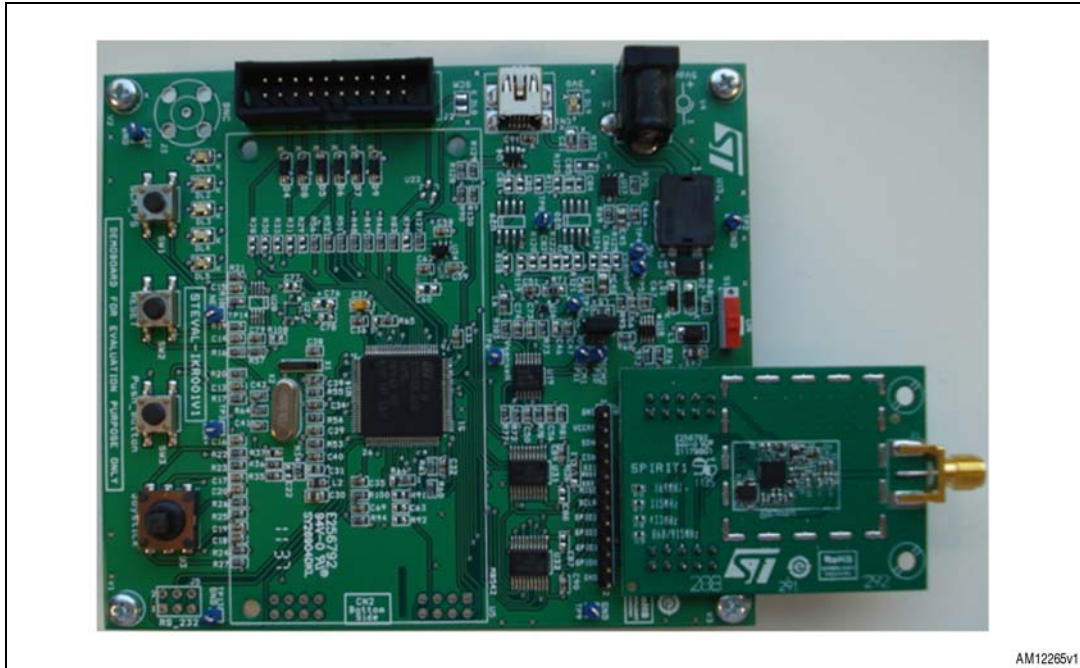
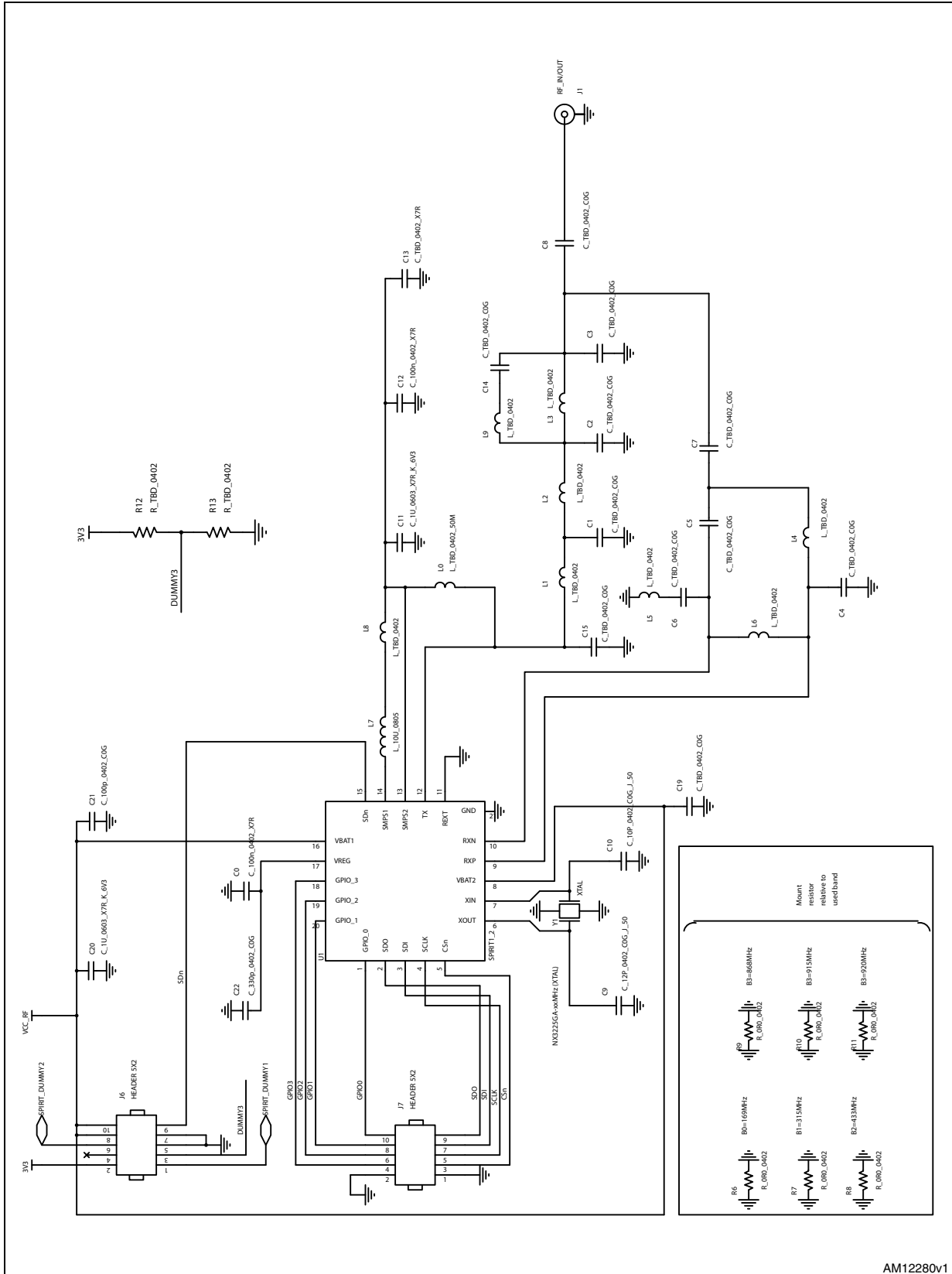

Figure 3 shows the daughterboard schematic.

Figure 3. Daughterboard schematic



2 Transmitter parameter

All the measurements here reported are performed with the following parameters: $T_c = 25\text{ }^\circ\text{C}$, $V_{dd} = 3.0\text{ V}$, $f = 868.300\text{ MHz}$.

The modulation bandwidth and adjacent channel power measurements are here reported. The measurements are realized according to EN 300 220 v1 [2] sections 7.6 and 7.7.

2.1 Adjacent channel power

The adjacent channel power (ACP) is defined as the amount of the modulated RF signal power which falls within a given adjacent channel. This power is the sum of the mean power produced by the modulation, hum and noise of the transmitter. This measurement is applicable only to narrowband systems.

This test measures the power transmitted in the adjacent channel during continuous modulation. The ACP is measured with a spectrum analyzer that conforms to the requirements given in the EN 300 220-1 v2.3.1 (2010-02) [2] annex C.

In this application note the ACP measured with 25 kHz channel spacing is investigated. For this measurement the integrated bandwidth of the adjacent channel is 16 kHz and the ETSI limit for the ACP is 200 nW (-37 dBm).

Figure 4 illustrates the measured ACP at the 868.3 MHz center frequency. The data rate is set to 9.6 kbps, the frequency deviation is set to 2.4 kHz, and the modulation is set to gaussian FSK (GFSK) with a $BT = 1$.

The output power integrated around the carrier is 11 dBm in a 16 kHz bandwidth and with average detection. With this power the ACP is -39 dBm, that is 2 dB better than the ETSI limit.

In *Figure 4* the alternate channel power (ALT) is also reported. With this power the ALT is -46 dBm. Regarding the ALT, no specification is defined in the ETSI standard.

The SPIRIT1 is fully compliant with the ETSI transmitter adjacent channel power requirements with margin.

Figure 4. Adjacent power measurement, 25 kHz narrowband channel spacing, 9.6 kbps data rate, 2.4 kHz frequency deviation

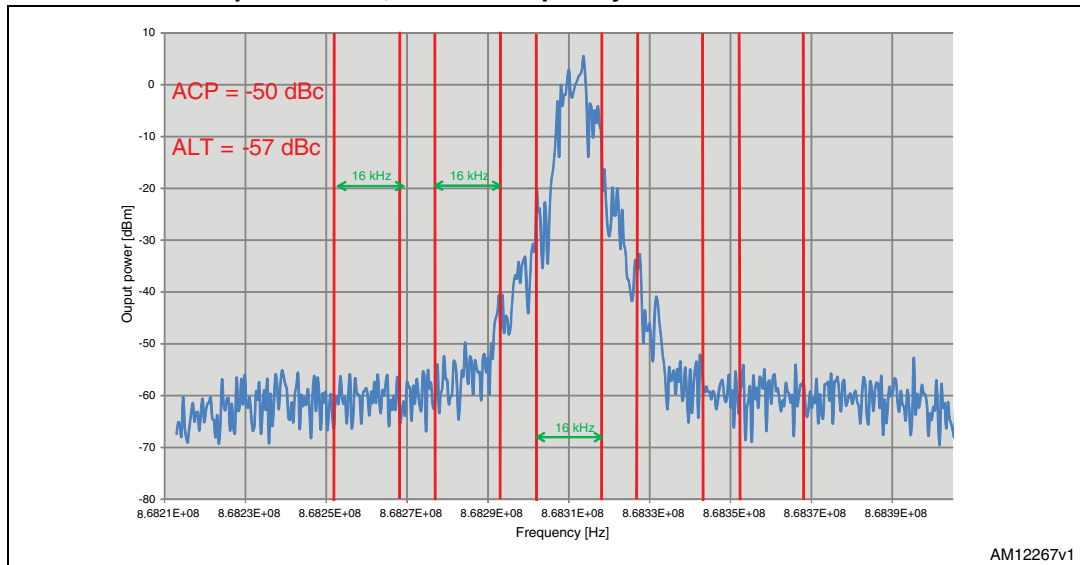

2.2 Modulation bandwidth

The range of the modulation bandwidth includes all associated side bands above the appropriate emissions level and the frequency error or drift under extreme test conditions. The frequency drift in extreme test conditions primarily depends on the crystal quality, which is not included in this report.

[Figure 5](#) illustrates the ETSI spectral mask with which the radio must comply at the sub-band edges. Basically, there are only two limit thresholds, what changes is the bandwidth of integration at the different offset regions.

The same spectral masks are reported in [Figure 6](#) and [7](#) as well. The device center frequency is 868.3 MHz, the data rate is set to 9.6 kbps, the frequency deviation is set to 2.4 kHz, and the modulation is set to gaussian FSK (GFSK) with a BT = 1, in [Figure 6](#), 38.4 kbps as data rate, 20 kHz as frequency deviation and gaussian FSK (GFSK) with a BT = 1 as modulation, in [Figure 7](#). The applied output power is set to 11 dBm. With these parameters, the spectral masks of the SPIRIT1 comply with ETSI [2] subclause 7.7.

Figure 5. ETSI spectral mask measurement limits and sub-band edges

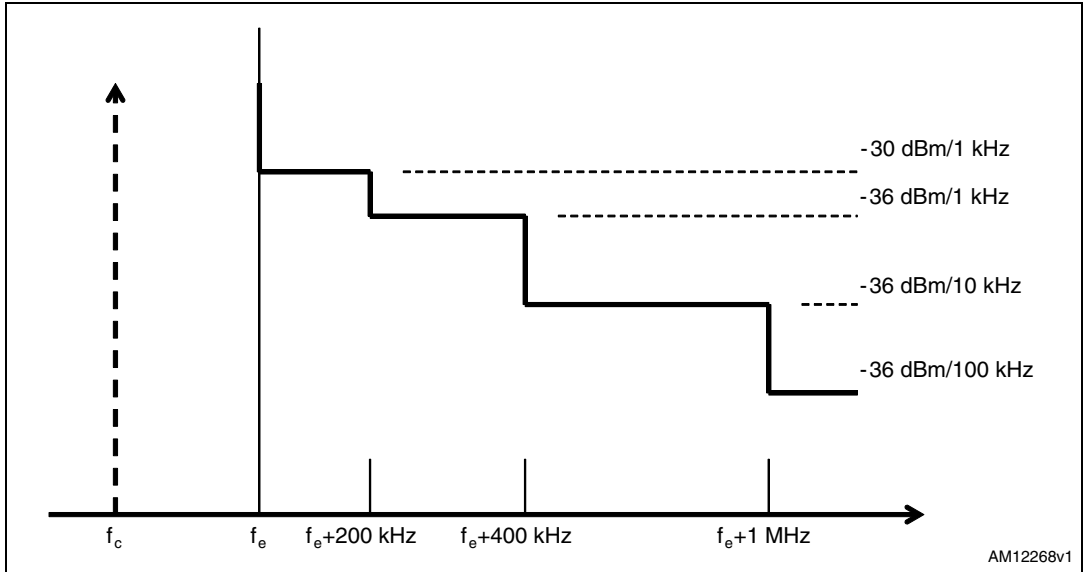

Note: f_c is the emission center frequency.
 f_e is the sub-band edge frequency.
 Only the upper half of the emission is shown. The lower half is a mirror image.

Figure 6. Spectral mask measurement, 25 kHz narrowband channel spacing, 9.6 kbps data rate, 2.4 kHz frequency deviation

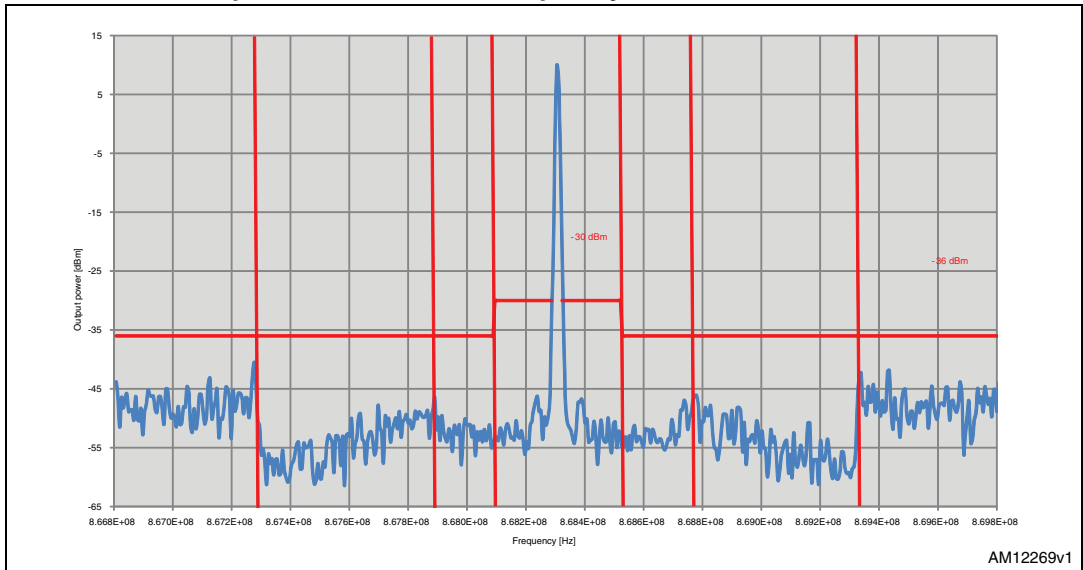
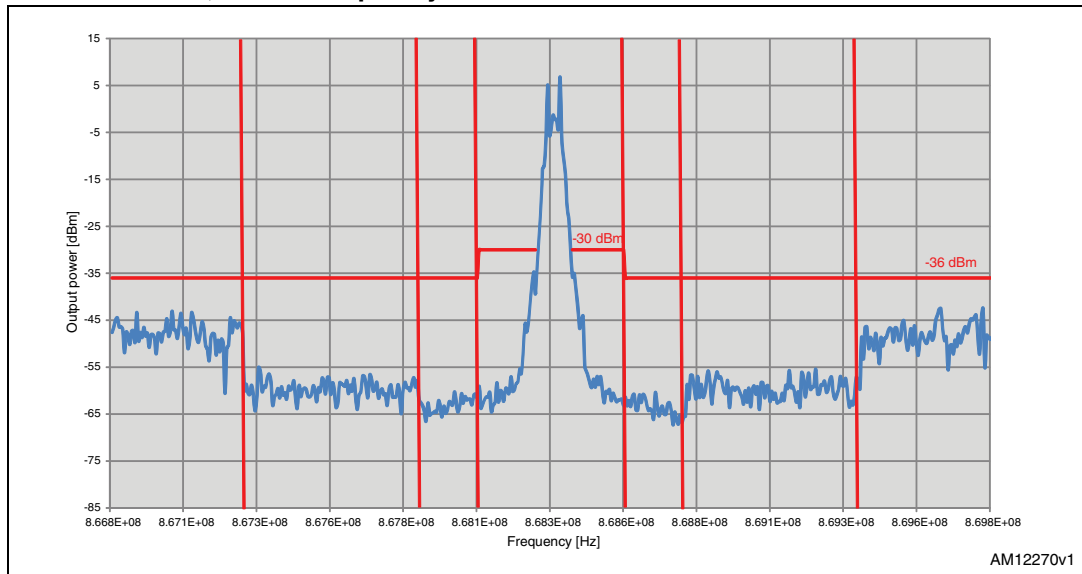

Figure 7. Spectral mask measurement, 100 kHz channel spacing, 38.4 kbps data rate, 20 kHz frequency deviation



2.3 Unwanted emissions in the spurious domain

Spurious emissions are unwanted emissions in the spurious domain at frequencies other than those of the wanted carrier frequency and its sidebands associated with normal test modulation.

A spectrum analyzer is used as external receiver. The measurement is performed setting the SPIRIT1 with modulation and checking unwanted spurious emissions up to 6 GHz as described in the ETSI [2] subclause 7.8.

The measurement is split into two figures. In [Figure 8](#) the unwanted spurious emission for a frequency below 1 GHz is shown. The measurement is performed setting the instrument with a resolution bandwidth of 100 kHz, as requested in ETSI [2]. In [Figure 9](#) the unwanted spurious emission for a frequency from 1 GHz to 6 GHz is shown. The measurement is performed setting the instrument with a resolution bandwidth of 1 MHz, as requested in ETSI [2]. In the two images the mask request from the ETSI is reported also.

The unwanted emissions in the spurious domain of SPIRIT1 comply with ETSI [2] subclause 7.8.

Figure 8. Unwanted spurious emission below 1 GHz

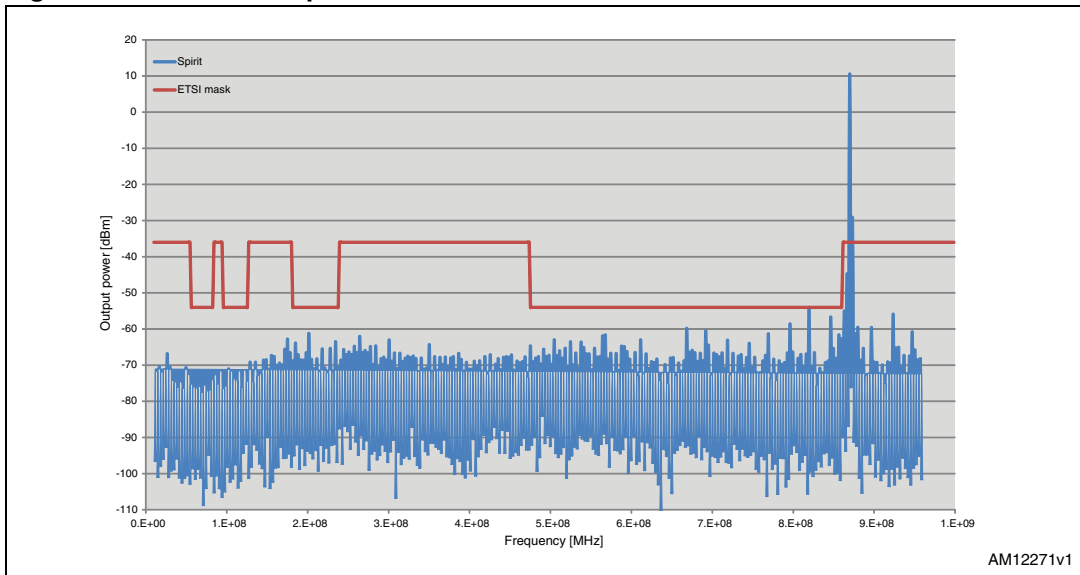
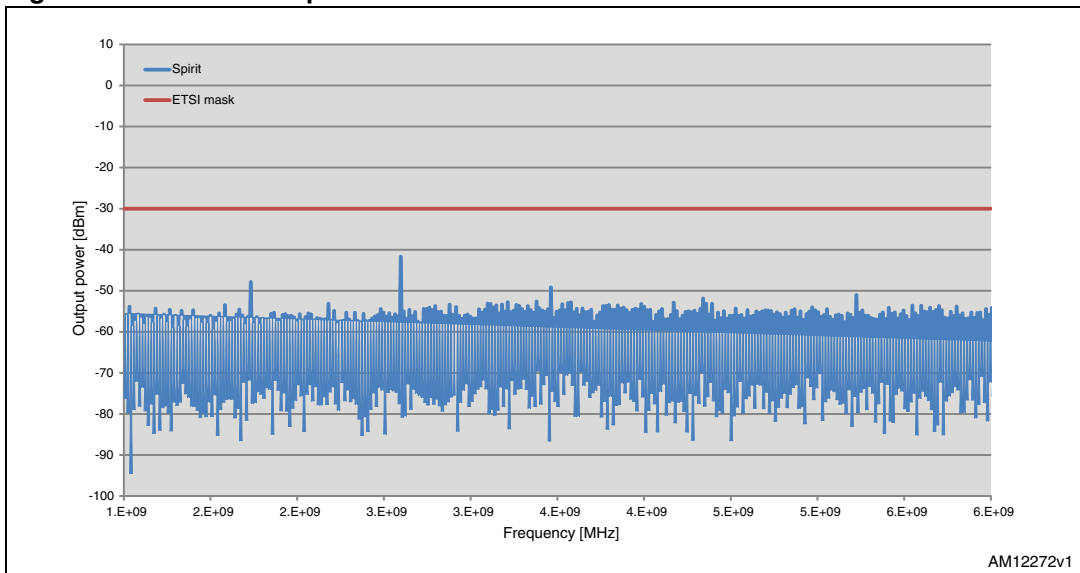

Figure 9. Unwanted spurious emission over 1 GHz



3 Receiver parameters

All the measurements here reported are performed with the following parameters: $T_c = 25\text{ }^\circ\text{C}$, $V_{dd} = 3.0\text{ V}$, $f = 868.300\text{ MHz}$.

The product family of short range radio devices is divided into three receiver categories, each having a set of relevant receiver requirements and minimum performance criteria. The set of receiver requirements depends on the choice of receiver category by the equipment provider. The SPIRIT1 is a transceiver that meets receiver category 2. According to EN 300 220-1 (v2.3.1, 2012-02) [2], a category 2 receiver is described as “Medium reliable SRD communication media, e.g. causing inconvenience to persons, which cannot simply be overcome by other means”.

The main parameters that must be measured for category 2 devices are the sensitivity and the blocking. The adjacent channel selectivity refers to receiver category 1, and so it is not necessary for SPIRIT1 to meet this parameter.

3.1 Receiver sensitivity

The receiver sensitivity is the minimum level of the signal at the receiver input, produced by a carrier at the nominal frequency of the receiver, modulated with the normal test signal modulation, which produces the performance of a bit error rate (BER) of 10⁻² without correction.

Under normal test conditions, the value of the typical usable sensitivity for 25 kHz channel spacing equipment with a 16 kHz bandwidth should not exceed -107 dBm. If the RX bandwidth is not 16 kHz, the sensitivity limit is modified according to the following formula:

Equation 1

$$Sp[\text{dBm}] = 10\log\left(\frac{BW[\text{kHz}]}{16}\right) - 107$$

The measurement is performed using an RF signal source generator centered at the same receiver frequency with the wanted modulation signal. The demodulated data and clock are taken from the SPIRIT1 receiver and sent to the same generator to perform the BER measurement. The generator signal level is reduced and then a BER of 1% is obtained.

To reduce the power consumption, an internal SMPS is integrated into the SPIRIT1. [Figure 10](#) demonstrates the ETSI 1% BER sensitivity limit (red line) and the SPIRIT1 sensitivity for different data rate with internal and external SMPS. This application note outlines the expected performance when using the SPIRIT1 under EN 300 220-1 (v2.3.1, 2012-02) [2] in the 863.000 - 870.000 MHz band, without defining the maximum channel spacing. In order to show the real performance of the SPIRIT1 transceiver, different channel spacings are shown. The test conditions are: 2-FSK modulation with 1 kHz frequency deviation and 6 kHz channel bandwidth for the 1.2 kbps data rate, 2-FSK modulation with 20 kHz frequency deviation and 100 kHz channel bandwidth for the 38.4 kbps data rate, GFSK (BT = 1) modulation with 127 kHz frequency deviation and 540 kHz channel bandwidth for the 250 kbps data rate and MSK modulation with 812 kHz channel bandwidth for the 500 kbps data rate.

The SPIRIT1 is fully compliant with the ETSI category 2 receiver sensitivity requirements with large margin.

Figure 10. Sensitivity vs. data rate with 1% BER

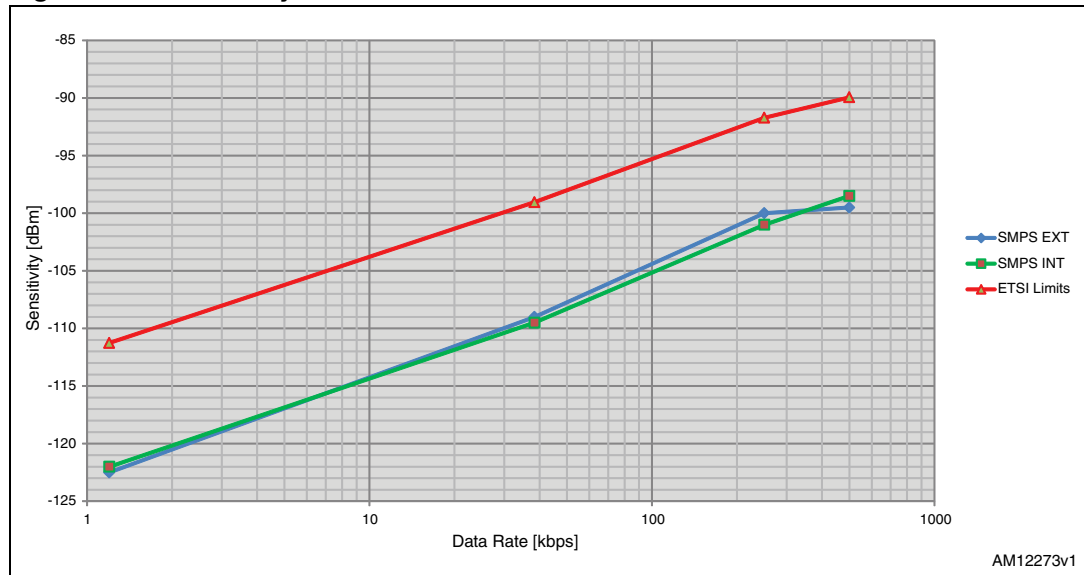

3.2 Blocking

Blocking is a measurement of the capability of the receiver to receive a wanted modulated signal without exceeding a given degradation due to the presence of an unwanted input signal at any frequency other than those of the spurious responses or the adjacent channels or bands.

All the blocking results are measured by positioning the input power 3 dB above the measured sensitivity limit reported in the previous paragraph with a primary signal source generator. A second generator with an unmodulated signal is used as the interferer and combined with the primary signal using a power combiner. The second interferer generator is placed at the desired frequency offset and the power is increased until the BER degradation of 1% is obtained.

ETSI specifies the blocking limits in absolute values at two points: ± 2 and ± 10 MHz. The limit for the category 2 receiver at ± 2 MHz is ± 35 dB - $10\log(BW_{\text{kHz}}/16 \text{ kHz})$, at ± 10 MHz it is ± 60 dB - $10\log(BW_{\text{kHz}}/16 \text{ kHz})$. [Figure 11](#) shows the blocking curve with 1.2 kbps data rate; [Figure 12](#) shows the blocking curve with 500 kbps data rate.

The SPIRIT1 is fully compliant with the ETSI category 2 receiver blocking requirements with large margin.

The adjacent channel selectivity is also defined in the ETSI EN300 220 [2] standard, a measurement of the capability of the receiver to operate satisfactorily in the presence of an unwanted signal, which differs in frequency from the wanted signal by an amount equal to the adjacent channel separation for which the equipment is intended. This parameter must be evaluated only for the device that complies with the ETSI category 1, so the SPIRIT1 does not have to be under this regulation.

Figure 11. RX blocking vs. CW interferer offset with 1% BER, 1.2 kbps data rate

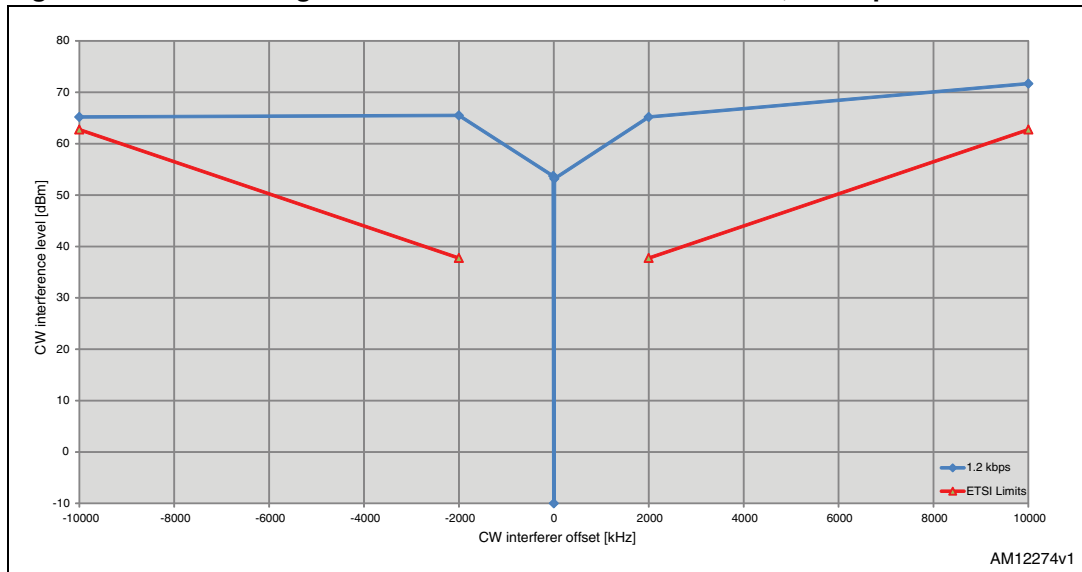
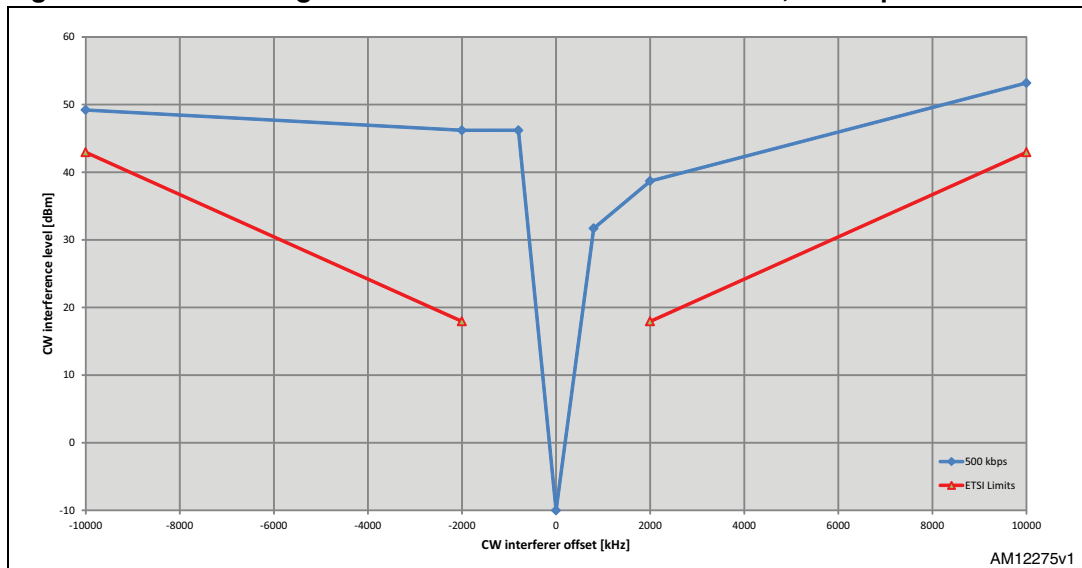

Figure 12. RX blocking vs. CW interferer offset with 1% BER, 500 kbps data rate



3.3 Receiver spurious radiation

Spurious radiations from the receiver are components at any frequency, radiated by the equipment and antenna.

A spectrum analyzer is used as external receiver. The measurement is performed setting the SPIRIT1 with modulation and checking receiver spurious emissions up to 6 GHz as described in the ETSI [2] subclause 8.6.

The measurement is split into two figures. In [Figure 13](#) the unwanted spurious emission for frequency below 1 GHz is shown. The measurement is performed setting the instrument with a resolution bandwidth of 100 kHz, as requested in the ETSI [2]. In [Figure 14](#) the spurious radiations from the receiver for a frequency from 1 GHz to 6 GHz is shown. The

measurement is performed setting the instrument with a resolution bandwidth of 1 MHz, as requested in ETSI [2]. In the two images the mask request from the ETSI is reported also.

The receiver spurious radiation of SPIRIT1 complies with ETSI [2] subclause 8.6.

Figure 13. Receiver spurious emission below 1 GHz

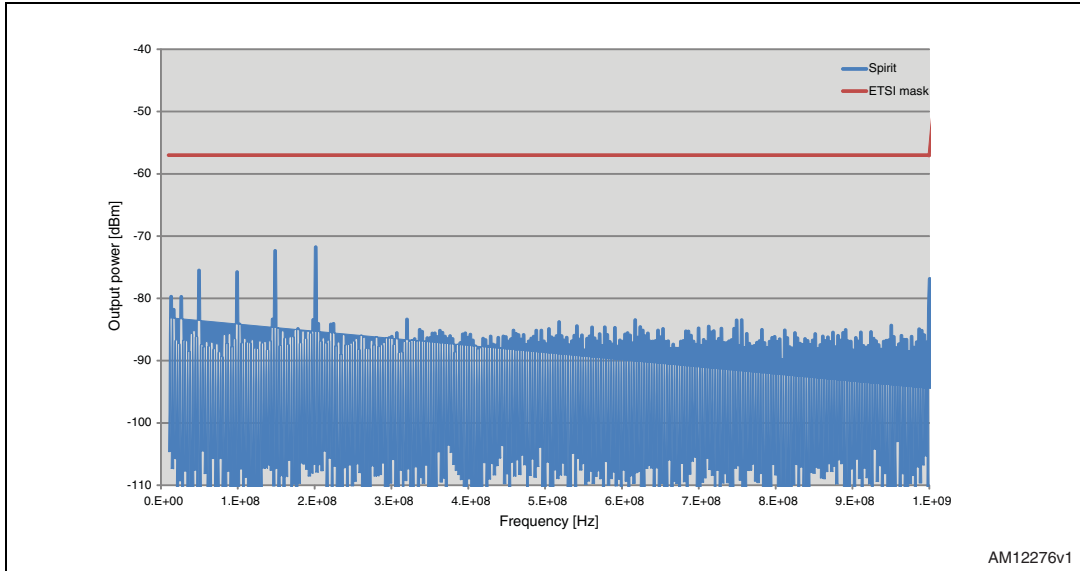
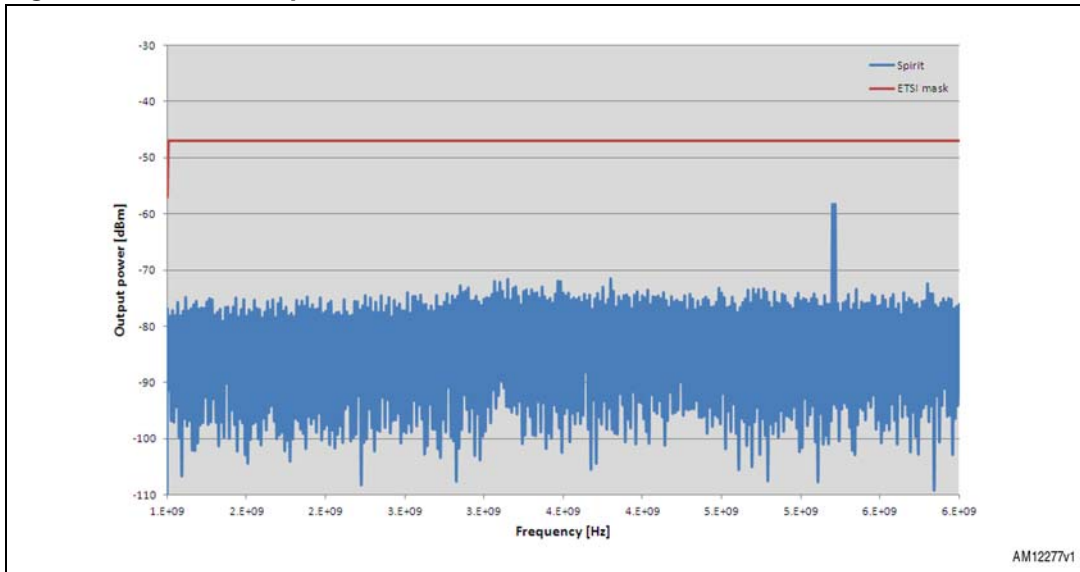

Figure 14. Receiver spurious emission over 1 GHz



4 Measurement equipment

The following equipment was used for the measurements.

Table 1. Measurement equipment

| Measurement | Instrument type | Instrument model |
|-------------|------------------|--|
| RX | Signal generator | Agilent ESG E4438C Agilent ESG E4438C |
| TX | Signal analyzer | R&S FSIQ7 |

5 Reference

1. SPIRIT1 datasheet.
2. ETSI EN300 220 V2.3.1: "Electromagnetic compatibility and Radio spectrum Matters (ERM); Short Range Devices (SRD); Radio equipment to be used in the 25 MHz to 1000 MHz frequency range with power levels ranging up to 500 mW".
3. CEPT/ERC/Recommendation 70-03: "Relating to the use of short range devices (SRD)".
4. CEN/TC prEN 13757-4:2011.10: "Communication systems for meters and remote reading of meters - Part 4: Wireless meter readout (radio meter reading for operating in SRD bands)".

6 Revision history

Table 2. Document revision history

| Date | Revision | Changes |
|-------------|----------|------------------|
| 11-Jul-2012 | 1 | Initial release. |

Please Read Carefully:

Information in this document is provided solely in connection with ST products. STMicroelectronics NV and its subsidiaries ("ST") reserve the right to make changes, corrections, modifications or improvements, to this document, and the products and services described herein at any time, without notice.

All ST products are sold pursuant to ST's terms and conditions of sale.

Purchasers are solely responsible for the choice, selection and use of the ST products and services described herein, and ST assumes no liability whatsoever relating to the choice, selection or use of the ST products and services described herein.

No license, express or implied, by estoppel or otherwise, to any intellectual property rights is granted under this document. If any part of this document refers to any third party products or services it shall not be deemed a license grant by ST for the use of such third party products or services, or any intellectual property contained therein or considered as a warranty covering the use in any manner whatsoever of such third party products or services or any intellectual property contained therein.

UNLESS OTHERWISE SET FORTH IN ST'S TERMS AND CONDITIONS OF SALE ST DISCLAIMS ANY EXPRESS OR IMPLIED WARRANTY WITH RESPECT TO THE USE AND/OR SALE OF ST PRODUCTS INCLUDING WITHOUT LIMITATION IMPLIED WARRANTIES OF MERCHANTABILITY, FITNESS FOR A PARTICULAR PURPOSE (AND THEIR EQUIVALENTS UNDER THE LAWS OF ANY JURISDICTION), OR INFRINGEMENT OF ANY PATENT, COPYRIGHT OR OTHER INTELLECTUAL PROPERTY RIGHT.

UNLESS EXPRESSLY APPROVED IN WRITING BY TWO AUTHORIZED ST REPRESENTATIVES, ST PRODUCTS ARE NOT RECOMMENDED, AUTHORIZED OR WARRANTED FOR USE IN MILITARY, AIR CRAFT, SPACE, LIFE SAVING, OR LIFE SUSTAINING APPLICATIONS, NOR IN PRODUCTS OR SYSTEMS WHERE FAILURE OR MALFUNCTION MAY RESULT IN PERSONAL INJURY, DEATH, OR SEVERE PROPERTY OR ENVIRONMENTAL DAMAGE. ST PRODUCTS WHICH ARE NOT SPECIFIED AS "AUTOMOTIVE GRADE" MAY ONLY BE USED IN AUTOMOTIVE APPLICATIONS AT USER'S OWN RISK.

Resale of ST products with provisions different from the statements and/or technical features set forth in this document shall immediately void any warranty granted by ST for the ST product or service described herein and shall not create or extend in any manner whatsoever, any liability of ST.

ST and the ST logo are trademarks or registered trademarks of ST in various countries.

Information in this document supersedes and replaces all information previously supplied.

The ST logo is a registered trademark of STMicroelectronics. All other names are the property of their respective owners.

© 2012 STMicroelectronics - All rights reserved

STMicroelectronics group of companies

Australia - Belgium - Brazil - Canada - China - Czech Republic - Finland - France - Germany - Hong Kong - India - Israel - Italy - Japan - Malaysia - Malta - Morocco - Philippines - Singapore - Spain - Sweden - Switzerland - United Kingdom - United States of America

www.st.com