



QL65F6S-A/B/C

◆ OVERVIEW

QL65F6S-A/B/C is a MOCVD grown 650nm band *InGaAlP* laser diode with quantum well structure. It's an attractive light source, with a typical light output power of 10mW and low operating current for optoelectronic devices such as Optical Pick-up & Bar Code Reader.

◆ APPLICATION

- Optical Pick-up
- Laser Module
- Bar Code Reader

◆ FEATURES

- Visible Light Output : $\lambda_p = 650 \text{ nm}$
- Optical Power Output : 10mW CW
- Package Type : TO-18 (5.6mm ϕ)
- Built-in Photo Diode for Monitoring Laser Diode

◆ ELECTRICAL CONNECTION

Bottom View

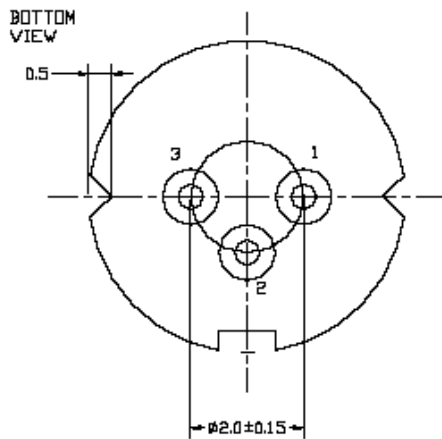

Pin Configuration

| | |
|---|-------------------------------|
| A | LD cathode, PD anode (Fig. 1) |
| B | LD, PD anode (Fig. 2) |
| C | LD anode, PD cathode (Fig. 3) |

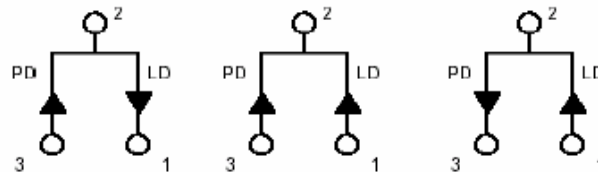

Fig. 1

QL65F6SA

Fig. 2

QL65F6SB

Fig. 3

QL65F6SC



◆ ABSOLUTE MAXIMUM RATING at Tc=25°C

| Items | Symbols | Values | Unit |
|-----------------------------|---------|-----------|------|
| Optical Output Power | P | 12 | mW |
| Laser Diode Reverse Voltage | V | 2 | V |
| Photo Diode Reverse Voltage | V | 30 | V |
| Operating Temperature | Topr | -10 ~ +60 | °C |
| Storage Temperature | Tstg | -40 ~ +85 | °C |

◆ ELECTRICAL and OPTICAL CHARACTERISTICS at Tc=25°C

| Items | Symbols | Min. | Typ. | Max. | Unit | Condition |
|----------------------|--------------------------------|------|------|-----------|---------------|-----------|
| Optical Output Power | Po | - | 10 | - | mW | - |
| Threshold Current | Ith | - | 40 | 50 | mA | - |
| Operating Current | Iop | - | 60 | 80 | mA | Po=10mW |
| Operating Voltage | Vop | - | 2.3 | 2.6 | V | Po=10mW |
| Lasing Wavelength | λ_p | 645 | 655 | 660 | nm | Po=10mW |
| Beam Divergence | $\theta_{ }$ | 6 | 9 | 12 | deg | Po=10mW |
| | θ_{\perp} | 24 | 28 | 35 | deg | Po=10mW |
| Beam Angle | $\Delta\theta_{ }$ | - | - | ± 1.5 | deg | Po=10mW |
| | $\Delta\theta_{\perp}$ | - | - | ± 2.5 | deg | Po=10mW |
| Monitor Current | I _m | 0.1 | 0.2 | 0.5 | mA | Po=10mW |
| Optical Distance | $\Delta X, \Delta Y, \Delta Z$ | - | - | ± 60 | μm | - |

NOTICE : QL65F6S-A/B/C to be operated on APC

The above product specifications are subject to change without notice.



◆ EXAMPLE of REPRESENTATIVE CHARACTERISTICS

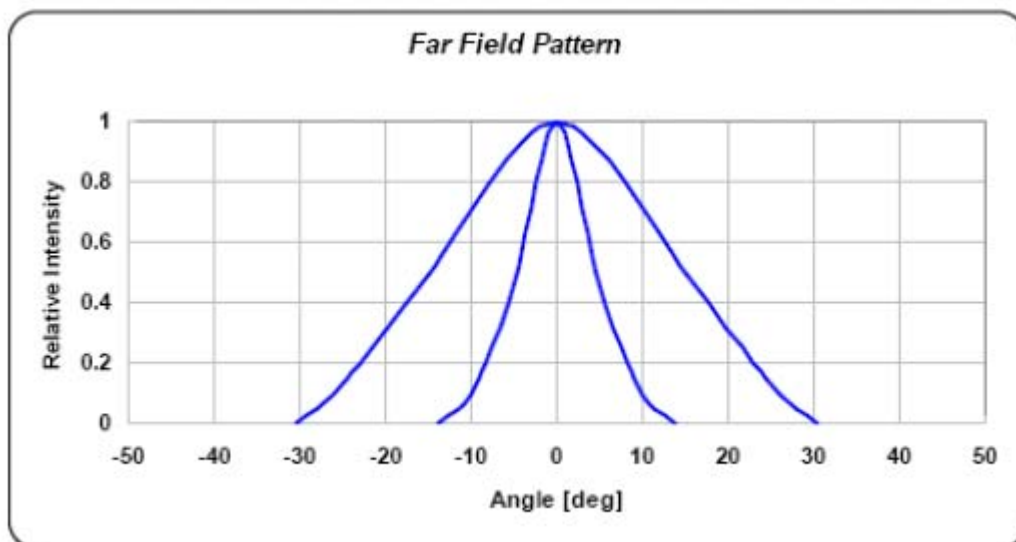
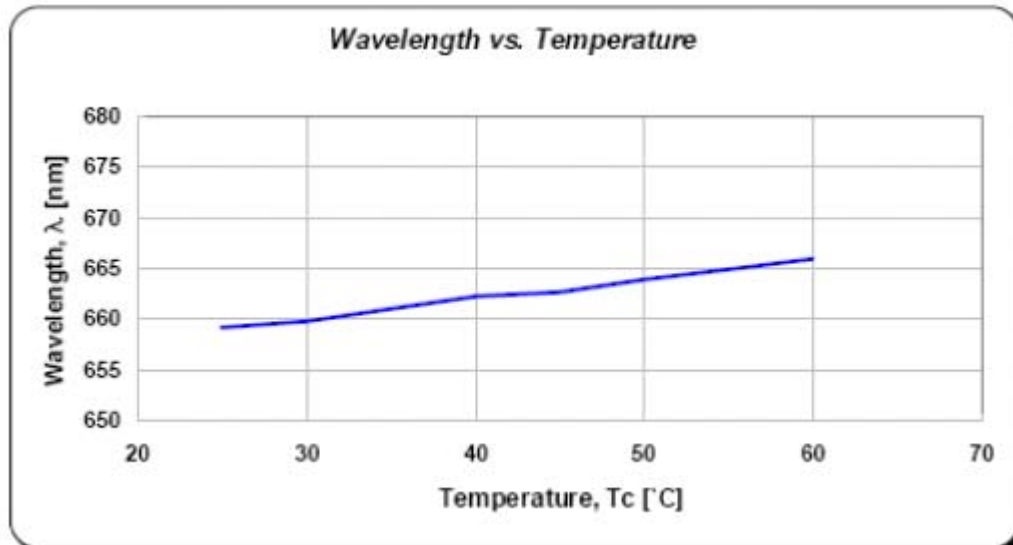
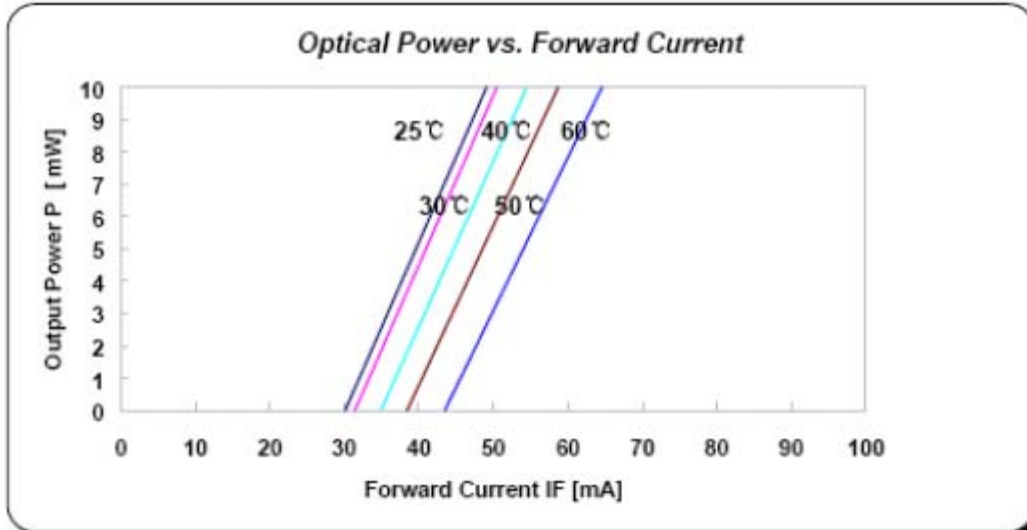

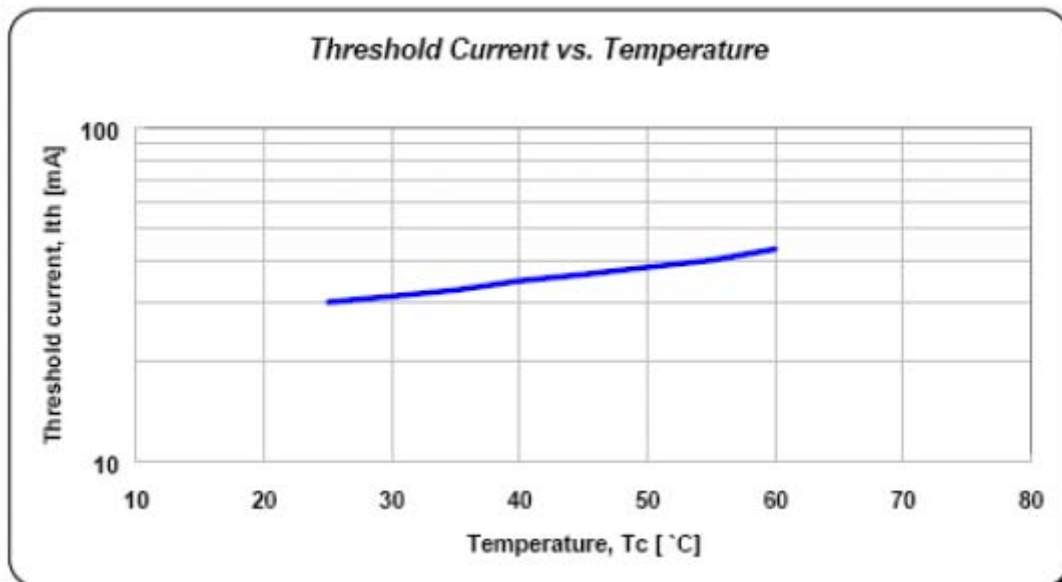
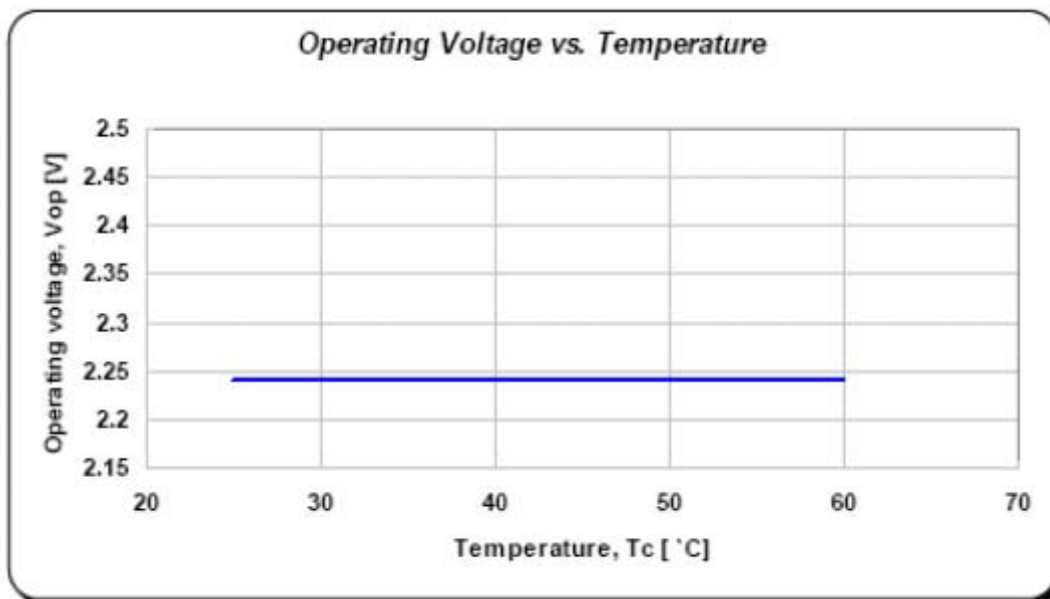
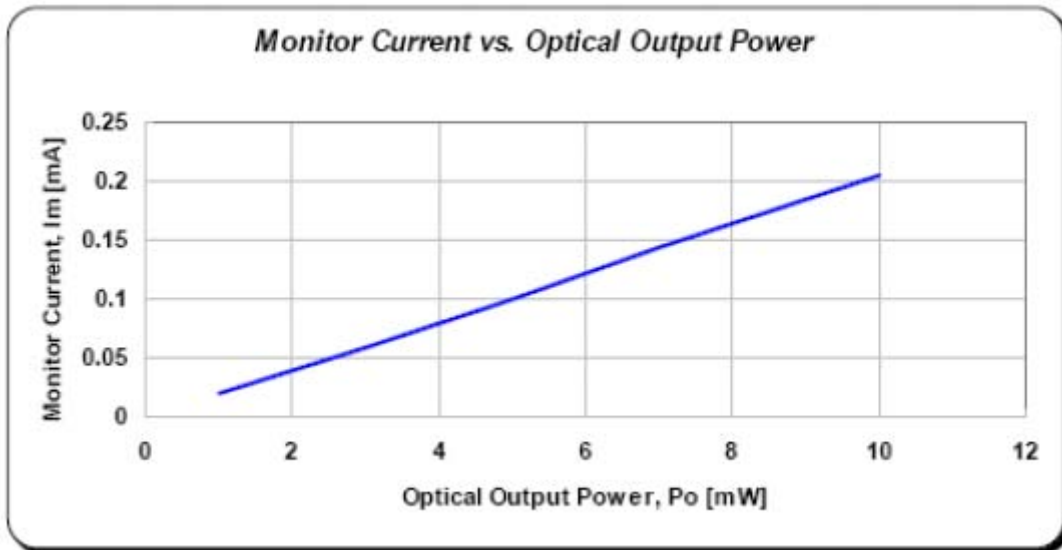



◆ PACKAGE DIMENSION

