

2.5 Volt Precision Reference

FEATURES

- Low drift 25ppm/°C Typ.
- Low output impedance 0.6 Ω Max.
- Operating current 400 μ A to 10mA
- Very low output tolerance \pm 1%
- Two terminal "Zener" operation
- Direct replacement for LM336, LM136/236, & MC1400
- Low cost

APPLICATIONS

- 8 Bit A/D and D/A Reference
- Reference for 5V Systems
- Digital Voltmeter
- Power Supply Monitor
- Current Loop Measurement and Control System

GENERAL DESCRIPTION

The ALPHA Semiconductor AS336 is a 3-terminal band-gap precision voltage reference which provides a stable fixed output voltage of 2.5V with a tolerance less than \pm 25mV. ALPHA Semiconductor's design, process, and precise on chip trimming enable us to achieve a low temperature coefficient as low as 25ppm/°C and \pm 1% reference tolerance. The AS336 is provided with a third terminal to allow the reference voltage to be adjusted to \pm 5%.

In many applications, the AS336 can be used as a pin-to-pin replacement for the LM136/236/336. The AS336 is available in TO-46, TO-92 and SO-8 packages at an operating temperature range of -25°C to 85°C and -55°C to 125°C.

ORDERING INFORMATION

| PART NUMBER | MAX TEMPCO ¹ ppm/°C | PACKAGE TYPE | TEMP. RANGE |
|-------------|-----------------------------------|--------------|-------------|
| AS336AT | 50 | TO-46 | MIL. |
| AS336BT | 50 | TO-46 | IND. |
| AS336AN/BN | 50 | TO-92 | IND. |
| AS336AS/BS | 50 | SO-8 | IND. |

1. For lower Tempco, consult factory

Pin Connections

8-Pin Surface Mount

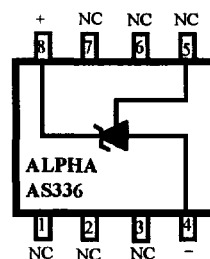

Top View

TO-46 Metal Can Package

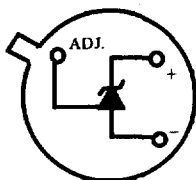

Bottom View

TO-92 Plastic Package

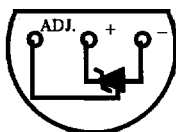

Bottom View

ABSOLUTE MAXIMUM RATING

| | |
|---------------------------------|-------------------|
| Forward Current..... | 10 mA |
| Reverse Current | 20 mA |
| Operating Temperature | |
| AS336AT..... | -55 °C to +125 °C |
| AS336BT/BN/BS | -25 °C to +85 °C |
| Storage Temperature Range | -65 °C to +150 °C |
| Lead Temperature | +300°C |

ELECTRICAL CHARACTERISTICS

Electrical Characteristics at $I_{in} = 1 \text{ mA}$, and $T_a = +25^\circ\text{C}$ unless otherwise noted.

| Parameters | Conditions | AS336AT | | | AS336BT | | | AS336BN/BS | | | Units |
|---|--|---------|-------|-------|---------|-------|-------|------------|-----|-------|----------|
| | | Min | Typ | Max | Min | Typ | Max | Min | Typ | Max | |
| Reference breakdown Voltage | | 2.475 | 2.500 | 2.525 | 2.450 | 2.500 | 2.550 | 2.450 | 2.5 | 2.550 | V |
| Reverse Dynamic Impedance | | | 0.2 | 0.6 | | 0.2 | 1 | | 0.2 | 1.0 | Ω |
| Reverse Breakdown Voltage Change with current | $400\text{mA} \leq I_{in} \leq 10\text{mA}$ A | | | 6 | | | 10 | | | 10 | mV |
| Temperature Coeff. Note 1 | $T_{min} \leq T_a \leq T_{max}$ | | 25 | 50 | | 25 | 50 | | 25 | 50 | ppm/°C |
| Long Term Stability | | | 20 | | | 20 | | | 20 | | ppm/KHr |

Note 1: Three-point measurement guarantees the error band over the specified temperature range.

Application Hints

The AS336 voltage reference is much easier to use than ordinary zener diodes. Their low impedance and wide operating current range simplify biasing in almost any circuit. To optimize the system performance the AS336 breakdown voltage or the temperature coefficient can be adjusted.

Figure 1 shows an AS336 with a 10K potentiometer for adjusting the reverse breakdown voltage. By adding resistor R1 the breakdown voltage can be adjusted without affecting the Tempco of the device. The adjustment range is usually sufficient to adjust for both the initial device tolerance and inaccuracies in buffer circuitry.

If minimum temperature coefficient is desired, four diodes can be added in series with the adjustment potentiometer as seen in Figure 2. The temperature coefficient is at its lows when it is adjusted to 5.00 Volts. Any diode such as 1N914, 1N4148 or a 1N457 can be used for this propose. The thermal environment of the diodes should be the same as the AS336 for proper temperature compensation. The absolute resistance of the network is not critical and any value from 2K to 20K will work. Due to the wide range of adjustment, fixed resistors should be connected in series with the pot to make pot setting critical.

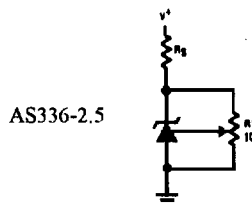

Figure 1. AS336 With Pot for Adjustment of Breakdown Voltage

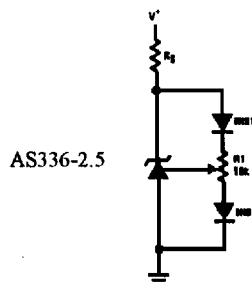
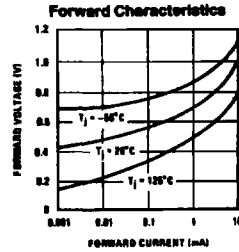
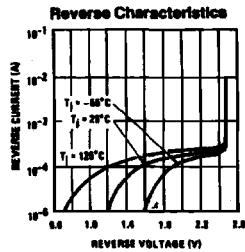
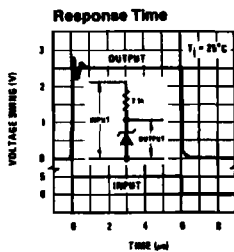
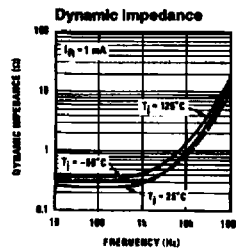
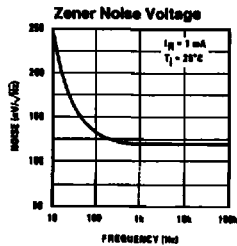
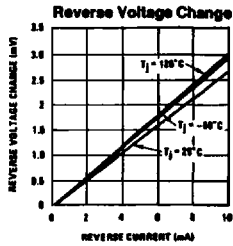
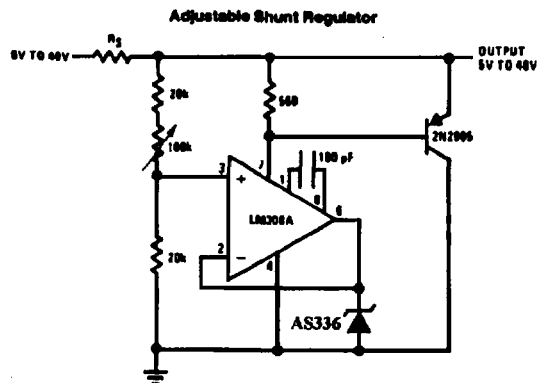

Figure 2. Temperature Coefficient Adjustment

TYPICAL PERFORMANCE CHARACTERISTICS



TYPICAL APPLICATIONS



TYPICAL APPLICATIONS

Bipolar Output Reference

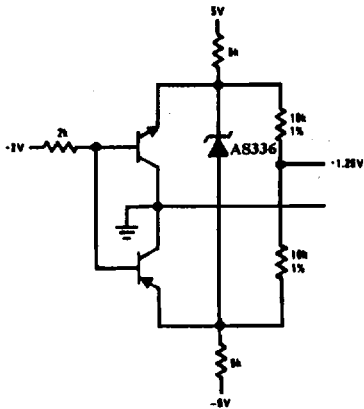

Op Amp with Output Clamped

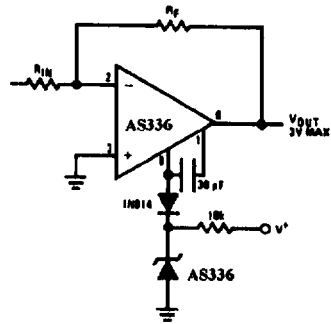

5V Crowbar

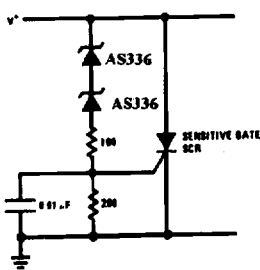

2.5V Reference with Minimum Temperature Coefficient

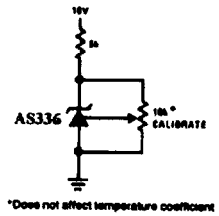
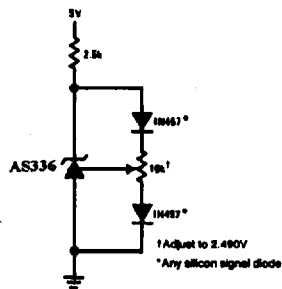

SCHEMATIC DIAGRAM

