

Introduction

The AAT1145 Evaluation Board contains a fully tested 1.2A, 1.5MHz step-down DC/DC regulator. The circuit has an input voltage range of 2.5V to 5.5V and a 1.8V output capable of delivering up to 1.2A output current with a 3.6V V_{IN} . The output is adjustable from 0.6V to V_{IN} . The circuit can provide up to 96% efficiency and it consumes less than 1 μ A in shutdown mode. In light load mode operation there is very low output ripple voltage for noise-sensitive applications.

The AAT1145 comes in a small 10-pin DFN package, which has an exposed pad on the bottom-side of the IC for better thermal performance. The board has a ground pad just below the exposed pad for reliable soldering and better thermal dissipation. These features, plus the nominal operating frequency of 1.5MHz allowing the use of low profile surface mount components, make the AAT1145 an ideal circuit for use in battery-powered, hand-held applications.

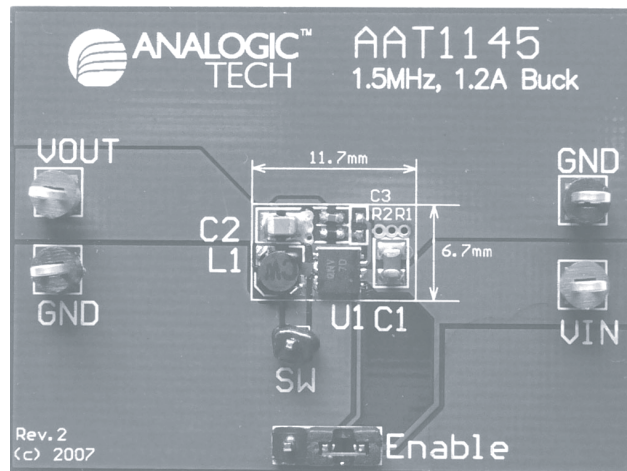

Figure 1: AAT1145 Evaluation Board.

Layout Guidelines

The following guidelines should be followed to ensure proper operation of the AAT1145:

1. The Exposed Pad (EP) must be reliably soldered to GND. A large pad under the device is strongly recommended for heat sinking purposes.
2. The power traces, including the GND trace, the LX-to-L1-to-VOUT trace and the VIN-to-IN trace should be kept short, direct and wide to allow large current flow. Put many multiple-layer VIA pads when connecting traces change between layers.
3. Connect the input capacitor C1 to the IN and AIN pins as close as possible to get good power filtering.
4. Keep the switching node, LX pin 7 and 8, away from the sensitive FB/OUT node.
5. To avoid large GND noise affecting the accurate reference circuit, it is recommended that pin 4 and pin 6 AGND connect to the GND plane to a single point under the device.

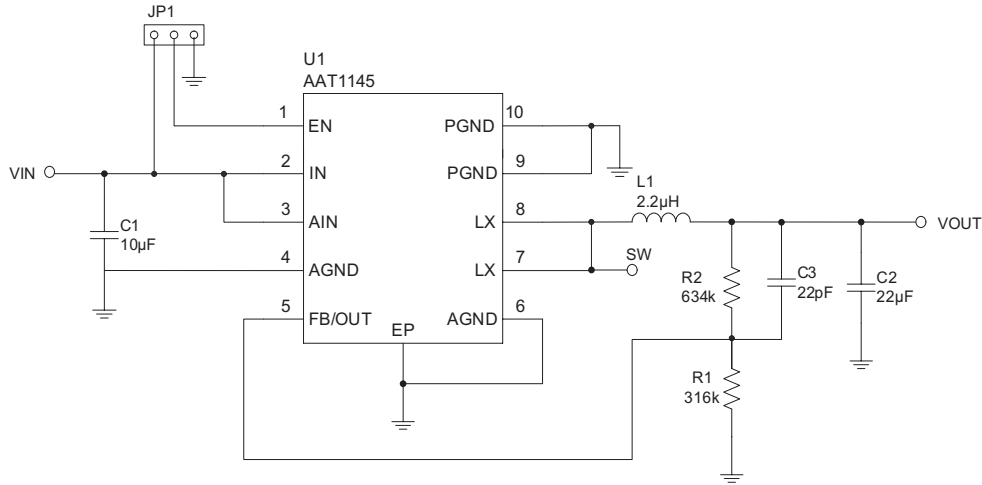

Figure 2: AAT1145 Evaluation Board Schematic.

Specification	Test Conditions	Min	Typ	Max	Units
Input Voltage		2.5	3.6	5.5	V
Output Error Voltage			±3		%
Output Current		0		1200	mA

Table 1: AAT1145 Evaluation Board Specifications.

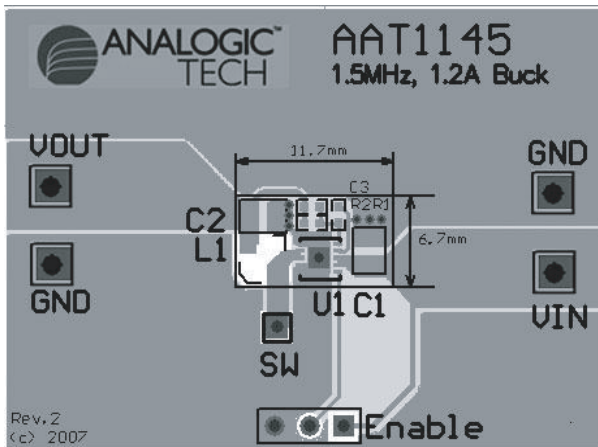

Figure 3: AAT1145 Evaluation Board PCB Top Side.

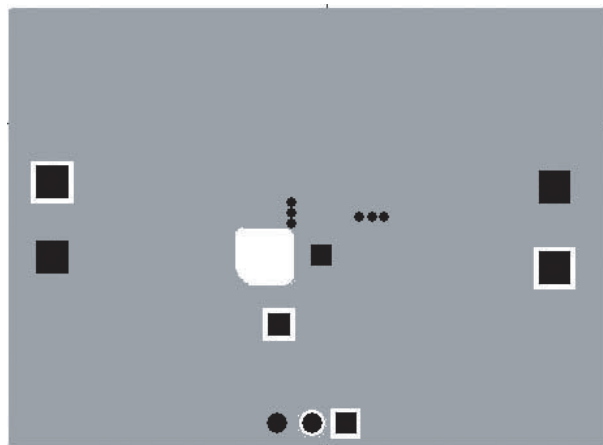

Figure 4: AAT1145 Evaluation Board PCB Bottom Side.

Test Equipment

1. 8.0V 5.0A laboratory power supply: Agilent E3648A or equivalent.
2. Electronic load: Agilent N3301A
3. DC voltmeter: Agilent 34401A or equivalent.
4. Oscilloscope: Tektronix TDS3034B or equivalent.

Setup and Test (see connection diagram in Figure 5)

A: Load and Line Regulation

1. Apply a DC power supply and DC voltmeter across the input voltage terminals: VIN (positive terminal) and GND (negative terminal or return).
2. Apply a DC load and DC voltmeter to the output terminals: VOUT and GND.
3. Before turning on the supply, set the jumper to the side labeled “Enable”.
4. Vary the load from 0 to 1.2A and the input voltage from 2.5V to 5.5V while monitoring the output voltage.
5. The output voltage as measured at the output terminals of the evaluation boards should not vary by more than $\pm 3\%$ of the nominal voltage.

B: Ripple and Shutdown Current

1. Set the output load current between 0A and 1.2A, and measure the output ripple voltage; the measurement should be less than 20 mVAC.
2. Apply 4.2V at VIN. Set the jumper from “Enable” state to GND. Measure the shutdown supply current. The supply current will be less than 1 μ A.

C: Short-Circuit and Over-Temperature Protection

1. Raise the input voltage to 5.5V.
2. Apply a short from VOUT to GND at the evaluation board terminals.
3. Remove the short and verify that the output returns to its initial value.

D: Enable Output

1. Short the Enable pin to GND. The output should decay to zero.
2. Remove the short applied to the Enable pin. The output should recover to its initial value.

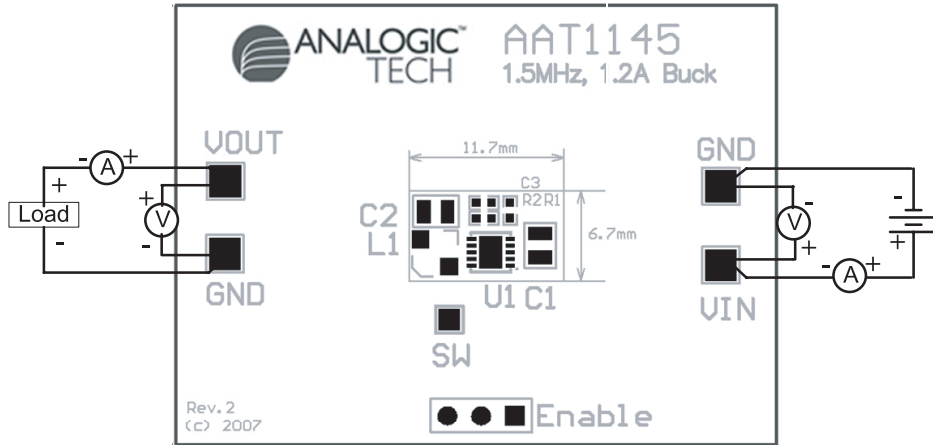

Figure 5: AAT1145 Connection Diagram.

Waveforms

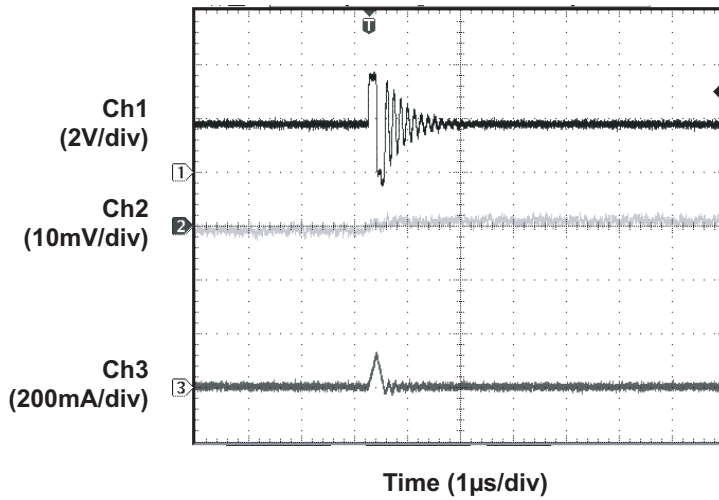

Figure 6: Light Load Switching Waveforms
($V_{IN} = 3.6V$, $V_{OUT} = 1.8V$, No Load;
Ch1: (SW) LX pin, Ch2: V_{OUT} (AC),
Ch3: LX $I_{INDUCTOR}$).

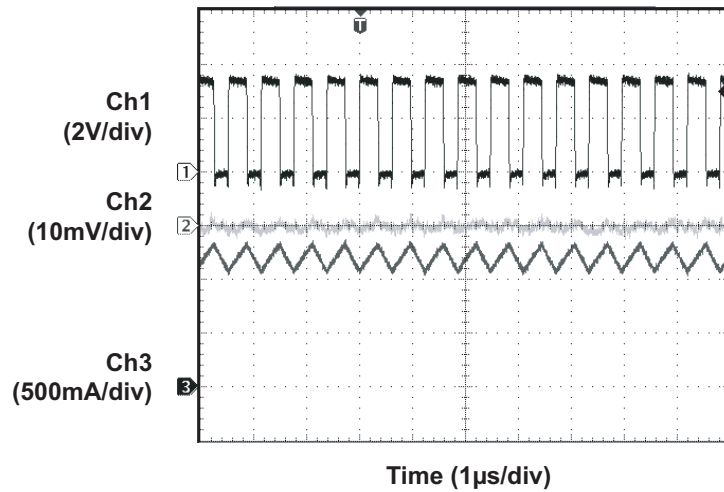

Figure 7: Full Load Switching Waveforms
 ($V_{IN} = 3.6V$, $V_{OUT} = 1.8V$, 1.2A Load;
 Ch1: (SW) LX pin, Ch2: V_{OUT} (AC),
 Ch3: LX $I_{INDUCTOR}$).

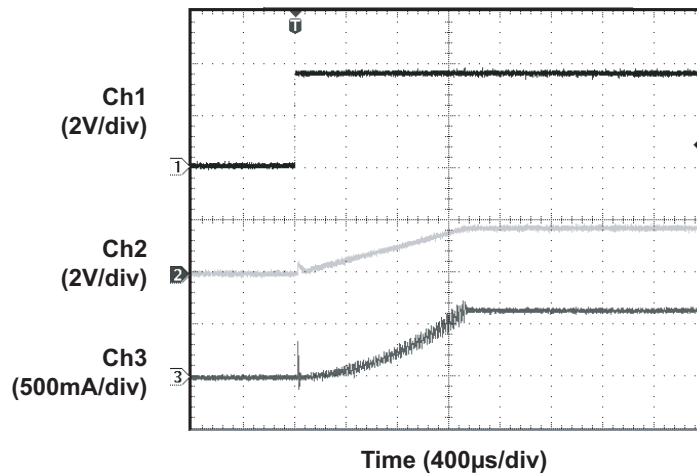

Figure 8: Startup Waveforms
 $V_{IN} = 3.6V$, $V_{OUT} = 1.8V$, 3Ω Load;
 Ch1: EN, Ch2: V_{OUT} , Ch3: I_{IN} .

Component	Part Number	Description	Manufacturer
U1	AAT1145	1.5 MHz, 1.2A Synchronous Step-Down Converter	Analogic Tech
L1	CDRH2D14NP-2R2NC	Inductor 2.2uH 1.5A SMD	Sumida
C1	GRM21BR61C106K	Cap Ceramic 10uF 0805 X5R 16V10%	Murata
C2	GRM21BR60J226M	Cap Ceramic 10uF 0805 X5R 6.3V 20%	Murata
C3	C1005COG1H220JT000P	Cap Ceramic 22pF 0402 C0G 50V 5%	TDK
R1	Chip Resistor	Res 316K Ω 1/16W 1% 0402 SMD	Any
R2	Chip Resistor	Res 634k Ω 1/16W 1% 0402 SMD	Any

Table 2: AAT1145 EVAL Bill of Materials.

Output Voltage

There are two versions of the AAT1145, a fixed 1.8V output (AAT1145IDE-1.8) without feedback resistors R1 and R2, and an adjustable version that is set to 0.6V. To adjust the output from the 0.6V default, set R1 to 316k Ω and select R2 according to Table 3. A smaller value resistor divider can be used for better noise immunity, values are shown in columns 2 and 5. A larger value resistor divider is used as default for lower current consumption in columns 3 and 6. Standard 1% resistor values are substituted for calculated values.

V_{OUT} (V)	R1=59k Ω R2 (k Ω)	R1=316k Ω R2 (k Ω)	V_{OUT} (V)	R1=59k Ω R2 (k Ω)	R1=316k Ω R2 (k Ω)
0.6	19.6	0(short)	1.4	88.7	422
0.8	29.4	105	1.5	118	475
0.9	39.2	158	1.8	124	634
1.0	49.9	210	1.85	137	655
1.1	59.0	261	2.5	187	1000
1.2	68.1	316	3.0	294	1270
1.3	78.7	365	3.3	267	1430

Table 3: Resistor Selection for Adjustable Output Voltage.

© Advanced Analogic Technologies, Inc.

AnalogicTech cannot assume responsibility for use of any circuitry other than circuitry entirely embodied in an AnalogicTech product. No circuit patent licenses, copyrights, mask work rights, or other intellectual property rights are implied. AnalogicTech reserves the right to make changes to their products or specifications or to discontinue any product or service without notice. Except as provided in AnalogicTech's terms and conditions of sale, AnalogicTech assumes no liability whatsoever, and AnalogicTech disclaims any express or implied warranty relating to the sale and/or use of AnalogicTech products including liability or warranties relating to fitness for a particular purpose, merchantability, or infringement of any patent, copyright or other intellectual property right. In order to minimize risks associated with the customer's applications, adequate design and operating safeguards must be provided by the customer to minimize inherent or procedural hazards. Testing and other quality control techniques are utilized to the extent AnalogicTech deems necessary to support this warranty. Specific testing of all parameters of each device is not necessarily performed. AnalogicTech and the AnalogicTech logo are trademarks of Advanced Analogic Technologies Incorporated. All other brand and product names appearing in this document are registered trademarks or trademarks of their respective holders.

Advanced Analogic Technologies, Inc.
 3230 Scott Boulevard, Santa Clara, CA 95054
 Phone (408) 737-4600
 Fax (408) 737-4611

