

PKB 4000B PI
Intermediate Bus Converters, Input 36-75 V, 40 A / 240 W

EN/LZT 146 384 R2A Dec 2008

© Ericsson Power Modules AB

Key Features

- Industry standard low profile Eighth-brick 58.4 x 22.7 x 10.1 mm (2.3 x 0.894 x 0.397 in.)
- High efficiency, typ. 95 % at 12 V half load
- 1500 Vdc input to output isolation
- Meets isolation requirements equivalent to basic insulation according to IEC/EN/UL 60950
- More than 1.3 million hours MTBF

General Characteristics

- N+1 parallelable
- Input under voltage protection
- Over temperature protection
- Output over voltage protection
- Output short-circuit protection
- Remote control
- Optional baseplate
- Highly automated manufacturing ensures quality
- ISO 9001/14001 certified supplier

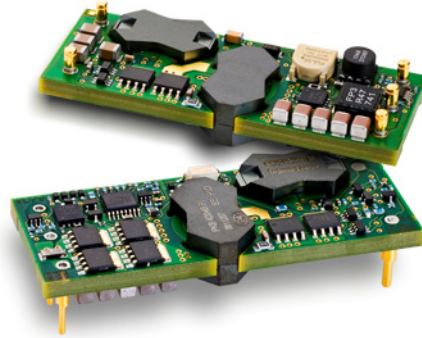

Safety Approvals



Design for Environment



Meets requirements in high-temperature lead-free soldering processes.

Contents

| | | |
|-------------------------------------|--------------------------|---------------------|
| General Information | | 2 |
| Safety Specification | | 3 |
| Absolute Maximum Ratings | | 4 |
| Product Program | Ordering No. | |
| 5.0 V, 40 A / 200 W | Electrical Specification | PKB 4201B PI..... 5 |
| 12.0 V, 20 A / 240 W | Electrical Specification | PKB 4204B PI..... 8 |
| EMC Specification | | 11 |
| Operating Information | | 12 |
| Thermal considerations | | 13 |
| Connections | | 14 |
| Mechanical Information | | 15 |
| Soldering Information | | 18 |
| Delivery Information | | 19 |
| Product Qualification Specification | | 20 |

PKB 4000B PI
Intermediate Bus Converters, Input 36-75 V, 40 A / 240 W

EN/LZT 146 384 R2A Dec 2008

© Ericsson Power Modules AB

General Information

Ordering Information

See Contents for individual product ordering numbers.

| Option | Suffix | Ordering No. |
|--------------------------------|--------|----------------|
| Surface mount | SI | PKB 4204B SI |
| Positive Remote Control Logic | P | PKB 4204B PIP |
| Lead length 3.69 mm (0.145 in) | LA | PKB 4204B PILA |
| Lead length 4.57 mm (0.180 in) | LB | PKB 4204B PILB |
| Increased stand-off height | M | PKB 4204B PIM |
| Baseplate | HS | PKB 4204B PIHS |

Note 1: As an example a positive logic, short pin product with baseplate would be PKB 4204 PIPHSLA.

Reliability

The Mean Time Between Failure (MTBF) is calculated at full output power and an operating ambient temperature (T_A) of +40°C, which is a typical condition in Information and Communication Technology (ICT) equipment. Different methods could be used to calculate the predicted MTBF and failure rate which may give different results. Ericsson Power Modules currently uses Telcordia SR332.

Predicted MTBF for the series is:

- 1.3 million hours according to Telcordia SR332, issue 1, Black box technique.

Telcordia SR332 is a commonly used standard method intended for reliability calculations in ICT equipment. The parts count procedure used in this method was originally modelled on the methods from MIL-HDBK-217F, Reliability Predictions of Electronic Equipment. It assumes that no reliability data is available on the actual units and devices for which the predictions are to be made, i.e. all predictions are based on generic reliability parameters.

Compatibility with RoHS requirements

The products are compatible with the relevant clauses and requirements of the RoHS directive 2002/95/EC and have a maximum concentration value of 0.1% by weight in homogeneous materials for lead, mercury, hexavalent chromium, PBB and PBDE and of 0.01% by weight in homogeneous materials for cadmium.

Exemptions in the RoHS directive utilized in Ericsson Power Modules products include:

- Lead in high melting temperature type solder (used to solder the die in semiconductor packages)
- Lead in glass of electronics components and in electronic ceramic parts (e.g. fill material in chip resistors)
- Lead as an alloying element in copper alloy containing up to 4% lead by weight (used in connection pins made of Brass)

Quality Statement

The products are designed and manufactured in an industrial environment where quality systems and methods like ISO 9000, 6 σ (sigma), and SPC are intensively in use to boost the continuous improvements strategy. Infant mortality or early failures in the products are screened out and they are subjected to an ATE-based final test. Conservative design rules, design reviews and product qualifications, plus the high competence of an engaged work force, contribute to the high quality of our products.

Warranty

Warranty period and conditions are defined in Ericsson General Terms and Conditions of Sale.

Limitation of Liability

Ericsson does not make any other warranties, expressed or implied including any warranty of merchantability or fitness for a particular purpose (including, but not limited to, use in life support applications, where malfunctions of product can cause injury to a person's health or life).

PKB 4000B PI
Intermediate Bus Converters, Input 36-75 V, 40 A / 240 W

EN/LZT 146 384 R2A Dec 2008

© Ericsson Power Modules AB

Safety Specification

General information

Ericsson Power Modules DC/DC converters and DC/DC regulators are designed in accordance with safety standards IEC/EN/UL60950, *Safety of Information Technology Equipment*.

IEC/EN/UL60950 contains requirements to prevent injury or damage due to the following hazards:

- Electrical shock
- Energy hazards
- Fire
- Mechanical and heat hazards
- Radiation hazards
- Chemical hazards

On-board DC-DC converters and DC/DC regulators are defined as component power supplies. As components they cannot fully comply with the provisions of any Safety requirements without "Conditions of Acceptability". Clearance between conductors and between conductive parts of the component power supply and conductors on the board in the final product must meet the applicable Safety requirements. Certain conditions of acceptability apply for component power supplies with limited stand-off (see Mechanical Information for further information). It is the responsibility of the installer to ensure that the final product housing these components complies with the requirements of all applicable Safety standards and Directives for the final product.

Component power supplies for general use should comply with the requirements in IEC60950, EN60950 and UL60950 "*Safety of information technology equipment*". There are other more product related standards, e.g. IEEE802.3af "Ethernet LAN/MAN Data terminal equipment power", and ETS300132-2 "Power supply interface at the input to telecommunications equipment; part 2: DC", but all of these standards are based on IEC/EN/UL60950 with regards to safety.

Ericsson Power Modules DC/DC converters and DC/DC regulators are UL60950 recognized and certified in accordance with EN60950.

The flammability rating for all construction parts of the products meets requirements for V-0 class material according to IEC 60695-11-10.

The products should be installed in the end-use equipment, in accordance with the requirements of the ultimate application. Normally the output of the DC/DC converter is considered as SELV (Safety Extra Low Voltage) and the input source must be isolated by minimum Double or Reinforced Insulation from the primary circuit (AC mains) in accordance with IEC/EN/UL60950.

Isolated DC/DC converters

It is recommended that a slow blow fuse with a rating twice the maximum input current per selected product be used at the input of each DC/DC converter. If an input filter is used in the circuit the fuse should be placed in front of the input filter.

In the rare event of a component problem in the input filter or in the DC/DC converter that imposes a short circuit on the input source, this fuse will provide the following functions:

- Isolate the faulty DC/DC converter from the input power source so as not to affect the operation of other parts of the system.
- Protect the distribution wiring from excessive current and power loss thus preventing hazardous overheating.

The galvanic isolation is verified in an electric strength test. The test voltage (V_{iso}) between input and output is 1500 Vdc or 2250 Vdc for 60 seconds (refer to product specification).

Leakage current is less than 1 μ A at nominal input voltage.

24 V DC systems

The input voltage to the DC/DC converter is SELV (Safety Extra Low Voltage) and the output remains SELV under normal and abnormal operating conditions.

48 and 60 V DC systems

If the input voltage to the DC/DC converter is 75 Vdc or less, then the output remains SELV (Safety Extra Low Voltage) under normal and abnormal operating conditions.

Single fault testing in the input power supply circuit should be performed with the DC/DC converter connected to demonstrate that the input voltage does not exceed 75 Vdc.

If the input power source circuit is a DC power system, the source may be treated as a TNV2 circuit and testing has demonstrated compliance with SELV limits and isolation requirements equivalent to Basic Insulation in accordance with IEC/EN/UL60950.

Non-isolated DC/DC regulators

The input voltage to the DC/DC regulator is SELV (Safety Extra Low Voltage) and the output remains SELV under normal and abnormal operating conditions.

PKB 4000B PI
Intermediate Bus Converters, Input 36-75 V, 40 A / 240 W

EN/LZT 146 384 R2A Dec 2008

© Ericsson Power Modules AB

Absolute Maximum Ratings

| Characteristics | | min | typ | max | Unit |
|-----------------|--|-----------------------|------|------|------|
| T_{ref} | Operating Temperature (see Thermal Consideration section) | -40 | | +125 | °C |
| T_s | Storage temperature | -40 | | +125 | °C |
| V_I | Input voltage | -0.5 | | +80 | V |
| V_{iso} | Isolation voltage (input to output test voltage) | | | 1500 | Vdc |
| V_{tr} | Input voltage transient (t_p 100 ms) | | | 100 | V |
| V_{RC} | Remote Control pin voltage (see Operating Information section) | Positive logic option | | 15 | V |
| | | Negative logic option | -0.5 | 15 | V |

Stress in excess of Absolute Maximum Ratings may cause permanent damage. Absolute Maximum Ratings, sometimes referred to as no destruction limits, are normally tested with one parameter at a time exceeding the limits of Output data or Electrical Characteristics. If exposed to stress above these limits, function and performance may degrade in an unspecified manner.

Fundamental Circuit Diagram

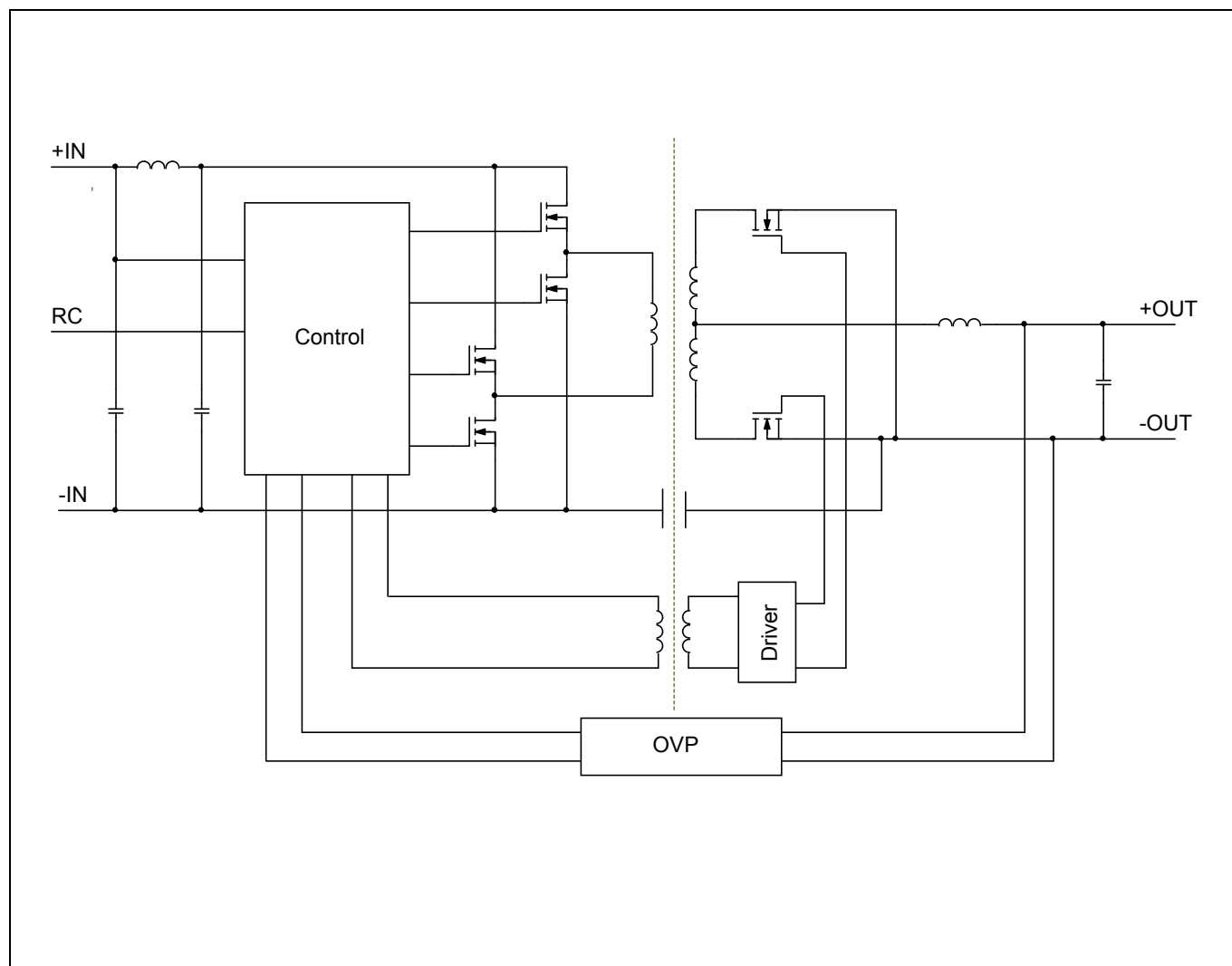

| | |
|--|-----------------------------|
| PKB 4000B PI Intermediate Bus Converters, Input 36-75 V, 40 A / 240 W | EN/LZT 146 384 R2A Dec 2008 |
| | © Ericsson Power Modules AB |

5 V, 40 A / 200 W Electrical Specification
PKB 4201B PI
 $T_{ref} = -30$ to $+90$ °C, $V_I = 36$ to 75 V, unless otherwise specified under Conditions.

 Typical values given at: $T_{ref} = +25$ °C, $V_I = 53$ V, max I_O , unless otherwise specified under Conditions.

| Characteristics | | Conditions | min | Typ | max | Unit |
|-----------------|----------------------------|-----------------------------------|-----|------|-----|------|
| V_I | Input voltage range | | 36 | | 75 | V |
| V_{loff} | Turn-off input voltage | Decreasing input voltage | 32 | 33 | 35 | V |
| V_{lon} | Turn-on input voltage | Increasing input voltage | 33 | 35 | 36 | V |
| C_I | Internal input capacitance | | | 11 | | µF |
| P_O | Output power | $V_I = 75$ V | 0 | | 194 | W |
| | | $V_I = 53$ V | 0 | | 194 | |
| | | $V_I = 36$ V | 0 | | 194 | |
| η | Efficiency | 50 % of max I_O , $V_I = 53$ V | | 94.5 | | % |
| | | max I_O , $V_I = 53$ V | | 94.0 | | |
| P_d | Power Dissipation | max I_O | | 12 | 18 | W |
| P_{li} | Input idling power | $I_O = 0$ A, $V_I = 53$ V | | 4 | | W |
| P_{RC} | Input standby power | $V_I = 53$ V (turned off with RC) | | 0.12 | | W |
| f_s | Switching frequency | 0-100 % of max I_O | | 180 | | kHz |

| | | | | | | |
|-----------|--|--|------|------|-----|-------|
| V_{Oi} | Output voltage initial setting and accuracy | $T_{ref} = +25$ °C, $V_I = 53$ V, $I_O = 20$ A | 4.9 | 5.0 | 5.1 | V |
| V_O | Output voltage tolerance band | 0-100 % of max I_O , $V_I = 36$ V to 75 V, see Note 3 | 4.5 | | 5.5 | V |
| | Idling voltage | $I_O = 0$ A | 4.75 | | 5.5 | V |
| | Line regulation | $V_I = 36$ V to 75 V | | 0.04 | | V |
| | Load regulation | $V_I = 53$ V, 0-100 % of max I_O | 0.1 | 0.25 | 0.4 | V |
| V_{tr} | Load transient voltage deviation | $V_I = 53$ V, Load step 50-75-50 % of max I_O , $di/dt = 1$ A/µs, see Note 1 | | 0.27 | | V |
| t_{tr} | Load transient recovery time | | | 0.06 | | ms |
| t_r | Ramp-up time (from 10-90 % of V_O) | 0-100 % of max I_O , see Note 1 & 2 | 1 | 4 | 7 | ms |
| t_s | Start-up time (from V_I connection to 90 % of V_O) | | 5 | 10 | 14 | ms |
| t_f | V_I shut-down fall time (from V_I off to 10 % of V_O) | max I_O , see Note 1 | | 0.5 | | ms |
| | | $I_O = 0$ A, see Note 1 | | 16 | | s |
| t_{RC} | RC start-up time | max I_O , see Note 1 & 2 | | 7 | | ms |
| | RC shut-down fall time (from RC off to 10 % of V_O) | max I_O , see Note 1 | | 0.3 | | ms |
| | | $I_O = 0$ A, see Note 1 | | 16 | | s |
| I_O | Output current | | 0 | | 40 | A |
| I_{lim} | Current limit threshold | $T_{ref} < \max T_{ref}$ | 42 | 50 | 65 | A |
| I_{sc} | Short circuit current | $T_{ref} = 25$ °C | | 53 | | A |
| C_{out} | Recommended Capacitive Load | $T_{ref} = 25$ °C, see Note 4 | 1000 | | | µF |
| V_{Oac} | Output ripple & noise | See ripple & noise section, max I_O | | 110 | 220 | mVp-p |
| OVP | Input over voltage protection | | | 79 | | V |
| | Output over voltage protection | | | 7.3 | | |

Note 1: A 1 mF external output capacitance was used (ESR approx. 20 mohm).

Note 2: At ramp up with low load will the output voltage have a negative slope during a short time.

Note 3: Negative temperature coefficient: -3 mV/°C.

Note 4: Low ESR type.

PKB 4000B PI
Intermediate Bus Converters, Input 36-75 V, 40 A / 240 W

EN/LZT 146 384 R2A Dec 2008

© Ericsson Power Modules AB

5 V, 40 A / 200 W Typical Characteristics

Efficiency

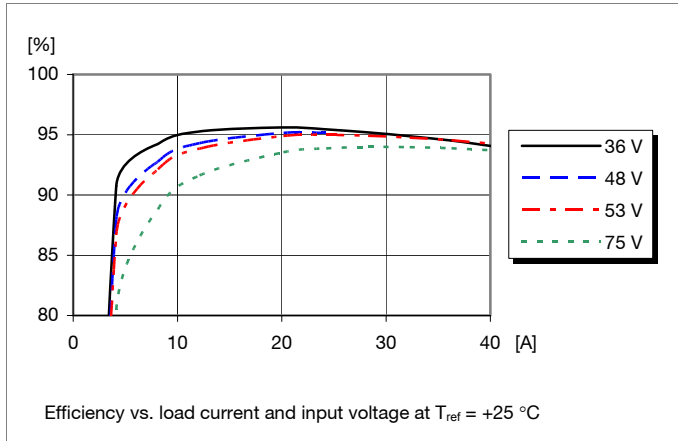

Power Dissipation

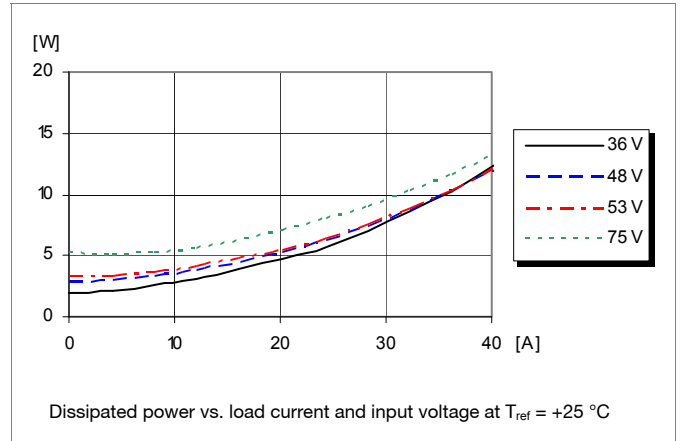

Output Current Derating, open frame

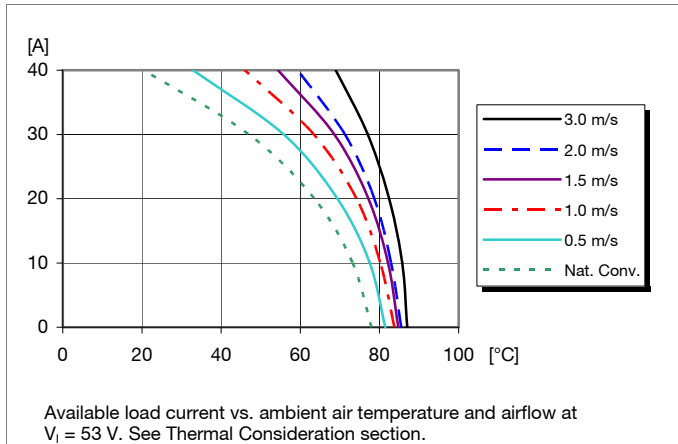

Output Current Derating, base plate option

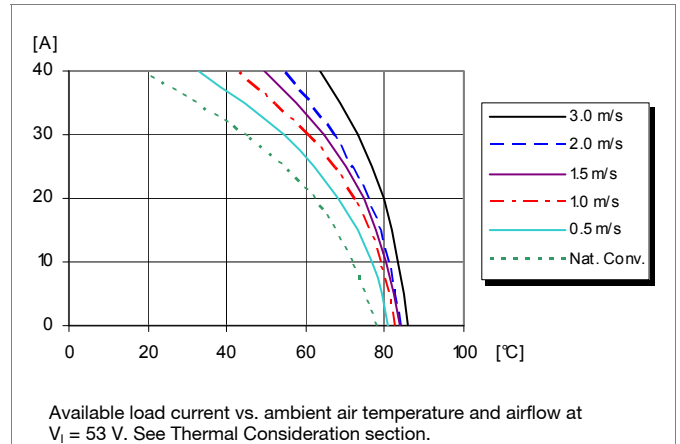

Output Characteristics

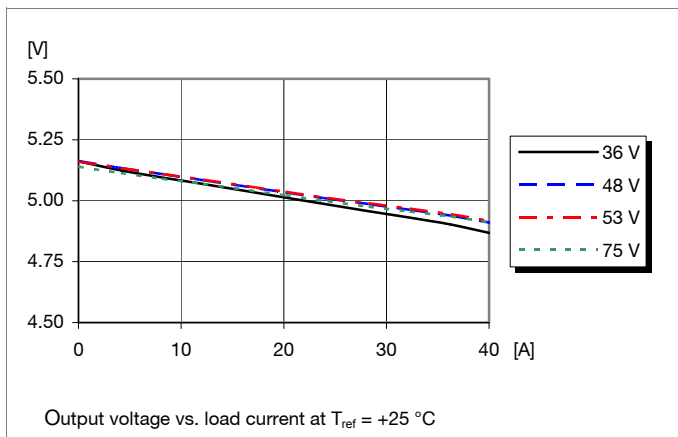

Current Limit Characteristics

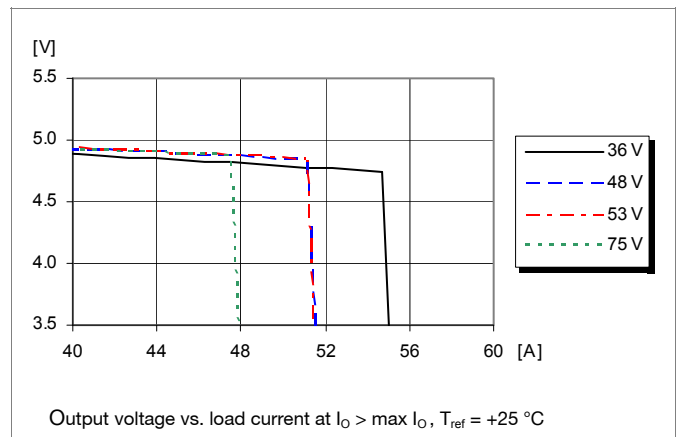

PKB 4000B PI
Intermediate Bus Converters, Input 36-75 V, 40 A / 240 W

EN/LZT 146 384 R2A Dec 2008

© Ericsson Power Modules AB

5 V, 40 A / 200 W Typical Characteristics

PKB 4201B PI

Start-up

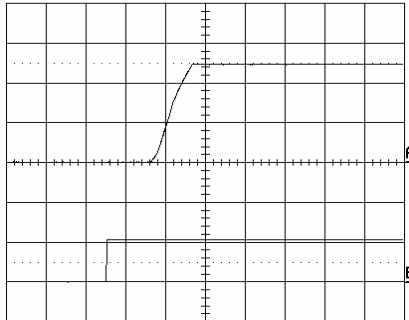

Start-up enabled by connecting V_i at:
 $T_{ref} = +25\text{ }^\circ\text{C}$, $V_i = 53\text{ V}$,
 $I_o = 40\text{ A}$ resistive load.
 $C_{out} = 1\text{ mF}$.

Top trace: output voltage (2 V/div.).
Bottom trace: input voltage (50 V/div.).
Time scale: (5 ms/div.).

Shut-down

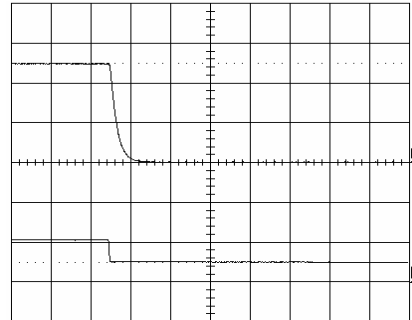

Shut-down enabled by disconnecting V_i at:
 $T_{ref} = +25\text{ }^\circ\text{C}$, $V_i = 53\text{ V}$,
 $I_o = 40\text{ A}$ resistive load.
 $C_{out} = 1\text{ mF}$.

Top trace: output voltage (2 V/div.).
Bottom trace: input voltage (50 V/div.).
Time scale: (1 ms/div.).

Output Ripple & Noise

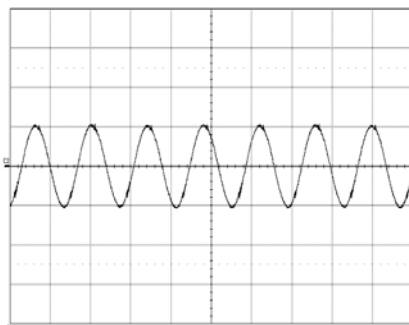

Output voltage ripple at:
 $T_{ref} = +25\text{ }^\circ\text{C}$, $V_i = 53\text{ V}$,
 $I_o = 40\text{ A}$ resistive load.

Trace: output voltage (50 mV/div.).
Time scale: (2 μs /div.).

Output Load Transient Response

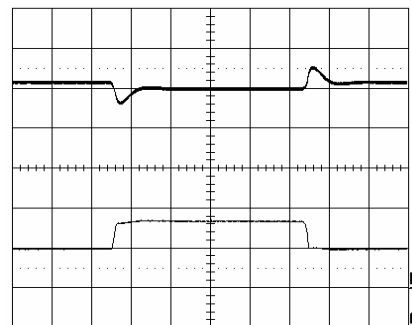

Output voltage response to load current step-
change (20-30-20 A) at:
 $T_{ref} = +25\text{ }^\circ\text{C}$, $V_i = 53\text{ V}$, $C_{out} = 1\text{ mF}$.

Top trace: output voltage (0.5 V/div.).
Bottom trace: load current (20 A/div.).
Time scale: (0.1 ms/div.).

| | |
|--|-----------------------------|
| PKB 4000B PI Intermediate Bus Converters, Input 36-75 V, 40 A / 240 W | EN/LZT 146 384 R2A Dec 2008 |
| | © Ericsson Power Modules AB |

12 V, 20 A / 240 W Electrical Specification
PKB 4204B PI
 $T_{ref} = -30$ to $+90$ °C, $V_I = 36$ to 75 V, unless otherwise specified under Conditions.

 Typical values given at: $T_{ref} = +25$ °C, $V_I = 53$ V, max I_O , unless otherwise specified under Conditions.

| Characteristics | | Conditions | min | Typ | max | Unit |
|-----------------|----------------------------|-----------------------------------|-----|------|-----|------|
| V_I | Input voltage range | | 36 | | 75 | V |
| V_{loff} | Turn-off input voltage | Decreasing input voltage | 32 | 33 | 35 | V |
| V_{lon} | Turn-on input voltage | Increasing input voltage | 33 | 35 | 36 | V |
| C_I | Internal input capacitance | | | 11 | | µF |
| P_O | Output power | $V_I = 75$ V | 0 | | 234 | W |
| | | $V_I = 53$ V | 0 | | 234 | |
| | | $V_I = 36$ V | 0 | | 220 | |
| η | Efficiency | 50 % of max I_O , $V_I = 53$ V | | 95.5 | | % |
| | | max I_O , $V_I = 53$ V | | 94.5 | | |
| P_d | Power Dissipation | max I_O | | 13.5 | 23 | W |
| P_{li} | Input idling power | $I_O = 0$ A, $V_I = 53$ V | | 3 | | W |
| P_{RC} | Input standby power | $V_I = 53$ V (turned off with RC) | | 0.1 | | W |
| f_s | Switching frequency | 0-100 % of max I_O | | 180 | | kHz |

| | | | | | | |
|-----------|--|--|-------|-------|-------|-------|
| V_{Oi} | Output voltage initial setting and accuracy | $T_{ref} = +25$ °C, $V_I = 53$ V, $I_O = 10$ A | 11.85 | 12.00 | 12.15 | V |
| V_O | Output voltage tolerance band | 0-100 % of max I_O , $V_I = 38$ V to 75 V, see Note 1 | 10.8 | | 12.6 | V |
| | Idling voltage | $I_O = 0$ A | 11.4 | | 12.6 | V |
| | Line regulation | $V_I = 38$ V to 75 V, see Note 2 | | 0.2 | | V |
| | Load regulation | $V_I = 53$ V, 0-100 % of max I_O | 0.3 | 0.6 | 0.9 | V |
| V_{tr} | Load transient voltage deviation | $V_I = 53$ V, Load step 50-75-50 % of max I_O , di/dt = 1 A/µs, see Note 3 | | 0.4 | | V |
| t_{tr} | Load transient recovery time | | | 0.25 | | ms |
| t_r | Ramp-up time (from 10-90 % of V_{Oi}) | 0-100 % of max I_O | 2 | 5.5 | 9 | ms |
| t_s | Start-up time (from V_I connection to 90 % of V_{Oi}) | | 6 | 11 | 16 | ms |
| t_f | V_I shut-down fall time (from V_I off to 10 % of V_O) | max I_O | | 0.1 | | ms |
| | | $I_O = 0$ A | | 0.35 | | s |
| t_{RC} | RC start-up time | max I_O | | 8 | | ms |
| | RC shut-down fall time (from RC off to 10 % of V_O) | max I_O | | 0.1 | | ms |
| | | $I_O = 0$ A | | 0.35 | | s |
| I_O | Output current | | 0 | | 20 | A |
| I_{lim} | Current limit threshold | $T_{ref} < \max T_{ref}$ | 21 | 27 | 33 | A |
| C_{out} | Recommended Capacitive Load | $T_{ref} = 25$ °C | 0 | | | µF |
| I_{sc} | Short circuit current | $T_{ref} = 25$ °C | | 29 | | A |
| V_{Oac} | Output ripple & noise | See ripple & noise section, max I_O | | 80 | 240 | mVp-p |
| OVP | Input over voltage protection | | | 79 | | V |
| | Output over voltage protection | | | 13.5 | | |

 Note 1: At $V_I = 36$ V to 38 V is the lower limit 10.5 V.

 Note 2: At $V_I = 36$ V to 75 V is the typical value 0.6 V.

Note 3: A 220 µF external output capacitance was with low ESR was used.

PKB 4000B PI
Intermediate Bus Converters, Input 36-75 V, 40 A / 240 W

EN/LZT 146 384 R2A Dec 2008

© Ericsson Power Modules AB

12 V, 20 A / 240 W Typical Characteristics

PKB 4204B PI

Efficiency

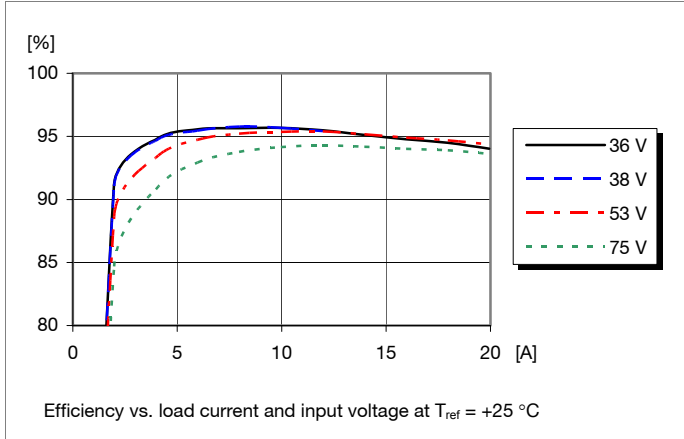

Power Dissipation

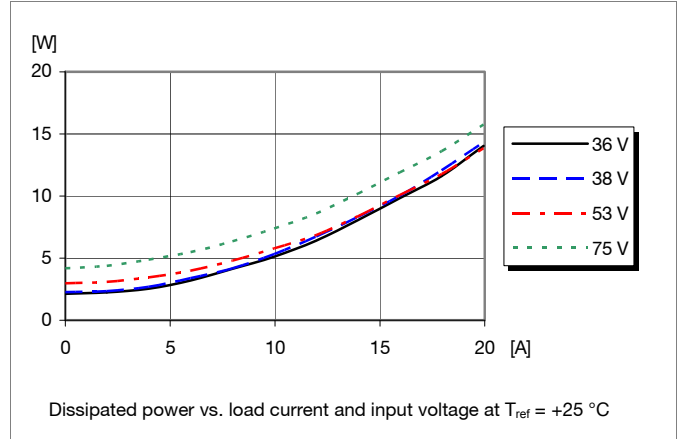

Output Current Derating, open frame

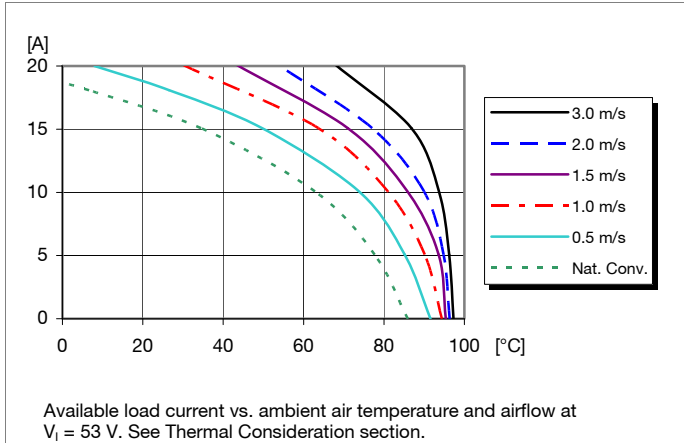

Output Current Derating, base plate option

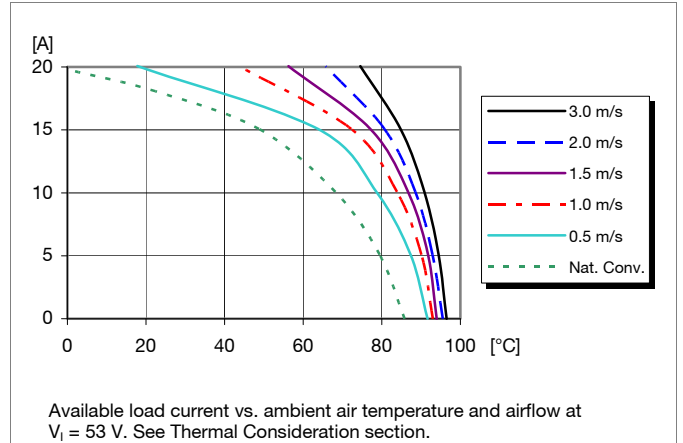

Output Characteristics

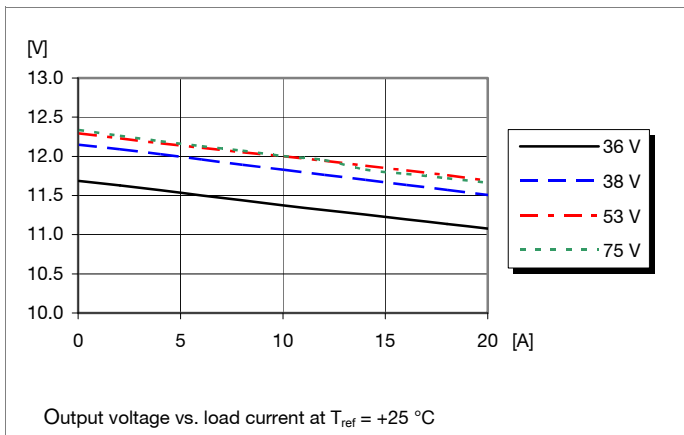

Current Limit Characteristics

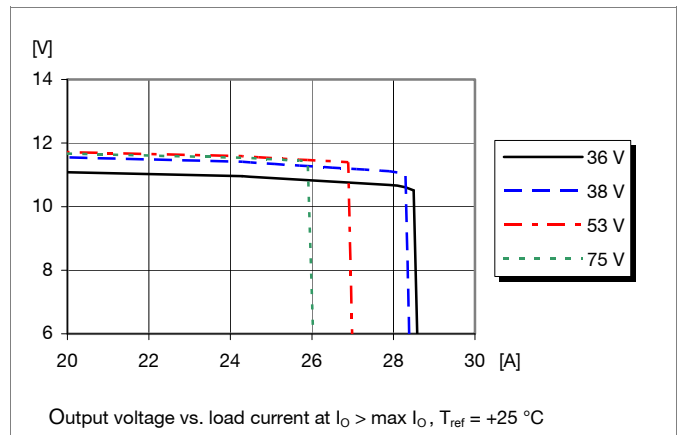

PKB 4000B PI
Intermediate Bus Converters, Input 36-75 V, 40 A / 240 W

EN/LZT 146 384 R2A Dec 2008
© Ericsson Power Modules AB

12 V, 20 A / 240 W Typical Characteristics

PKB 4204B PI

Start-up

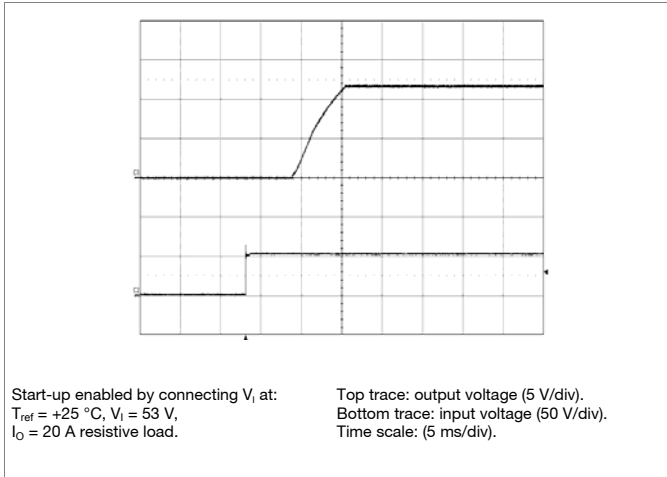

Shut-down

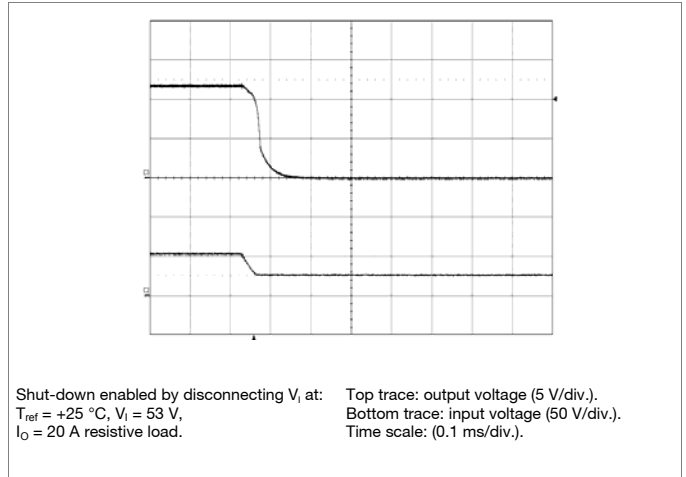

Output Ripple & Noise

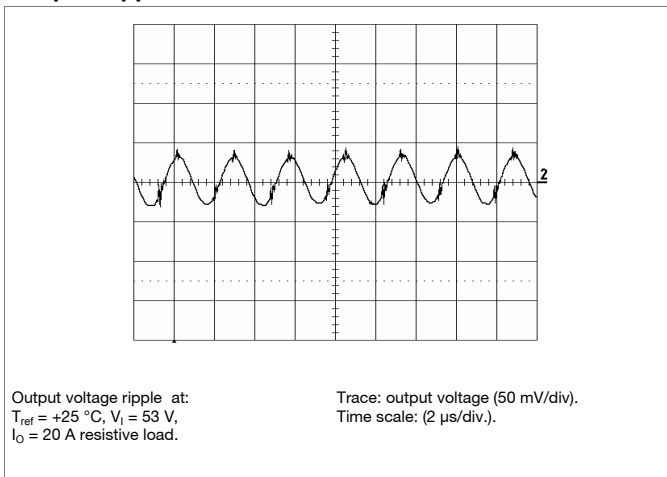

Output Load Transient Response

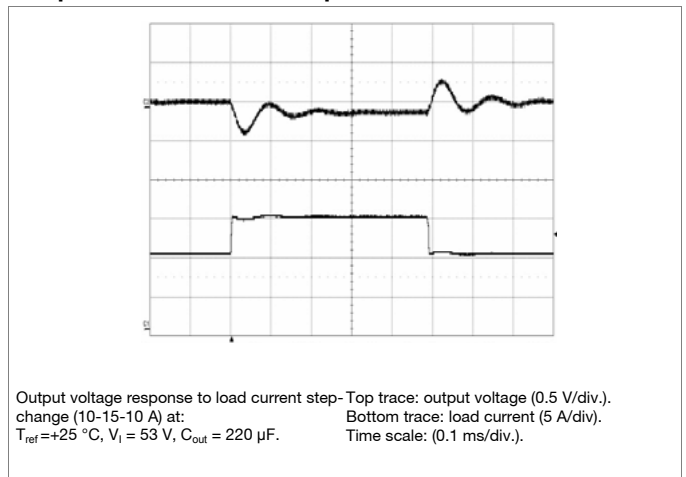

PKB 4000B PI
Intermediate Bus Converters, Input 36-75 V, 40 A / 240 W

EN/LZT 146 384 R2A Dec 2008

© Ericsson Power Modules AB

EMC Specification

Conducted EMI measured according to EN55022, CISPR 22 and FCC part 15J (see test set-up). See Design Note 009 for detailed information. The fundamental switching frequency is 180 kHz for PKB 4204B PI @ $V_I = 53$ V, max I_O .

Conducted EMI Input terminal value (typ)

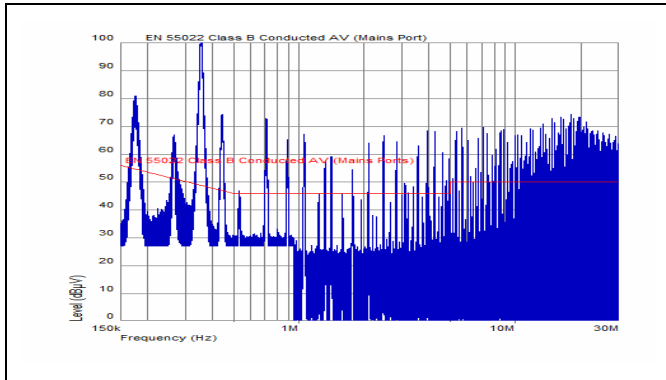

EMI without filter

External filter (class B)

Required external input filter in order to meet class B in EN 55022, CISPR 22 and FCC part 15J.

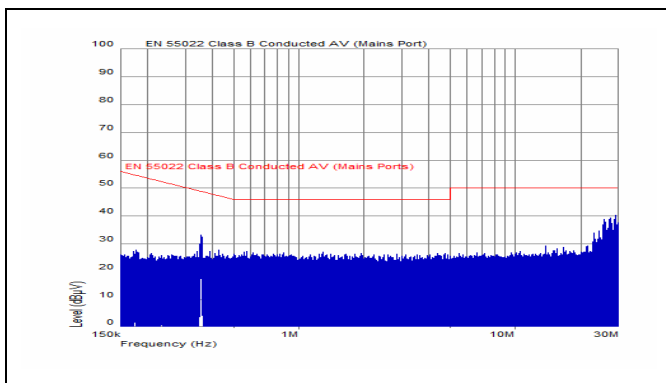
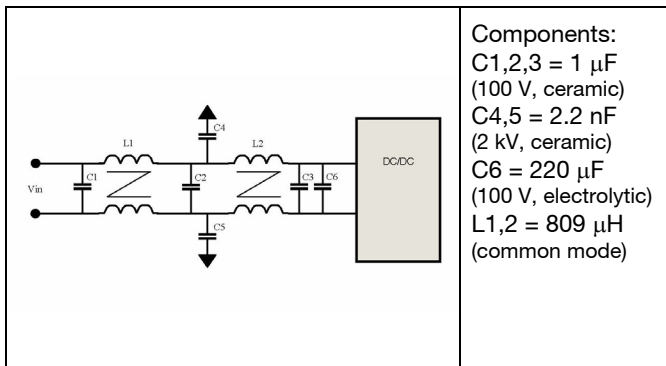

EMI with filter

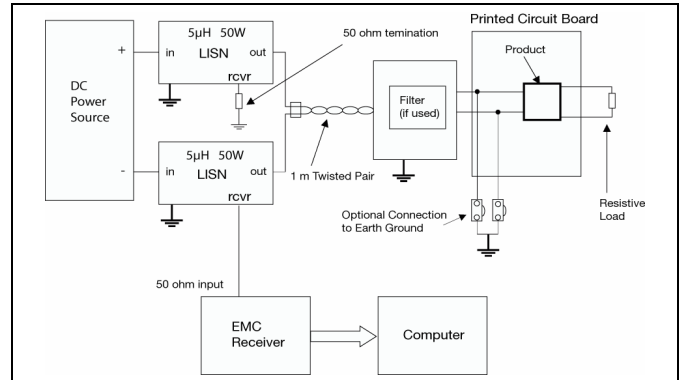

Test set-up

Layout recommendation

The radiated EMI performance of the DC/DC converter will depend on the PCB layout and ground layer design. It is also important to consider the stand-off of the DC/DC converter.

If a ground layer is used, it should be connected to the output of the DC/DC converter and the equipment ground or chassis.

A ground layer will increase the stray capacitance in the PCB and improve the high frequency EMC performance.

Output ripple and noise

Output ripple and noise measured according to figure below. See Design Note 022 for detailed information.

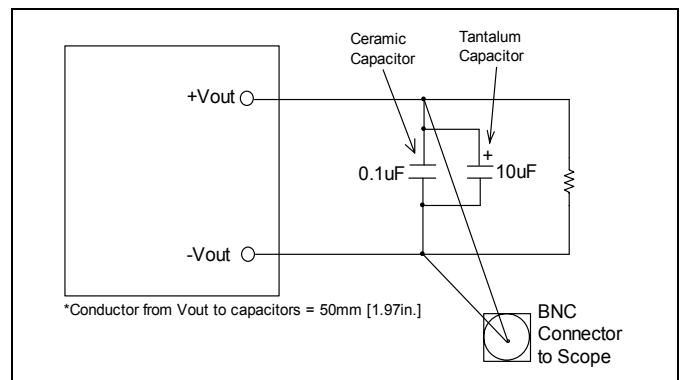

Output ripple and noise test setup

| | |
|--|--|
| PKB 4000B PI Intermediate Bus Converters, Input 36-75 V, 40 A / 240 W | EN/LZT 146 384 R2A Dec 2008 © Ericsson Power Modules AB |
|--|--|

Operating information

Input Voltage

The input voltage range 36 to 75 Vdc meets the requirements of the European Telecom Standard ETS 300 132-2 for normal input voltage range in -48 and -60 Vdc systems, -40.5 to -57.0 V and -50.0 to -72 V respectively. At input voltages exceeding 75 V, the power loss will be higher than at normal input voltage and T_{ref} must be limited to absolute max 125 °C. The absolute maximum continuous input voltage is 80 Vdc.

Turn-off Input Voltage

The DC/DC converters monitor the input voltage and will turn on and turn off at predetermined levels. The minimum hysteresis between on and off input voltage is 1.0 V.

Remote Control (RC)

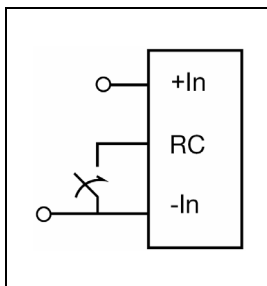

The products are fitted with a remote control function referenced to the primary negative input connection (- In), with positive logic option available. The RC function allows the product to be turned on/off by an external device like a semiconductor or mechanical switch. The RC pin has an internal pull up resistor to + In.

The maximum required sink current is less than 1 mA. When the RC pin is left open, the voltage generated on the RC pin is 5-10 V. The second option is "positive logic" remote control, which can be ordered by adding the suffix "P" to the end of the part number. The DC/DC converter will turn on when the input voltage is applied with the RC pin open. Turn off is achieved by connecting the RC pin to the - In. To ensure safe turn off the voltage difference between RC pin and the - In pin shall be less than 1 V. The DC/DC converter will restart automatically when this connection is opened.

Input and Output Impedance

The impedance of both the input source and the load will interact with the impedance of the DC/DC converter. It is important that the input source has low characteristic impedance. Minimum recommended external input capacitance is 220 µF. The performance in some applications can be enhanced by addition of external capacitance as described under External Decoupling Capacitors.

External Decoupling Capacitors

When powering loads with significant dynamic current requirements, the voltage regulation at the point of load can be improved by addition of decoupling capacitors at the load. The most effective technique is to locate low ESR ceramic and electrolytic capacitors as close to the load as possible, using several parallel capacitors to lower the effective ESR. The ceramic capacitors will handle high-frequency dynamic

load changes while the electrolytic capacitors are used to handle low frequency dynamic load changes. Ceramic capacitors will also reduce any high frequency noise at the load.

It is equally important to use low resistance and low inductance PCB layouts and cabling. For semi regulated DC/DC converters, such as PKB-B intermediate bus converters, there is no limit on the value of output capacitance that may be used. The user should be aware, however, that large values of capacitance will affect the ramp-up time of the DC/DC converter output voltage during start-up. For further information please contact your local Ericsson Power Modules representative.

Parallel Operation

The converters can be paralleled for redundancy if external oring diodes are used in series with the outputs.

Over Temperature Protection (OTP)

The DC/DC converters are protected from thermal overload by an internal over temperature shutdown circuit. When T_{ref} as defined in thermal consideration section exceeds 125°C the DC/DC converter will shut down. The DC/DC converter will make continuous attempts to start up (non-latching mode) and resume normal operation automatically when the temperature has dropped below the temperature threshold.

Over Voltage Protection (OVP)

The DC/DC converters have an output over voltage protection that normally will clamp the output voltage to the OVP threshold level. If the output voltage should increase to the OVP threshold level very fast then the DC/DC converter can shut down and make attempts to start up (non-latching mode). After removal of the over voltage condition the DC/DC converter will resume to normal operation automatically.

Over Current Protection (OCP)

The DC/DC converters include current limiting circuitry for protection at continuous overload. The output voltage will decrease towards zero for output currents in excess of max output current (max I_o). The DC/DC converter will resume normal operation after removal of the overload. The load distribution should be designed for the maximum output short circuit current specified.

PKB 4000B PI
Intermediate Bus Converters, Input 36-75 V, 40 A / 240 W

EN/LZT 146 384 R2A Dec 2008

© Ericsson Power Modules AB

Thermal Consideration

General

The products are designed to operate in different thermal environments and sufficient cooling must be provided to ensure reliable operation. For products mounted on a PCB without a heat sink attached cooling is achieved mainly by conduction, from the pins to the host board, and convection, which is dependant on the airflow across the product. Increased airflow enhances the cooling of the converter.

The Output Current Derating graph found in the Output section for each model provides the available output current vs. ambient air temperature and air velocity at $V_{in} = 53 V$.

The product is tested on a 254 x 254 mm, 35 μm (1 oz), 16-layer test board mounted vertically in a wind tunnel with a cross-section of 305 x 305 mm.

Proper cooling of the DC/DC converter can be verified by measuring the temperature at positions P1, P2, P3, P4 and P5. The temperature at these positions should not exceed the max values provided in the table below. The number of points may vary with different thermal design and topology.

See Design Note 019 for detailed information.

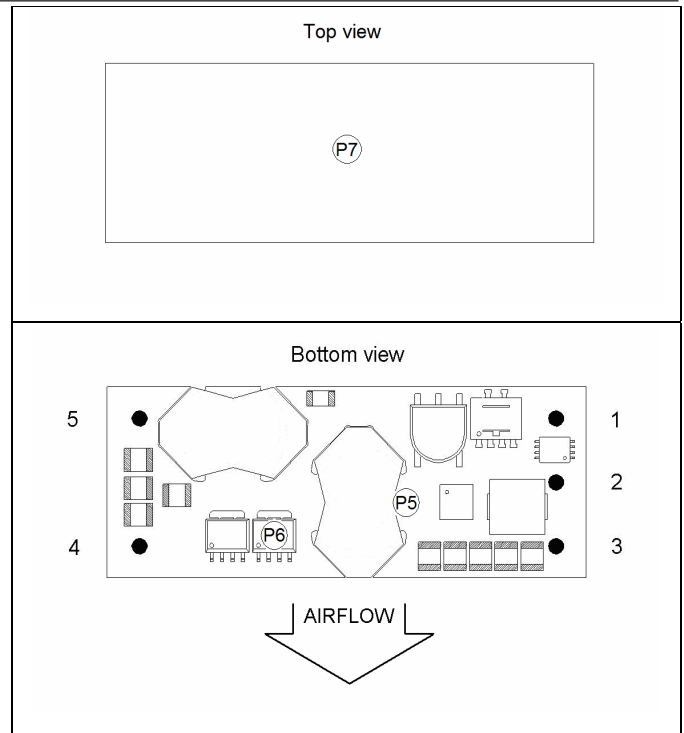

Base plate

| Position | Description | Max value |
|----------|-------------------------------|-----------|
| P1 | Reference point (T_{ref}) | 125 °C |
| P2 | Transistor | 125 °C |
| P3 | Optocoupler | 100 °C |
| P5 | Reference point (T_{ref}) | 125 °C |
| P6 | Transistor | 125 °C |
| P7 | Base plate | 105 °C |

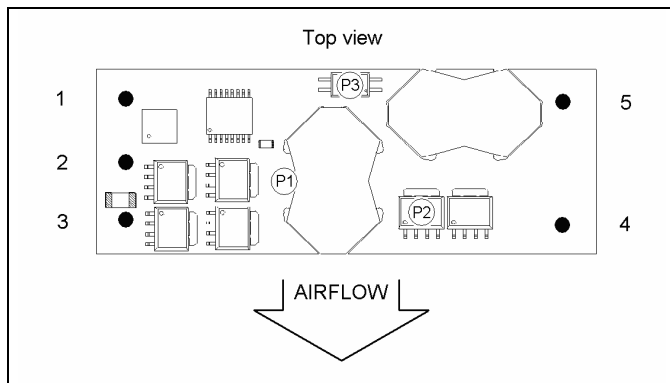

Open frame

PKB 4000B PI
Intermediate Bus Converters, Input 36-75 V, 40 A / 240 W

EN/LZT 146 384 R2A Dec 2008

© Ericsson Power Modules AB

Connections

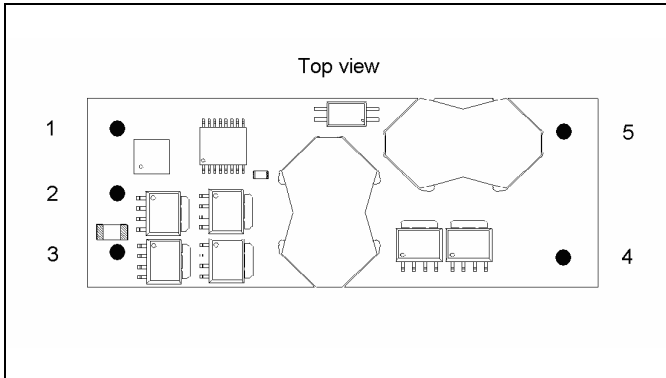

| Pin | Designation | Function |
|-----|-------------|-----------------|
| 1 | +In | Positive input |
| 2 | RC | Remote control |
| 3 | -In | Negative input |
| 4 | -Out | Negative output |
| 5 | +Out | Positive output |

PKB 4000B PI
Intermediate Bus Converters, Input 36-75 V, 40 A / 240 W

EN/LZT 146 384 R2A Dec 2008

© Ericsson Power Modules AB

Mechanical Information - Hole Mount, Open Frame Version

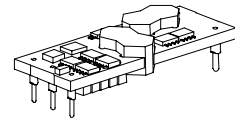
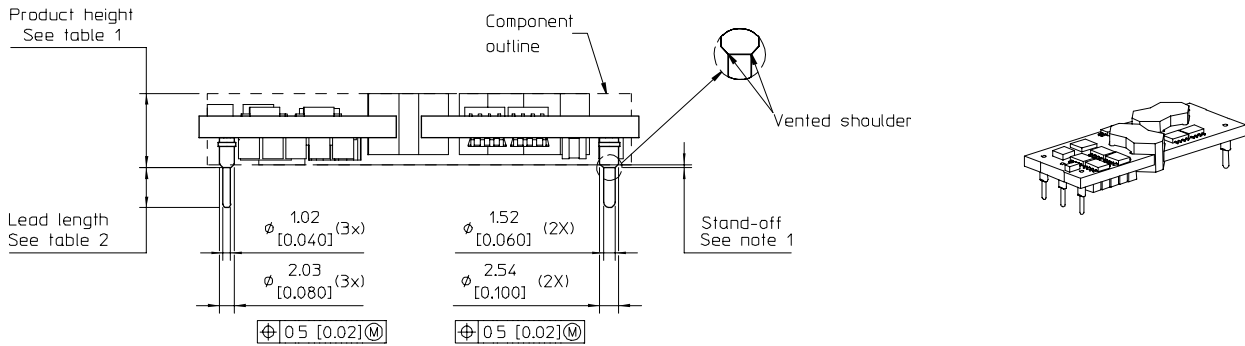

TOP VIEW
Pin positions according to recommended footprint

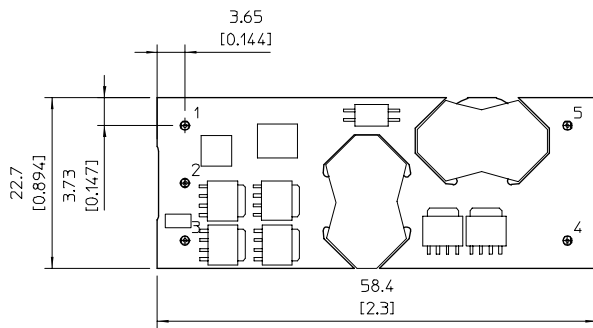

RECOMMENDED FOOTPRINT - TOP VIEW

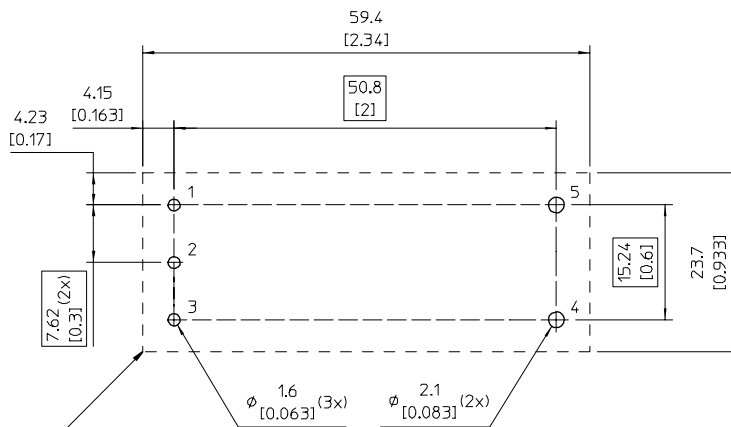

Recommended keep away area for user components

The stand-off in combination with insulating material ensures that requirements as per IEC/EN/UL60950 are met and 1500 V isolation maintained even if open vias or traces are present under the DC/DC converter.

Table 1

| Height option | Height max. |
|---------------|--------------|
| Standard | 10.1 [0.397] |
| M | 11.9 [0.468] |

Table 2

| Pin option | Lead length |
|------------|------------------|
| Standard | 5.33 [0.210] |
| LA | 3.69 [0.145] cut |
| LB | 4.57 [0.180] cut |

Notes

- 1- Stand-off to non-conductive components
min 0.1 [0.004] for Standard- option
min 1.9 [0.075] for M- option
- Stand-off to conductive components
min 0.9 [0.035] for Standard- option
min 2.7 [0.106] for M- option

Pins:

Material: Copper alloy
Plating: 0.1 μ m Gold over 2 μ m Nickel

Weight: Typical 26 g

All dimensions in mm [inch].

Tolerances unless specified

x.x \pm 0.50 [0.02], x.xx \pm 0.25 [0.01]

(not applied on footprint or typical values)



PKB 4000B PI
Intermediate Bus Converters, Input 36-75 V, 40 A / 240 W

EN/LZT 146 384 R2A Dec 2008

© Ericsson Power Modules AB

Mechanical Information - Hole Mount, Base Plate Version

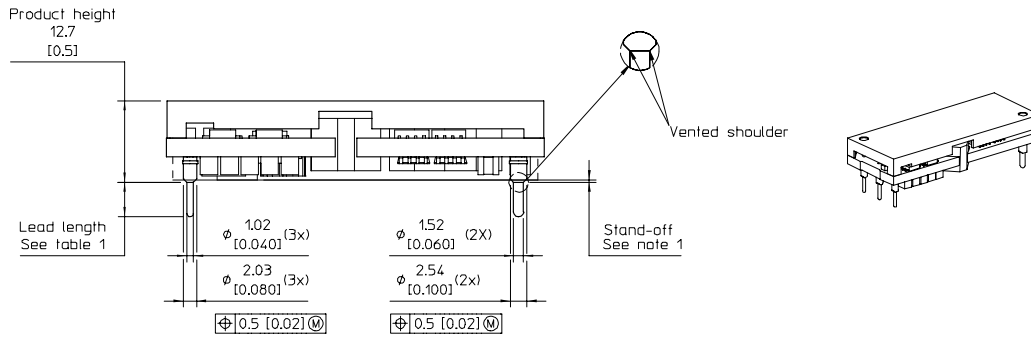

TOP VIEW
Pin positions according to recommended footprint

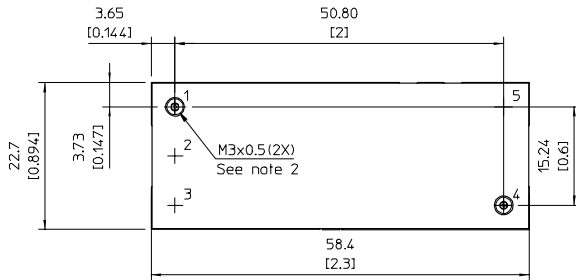

RECOMMENDED FOOTPRINT - TOP VIEW

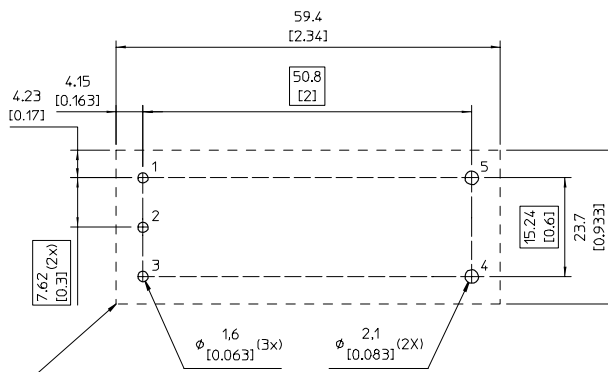

Recommended keep away area for user components
The stand-off in combination with insulating material ensures that requirements as per IEC/EN/UL60950 are met and 1500 V isolation maintained even if open vias or traces are present under the DC/DC converter.

Table 1

| Pin option | Lead length |
|------------|------------------|
| Standard | 5.33 [0.210] |
| LA | 3.69 [0.145] cut |
| LB | 4.57 [0.180] cut |

- Notes
- 1- Stand-off to non-conductive components min 0.1 [0.004]
Stand-off to conductive components min 0.9 [0.035]
 - 2- For screw attachment apply mounting torque of max 0.44 Nm [3.9 lbf in].
- M3 screws must not protrude more than 2.7 [0.106] into the base plate.

Case:
Material: Aluminium alloy
Pins:
Material: Copper alloy
Plating: 0.1 μ m Gold over 2 μ m Nickel

Weight: Typical 45 g
All dimensions in mm [inch].
Tolerances unless specified
x.x \pm 0.50 [0.02], x.xx \pm 0.25 [0.01]
(not applied on footprint or typical values)



PKB 4000B PI
Intermediate Bus Converters, Input 36-75 V, 40 A / 240 W

EN/LZT 146 384 R2A Dec 2008

© Ericsson Power Modules AB

Mechanical Information - Surface Mount Version

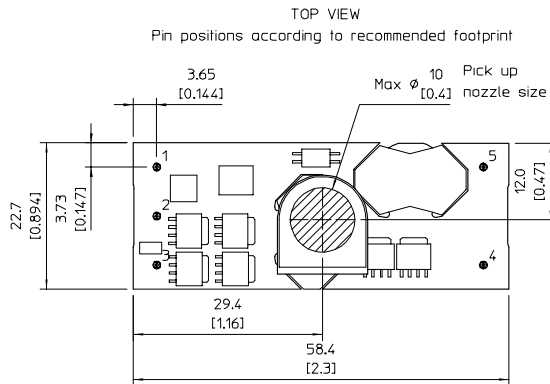
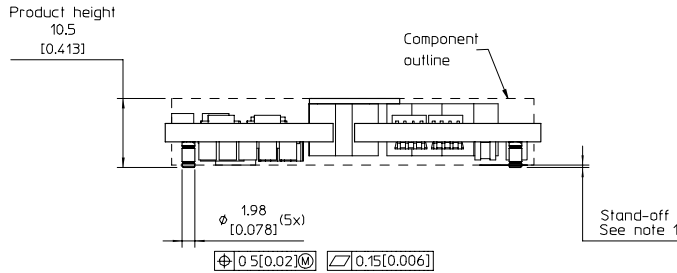

RECOMMENDED FOOTPRINT - TOP VIEW

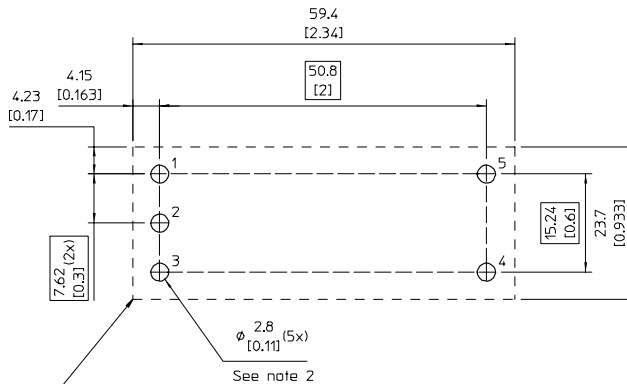

Recommended keep away area for user components

The stand-off in combination with insulating material ensures that requirements as per IEC/EN/UL60950 are met and 1500 V isolation maintained even if open vias or traces are present under the DC/DC converter.

Notes

1- Stand-off to non-conductive components
min 0.1 [0.004]

Stand-off to conductive components
min 0.9 [0.035]

2- Layout considerations

Use sufficient numbers of vias connected to output pin pads for optimal thermal and current connectivity.

Pins:

Material: Copper alloy

Plating: 0.1 μ m Gold over 2 μ m Nickel

Weight: Typical 26 g

All dimensions in mm [inch].

Tolerances unless specified

x.x \pm 0.50 [0.02], x.xx \pm 0.25 [0.01]

(not applied on footprint or typical values)



PKB 4000B PI

Intermediate Bus Converters, Input 36-75 V, 40 A / 240 W

EN/LZT 146 384 R2A Dec 2008

© Ericsson Power Modules AB

Soldering Information - Surface Mounting

The surface mount product is intended for forced convection or vapor phase reflow soldering in SnPb and Pb-free processes.

The reflow profile should be optimised to avoid excessive heating of the product. It is recommended to have a sufficiently extended preheat time to ensure an even temperature across the host PCB and it is also recommended to minimize the time in reflow.

A no-clean flux is recommended to avoid entrapment of cleaning fluids in cavities inside the product or between the product and the host board, since cleaning residues may affect long time reliability and isolation voltage.

Minimum Pin Temperature Recommendations

Pin number 4 is chosen as reference location for the minimum pin temperature recommendation since this will likely be the coolest solder joint during the reflow process.

SnPb solder processes

For SnPb solder processes, a pin temperature (T_{PIN}) in excess of the solder melting temperature, (T_L , 183°C for Sn63Pb37) for more than 30 seconds and a peak temperature of 210°C is recommended to ensure a reliable solder joint.

For dry packed products only: depending on the type of solder paste and flux system used on the host board, up to a recommended maximum temperature of 245°C could be used, if the products are kept in a controlled environment (dry pack handling and storage) prior to assembly.

| General reflow process specifications | | SnPb eutectic | Pb-free |
|---|---------------|---------------|-----------|
| Average ramp-up ($T_{PRODUCT}$) | | 3°C/s max | 3°C/s max |
| Typical solder melting (liquidus) temperature | T_L | 183°C | 221°C |
| Minimum reflow time above T_L | | 30 s | 30 s |
| Minimum pin temperature | T_{PIN} | 210°C | 235°C |
| Peak product temperature | $T_{PRODUCT}$ | 225°C | 260°C |
| Average ramp-down ($T_{PRODUCT}$) | | 6°C/s max | 6°C/s max |
| Maximum time 25°C to peak | | 6 minutes | 8 minutes |

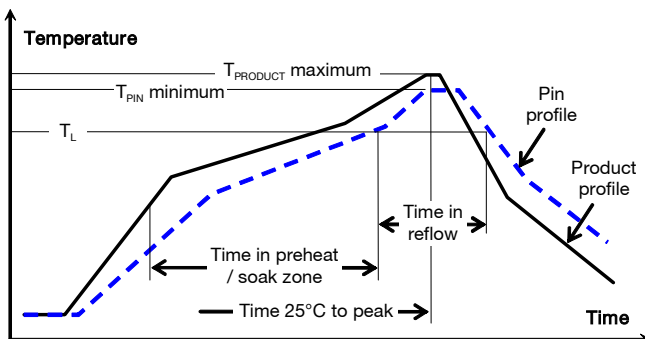

Lead-free (Pb-free) solder processes

For Pb-free solder processes, a pin temperature (T_{PIN}) in excess of the solder melting temperature (T_L , 217 to 221°C for SnAgCu solder alloys) for more than 30 seconds and a peak temperature of 235°C on all solder joints is recommended to ensure a reliable solder joint.

Maximum Product Temperature Requirements

Top of the product PCB near pin 2 is chosen as reference location for the maximum (peak) allowed product temperature ($T_{PRODUCT}$) since this will likely be the warmest part of the product during the reflow process.

SnPb solder processes

For SnPb solder processes, the product is qualified for MSL 1 according to IPC/JEDEC standard J-STD-020C.

During reflow $T_{PRODUCT}$ must not exceed 225 °C at any time.

Pb-free solder processes

For Pb-free solder processes, the product is qualified for MSL 3 according to IPC/JEDEC standard J-STD-020C.

During reflow $T_{PRODUCT}$ must not exceed 260 °C at any time.

Dry Pack Information

Products intended for Pb-free reflow soldering processes are delivered in standard moisture barrier bags according to IPC/JEDEC standard J-STD-033 (Handling, packing, shipping and use of moisture/reflow sensitivity surface mount devices).

Using products in high temperature Pb-free soldering processes requires dry pack storage and handling. In case the products have been stored in an uncontrolled environment and no longer can be considered dry, the modules must be baked according to J-STD-033.

Thermocouple Attachment

Top of PCB near pin 2 for measurement of maximum product temperature, $T_{PRODUCT}$

TOP VIEW

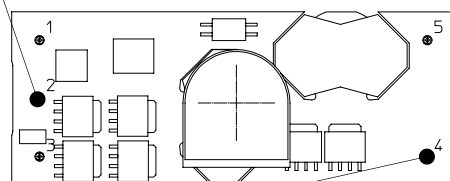

Pin 4 for measurement of minimum pin (solder joint) temperature, T_{PIN}

PKB 4000B PI
Intermediate Bus Converters, Input 36-75 V, 40 A / 240 W

EN/LZT 146 384 R2A Dec 2008

© Ericsson Power Modules AB

Soldering Information - Hole Mounting

The hole mounted product is intended for plated through hole mounting by wave or manual soldering. The pin temperature is specified to maximum to 270°C for maximum 10 seconds.

A maximum preheat rate of 4°C/s and maximum preheat temperature of 150°C is suggested. When soldering by hand, care should be taken to avoid direct contact between the hot soldering iron tip and the pins for more than a few seconds in order to prevent overheating.

A no-clean flux is recommended to avoid entrapment of cleaning fluids in cavities inside the product or between the product and the host board. The cleaning residues may affect long time reliability and isolation voltage.

Delivery Package Information

Surface Mount Version

The products are delivered in antistatic injection molded trays (Jedec design guide 4.10D standard).

| Tray Specifications | |
|---------------------------|--|
| Material | Antistatic PPE |
| Surface resistance | $10^5 < \text{Ohm/square} < 10^{12}$ |
| Bakability | The trays can be baked at maximum 125°C for 48 hours |
| Tray thickness | 17.4 mm [0.685 inch] |
| Box capacity | 100 products (5 full trays/box) |
| Tray weight | 120 g empty, 640 g full tray |

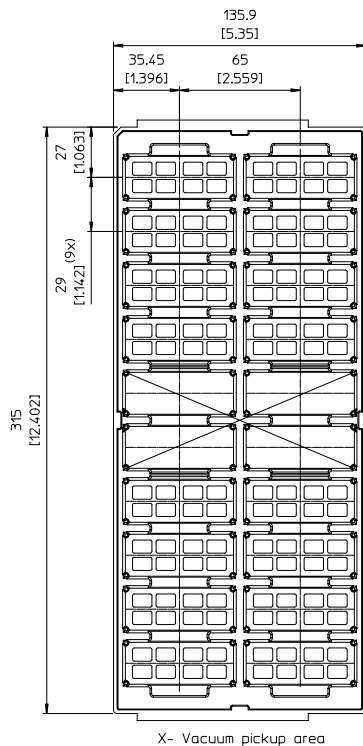

Delivery Package Information

Hole Mount, Open Frame version

Hole Mount, Base Plate version

The products are delivered in antistatic trays.

| Tray Specifications | |
|---------------------------|---|
| Material | PE Foam |
| Surface resistance | $10^5 < \text{Ohm/square} < 10^{12}$ |
| Bakability | The trays are not bakeable |
| Tray thickness | 22 mm [0.87 inch] |
| Box capacity | 75 products (3 full trays/box) |
| Tray weight | Open frame version 40 g empty, 690 g full tray Base plate version 40 g empty, 1165 g full tray |

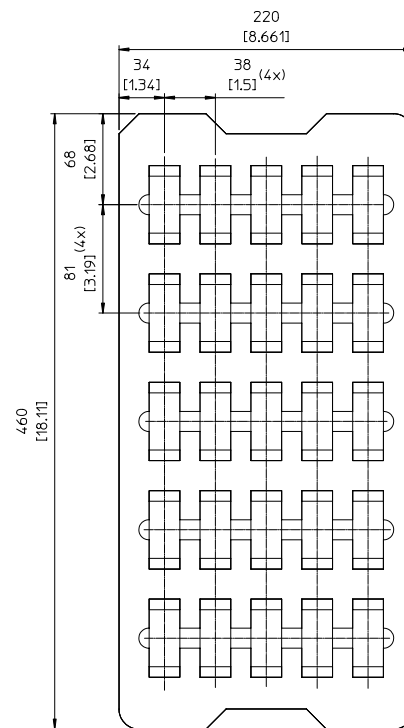

| | |
|--|-----------------------------|
| PKB 4000B PI Intermediate Bus Converters, Input 36-75 V, 40 A / 240 V | EN/LZT 146 384 R2A Dec 2008 |
| | © Ericsson Power Modules AB |

Product Qualification Specification

| Characteristics | | | |
|---|--|---|---|
| External visual inspection | IPC-A-610 | | |
| Change of temperature (Temperature cycling) | IEC 60068-2-14 Na | Temperature range Number of cycles Dwell/transfer time | -40 to 100°C 1000 15 min/0-1 min |
| Cold (in operation) | IEC 60068-2-1 Ad | Temperature T _A Duration | -45°C 72 h |
| Damp heat | IEC 60068-2-67 Cy | Temperature Humidity Duration | 85°C 85 % RH 1000 hours |
| Dry heat | IEC 60068-2-2 Bd | Temperature Duration | 125°C 1000 h |
| Electrostatic discharge susceptibility | IEC 61340-3-1, JESD 22-A114 IEC 61340-3-2, JESD 22-A115 | Human body model (HBM) Machine Model (MM) | Class 2, 2000 V Class 3, 200 V |
| Immersion in cleaning solvents | IEC 60068-2-45 XA, method 2 | Water Glycol ether Isopropyl alcohol | 55°C 35°C 35°C |
| Mechanical shock | IEC 60068-2-27 Ea | Peak acceleration Duration | 100 g 6 ms |
| Moisture reflow sensitivity ¹ | J-STD-020C | Level 1 (SnPb-eutectic) Level 3 (Pb Free) | 225°C 260°C |
| Operational life test | MIL-STD-202G, method 108A | Duration | 1000 h |
| Resistance to soldering heat ² | IEC 60068-2-20 Tb, method 1A | Solder temperature Duration | 270°C 10-13 s |
| Robustness of terminations | IEC 60068-2-21 Test Ua1 IEC 60068-2-21 Test Ue1 | Through hole mount products Surface mount products | All leads All leads |
| Solderability | IEC 60068-2-58 test Td ¹ | Preconditioning Temperature, SnPb Eutectic Temperature, Pb-free | 150°C dry bake 16 h 215°C 235°C |
| | IEC 60068-2-20 test Ta ² | Preconditioning Temperature, SnPb Eutectic Temperature, Pb-free | Steam ageing 235°C 245°C |
| Vibration, broad band random | IEC 60068-2-64 Fh, method 1 | Frequency Spectral density Duration | 10 to 500 Hz 0.07 g ² /Hz 10 min in each direction |

Notes
¹ Only for products intended for reflow soldering (surface mount products)

² Only for products intended for wave soldering (plated through hole products)