



Technical Reference Notes
ALQ40/50 Series
(Open Frame Single Output Quarter Brick)



ALQ50 Single Output Open-Frame DC-DC Converter Module
Industry Standard ¼ Brick: 36V-75V Input / 50A Output Current

PRELIMINARY

The ALQ50 series is Astec's next generation single output, high-density standard quarter brick offering. It operates from a 36V to 75V DC Bus and comes in different Isolated Logic Output voltages (ILO) well suited for DPA applications. It's designed to conservatively handle 50A of output current for 2.5V and below at high levels of efficiency (3.3V @ 90.5%). It provides tight regulation and exhibits clean and monotonic output start up characteristics. The ALQ50's come with industry standard features such as Input UVLO, OCP, OVP, OTP, Output Trim, differential output Sense pins. With its 0.36" low profile and open frame construction, it offers optimum board mounting flexibility.



Special Features

- Industry Standard ¼ Brick Footprint
- Positive and Negative Enable Options
- Regulation to Zero Load
- High Capacitive Load Start-up
- Fixed Switching Frequency at 480kHz
- Output Trim
- Input Under-Voltage Lockout
- Low profile / open-frame

Environmental Specifications

- -40°C to 85°C Operating Temperature
- -40°C to 125°C Storage Temperature
- MTBF > 1 million hours

Electrical Parameters

Input

Input Range	36-75 VDC
Input Surge	100V / 100ms
Efficiency	3.3V @ 90.5% (Typ)
	2.5V @ 90.0%
	1.8V @ 89.0%
	1.2V @ 86.5%

Control

Enable	TTL compatible
(Positive and Negative Enable Options)	

Output

Load Current	2.5V @ 50A max
Line/Load Regulation	< 1% V _O
Ripple and Noise	60mV _{PK-PK} max
Output Voltage	
Adjust Range	±10% V _O
Transient Response	5% V _O deviation (Typ)
	50% to 75% Load Change
	250msec settling time (Typ)
Remote Sense	+10% V _O
Over Current	
Protection	120% I _{O,MAX}

Safety

UL + cUL 60950, Recognized (Pending)
EN60950 through TUV-PS (Pending)



Technical Reference Notes
ALQ40/50 Series
(Open Frame Single Output Quarter Brick)



ALQ50 Series

THIS SPECIFICATION COVERS THE REQUIREMENTS FOR A NEW ¼-BRICK SIZE
50A SINGLE OUTPUT HIGH EFFICIENCY DC/DC CONVERTER.

MODEL NAME	CONSTRUCTION	V _{OUT} / I _{OUT}
ALQ40F48	Open Frame; Low Profile	3.3V / 40A
ALQ50G48	Open Frame; Low Profile	2.5V / 50A
ALQ50Y48	Open Frame; Low Profile	1.8V / 50A
ALQ50K48	Open Frame; Low Profile	1.2V / 50A

OPTIONS:

Negative Enable:	<u>SUFFIX</u> "N"
Positive Enable:	No suffix



Technical Reference Notes
ALQ40/50 Series
(Open Frame Single Output Quarter Brick)



Electrical Specifications

STANDARD TEST CONDITION on a single module unless otherwise specified.

T _A		25°C (Ambient Air)
Airflow		Refer to Figures 21 to 24
+V _{IN}	PIN 1	Return pin for +V _{IN}
Enable	PIN 2	Dependent on model series
-V _{IN}	PIN 3	48V ± 2V
-V _{OUT}	PIN 4	Connected to Load
-Sense	PIN 5	Connected to +V _{OUT}
Trim	PIN 6	Open
+Sense	PIN 7	Connected to -V _{OUT}
+V _{out}	PIN 8	Connected to Load (return)

ABSOLUTE MAXIMUM RATINGS

Stresses in excess of the absolute maximum ratings can cause permanent damage to the converter. Functional operation of the device is converter is not implied at these or any other conditions in excess of those given in the operational section of the specs. Exposure to absolute maximum ratings for extended period can adversely affect device reliability.

Parameter	Device	Symbol	Min	Typ	Max	Unit
Input Voltage ¹	All	V _{IN}	0	-	75	Vdc
	All	V _{IN,trans}	0	-	100	Vdc
Isolation Voltage Input to Output	All		1500	-	-	Vdc
Operating Ambient Temperature	All	T _A	-40	-	+85	°C
Storage Temperature	All	T _{STG}	-40	-	125	°C
Operating Humidity	All	-	-	-	85	%
Maximum Enable Voltage	All				25	Vdc
Max Output Power	F (3.3V)	P _O	-	-	132	W
	G (2.5V)	P _O	-	-	125	W
	Y (1.8V)	P _O	-	-	90	W
	K (1.2V)	P _O	-	-	60	W



Technical Reference Notes
ALQ40/50 Series
(Open Frame Single Output Quarter Brick)



Electrical Specifications (continued)

INPUT SPECIFICATION

Parameter	Device	Symbol	Min	Typ	Max	Unit
Operating Input Voltage	All	V_{IN}	36	48	75	V_{DC}
Input Under-Voltage Lock-out	All					Vdc
T_ON Threshold			33	-	35	
T_OFF Threshold			32	-	34	
Maximum Input Current ¹	F (3.3V)	$I_{IN,max}$	-	-	4.4	A
Conditions: $V_{IN} = V_{IN,min}$	G (2.5V)		-	-	4.3	
$I_O = I_{O,max}; T_A = 25\text{ }^\circ\text{C}$	Y (1.8V)		-	-	3.2	
	K (1.2V)		-	-	2.3	
Max P_{DISS} @ $I_O = 0A$ ($V_{IN} = V_{IN,NOM}$)	3V3 (F)		-	-	5	W
	2V5 (G)		-	-	5	
	1V8 (Y)		-	-	3.3	
	1V2 (K)		-	-	2.5	
Input Reflected Ripple Current ²	All	I_{I1}/I_{I2}	-	-	10	mA_{PK-PK}
Conditions: $P_O = P_{O,max}; T_A = 25\text{ }^\circ\text{C}$						
BW: 5Hz to 20MHz						

- Note: 1. An input line fuse is recommended for use.
2. External input capacitance required. See Input Ripple Current test measurement setup on Fig 1.

OUTPUT SPECIFICATIONS

Parameter	Device	Symbol	Min	Typ	Max	Unit
Output Voltage Set point	3V3 (F)	$V_{O,SET}$	3.260	3.300	3.340	Vdc
$V_{IN} = V_{IN,min}$ to $V_{IN,max}$;	2V5 (G)		2.465	2.500	2.535	Vdc
$I_O = I_{O,Max}$	1V8 (Y)		1.770	1.800	1.830	Vdc
	1V2 (K)		1.180	1.200	1.220	Vdc
Output Regulation						%Vo
Line: $V_{IN} = V_{IN,Min}$ to $V_{IN,Max}$	All	-	-	-	± 0.20	
	1V2 (K)				± 0.30	
Load: $I_O = I_{O,Min}$ to $I_{O,Max}$	All	-	-	-	± 0.20	
	1V2 (K)				± 0.30	
Temperature: $T_a = -40\text{ }^\circ\text{C}$ to $+85\text{ }^\circ\text{C}$	All	-	-	-	± 1.00	
Ripple and Noise ⁴	1V2	-	-	25	50	mVp-p
Peak-to-Peak: (5Hz to 20MHz)	1V8/2V5	-	-	35	75	mVp-p
	3V3			45	100	mVp-p
Output Current ³	3V3	I_O	0	-	40	A
	All		0	-	50	
External Load Capacitance	All	-	-	-	25,000	μF
Capacitor ESR			4	-	-	$\text{m}\Omega$
Output Current-limit Inception	3V3	I_O	41	-	52	A
$V_{OUT} = 90\% V_{O,SET}$ ⁵	All		52	-	68	



Technical Reference Notes
ALQ40/50 Series
(Open Frame Single Output Quarter Brick)



Electrical Specifications *(continued)*

OUTPUT SPECIFICATIONS

Parameter	Device	Symbol	Min	Typ	Max	Unit
Over Voltage Protection Range ⁷	3V3 (F) 2V5 (G) 1V8 (Y) 1V2 (K)		3.9 3.0 2.0 1.4	4.1 3.2 2.4 1.6	4.9 3.9 2.9 2.1	v
Over Temperature Range ⁶ (AVG PCB TEMPERATURE)	All		110	-	120	°C
Efficiency $V_{IN} = V_{IN-NOM}; I_O = I_{O,MAX}$ $T_A = 25^\circ C$	3V3 (F) 2V5 (G) 1V8 (Y) 1V2 (K)	η η η η	89.5 89.0 88.0 85.5	90.5 90.0 89.0 86.5	- - - -	% % % %
Turn-On Response Time $V_{IN} = V_{IN-MIN}$ to V_{IN-MAX}	All	-	-	-	15	ms
Switching Frequency	All 2V5	- -	440 490	480 540	520 590	KHz KHz
Dynamic Response: $\Delta I_O / \Delta t = 0.1A / \mu S$ $C_O = 0\mu F$		-	-	0.1	-	A/ μs
Load Change from $I_O = 50\%$ to 75% of $I_{O, Max}$: Peak Deviation Settling Time to $V_{O, Nom}$	1V2/1V8 2V5/3V3 All	- - -	- - -	100 125 250	140 165 500	mV μs
Load Change from $I_O = 50\%$ to 25% of $I_{O, Max}$: Peak Deviation Settling Time to $V_{O, Nom}$	1V2/1V8 2V5/3V3 All	- - -	- - -	100 115 250	140 150 500	mV μs
Output Overshoot at T-on / T-off Passive Resistive Full Load	All	-	-	-	5	% V_O

- Note:
3. Appropriate Thermal Derating applies. See Appendix B for the Thermal Derating Curves
 4. See Figure 2 for Ripple and Noise test measurement setup.
 5. In an event of an over current condition - the converter will be latched off. Restart is possible either by cycling the input voltage or toggling the Enable signal for 100ms. Consult factory for Auto restart option.
 6. Output of the module will be terminated once the operating temp reaches the OTP range. Normal operation resumes once the temperature falls below the OTP range.
 7. The OVP mode is latching. The converter will be latched off once the sensed voltage across the output pins exceeds the threshold limits. Restart is possible by either cycling the input voltage or toggling the Enable signal for 100ms.



Technical Reference Notes
ALQ40/50 Series
(Open Frame Single Output Quarter Brick)



Electrical Specifications (continued)

FEATURE SPECIFICATION

Parameter	Device	Symbol	Min	Typ	Max	Unit
Output Enable ON/OFF ¹⁰						
Negative Enable ("N" suffix)	N	-	0	-	1.2	V
Enable Pin voltage for Module ON	suffix	-	2.95	-	20.0	V
Module OFF						
Positive Enable (No suffix)	No	-	2.95	-	20.0	V
Enable Pin voltage for Module ON	suffix	-	0	-	1.2	V
Module OFF						
Output Voltage Remote Sensing ^{11,13}	All	-	-	-	10	%V _O
Output Voltage Trim Range ^{12,13}	All		90		110	%V _O

- Note:
10. See Appendix A.3 for the recommended/ appropriate Module Enable configuration.
 11. The sense pins can be used to compensate for any voltage drops (per indicated max limits) that may occur along the connection between the output pins to the load. Pin 7 (+Sense) and Pin 5 (-Sense) should be connected to Pin 8 (+Vout) and Pin 4 (Return) respectively at the point where regulation is desired.
 12. Refer to Equation (1) and (2) and Figures 3 and 4 for the Output Trim Adjust configuration.
 13. The combination of remote sense and Trim adjust cannot exceed 110% of V_{O,NOM}.

ISOLATION SPECIFICATION

Parameter	Device	Symbol	Min	Typ	Max	Unit
Isolation Capacitance	All	-	-	2.70	-	nF
Isolation Resistance	All	-	10	-	-	MΩ

SAFETY APPROVAL

The ALQ50 series have been certified through:

- UL + cUL 60950, Third Edition - Recognized (PENDING)
- EN 60950 through TUV-PS (PENDING)
- Basic Insulation

Electrical Specifications *(continued)*

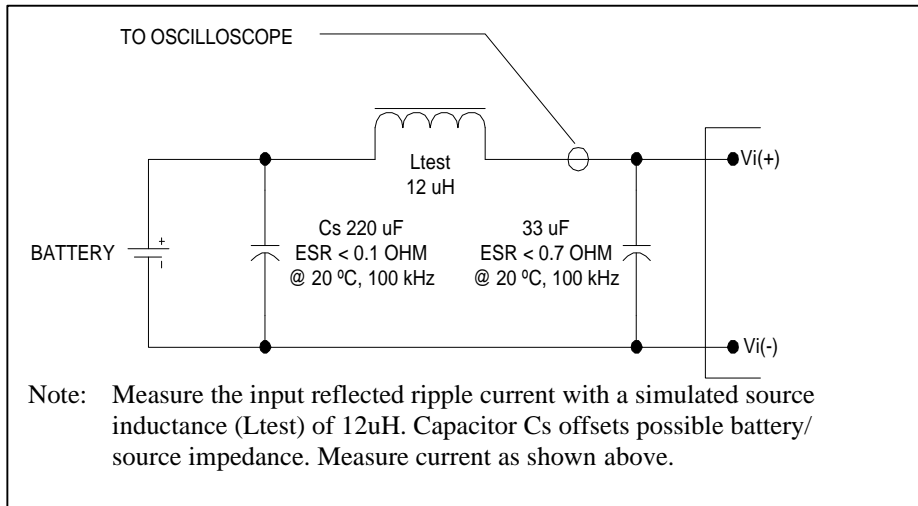

Figure 1. Input Reflected Ripple Current Measurement Setup.

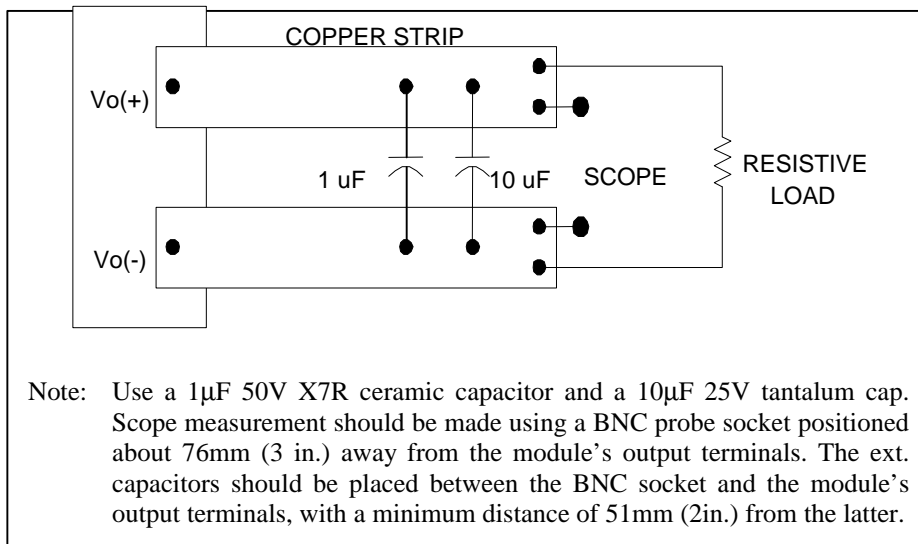

Figure 2. Peak to Peak Output Noise Measurement Setup.

Basic Operation and Features

INPUT UNDER VOLTAGE LOCKOUT

To prevent any instability to the converter, which may affect the end system, the ALQ50 series have been designed to turn-on once V_{IN} is in the voltage range of 33-35 VDC. Likewise, it has also been programmed to turn-off when V_{IN} drops down to 32-34 VDC.

OUTPUT VOLTAGE ADJUST/TRIM

The converter comes with a TRIM pin (PIN 6), which is used to adjust the output by as much as 90% to 110% of its set point. This is achieved by connecting an external resistor as described below.

To **INCREASE** the output, external R_{adj_up} resistor should be connected between TRIM PIN (Pin6) and +SENSE PIN (Pin 7). Please refer to Equation (1) for the required external resistance and output adjust relationship.

3.3V/2.5V/1.8V

Equation (1a):

$$R_{adj_up} = \left(\frac{5.1 \cdot V_o(100 + \Delta\%)}{1.225 \Delta\%} - \frac{510}{\Delta\%} - 10.2 \right) \cdot k\Omega$$

1.2V

Equation (1b):

$$R_{adj_up} = \left(\frac{5.1 \cdot V_o(100 + \Delta\%)}{0.6 \Delta\%} - \frac{510}{\Delta\%} - 10.2 \right) \cdot k\Omega$$

To **DECREASE** the output, external R_{adj_down} resistor should be connected between TRIM PIN (Pin 6) and -SENSE PIN (Pin 5). Please refer to Equation (2) for the required external resistance and output adjust relationship.

Equation (2)

$$R_{adj_down} = \left(\frac{510}{\Delta\%} - 10.2 \right) \cdot k\Omega$$

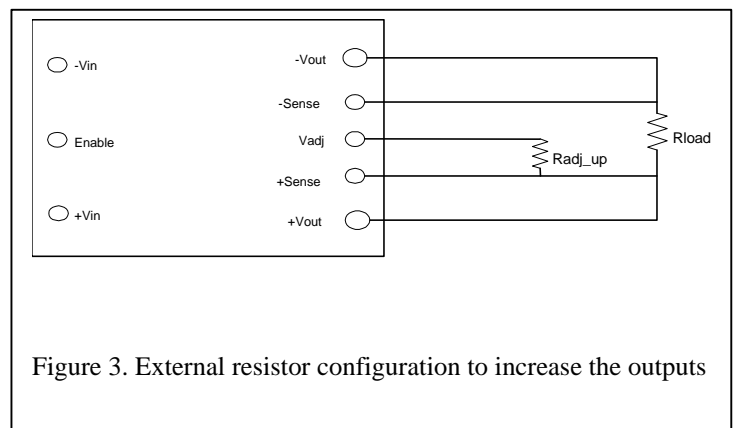

Figure 3. External resistor configuration to increase the outputs

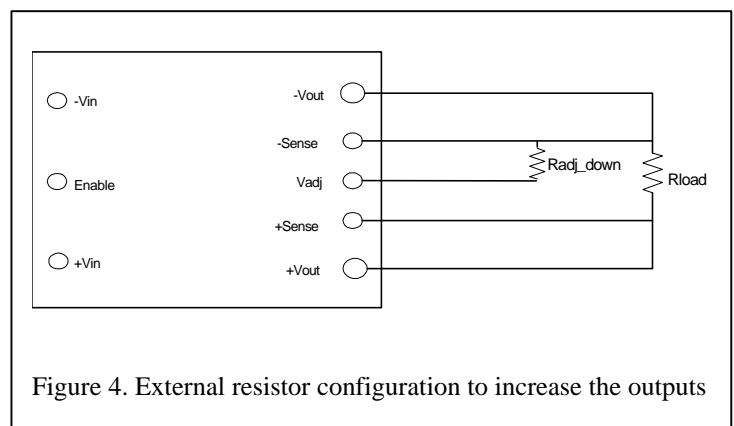

Figure 4. External resistor configuration to decrease the outputs



Technical Reference Notes
ALQ40/50 Series
(Open Frame Single Output Quarter Brick)



Basic Operation and Features *(continued)*

OUTPUT ENABLE

The ALQ50 series comes with an Enable pin (PIN 2), which is primarily used to turn ON/OFF the converter. Both a Positive (no part number suffix required) and a Negative (suffix "N" required) Enable Logic options are being offered. Please refer to Table 2 for the Part Numbering Scheme.

For Positive Enable, the converter is turned on when the Enable pin is at logic HIGH or left open. The unit turns off when the Enable pin is at logic LOW or directly connected to $-V_{IN}$. On the other hand, the Negative Enable version turns unit on when the Enable pin is at logic LOW or directly connected to $-V_{IN}$. The unit turns off when the Enable pin is at Logic HIGH.

OUTPUT OVER VOLTAGE PROTECTION (OVP)

The Over Voltage Protection circuit comes in latching mode. The converter is latched off if the output voltage exceeds the OVP threshold limits. The OVP latch is reset either by cycling the input voltage or toggling the Enable signal for 100ms.

OVER CURRENT PROTECTION (OCP)

The Over Current Protection circuit comes in latching mode. The converter is latched off if the load current on the output reaches the OCP threshold limit. The OCP latch can be reset either by cycling the input voltage or toggling the Enable signal for 100ms. Consult factory for Auto-restart option.

OVER TEMPERATURE PROTECTION (OTP)

The Over Temperature Protection circuit will shutdown the converter once the average PCB temperature reaches the OTP range. This feature prevents the unit from overheating and consequently going into thermal runaway, which may further damage the converter and the end system. Such overheating may be an effect of operation outside the given power thermal derating conditions. Restart is possible once the temperature of the sensed location drops to less than 110°C.



Technical Reference Notes
ALQ40/50 Series
(Open Frame Single Output Quarter Brick)



Performance Curves

ALQ40F48 (3.3V) SERIES

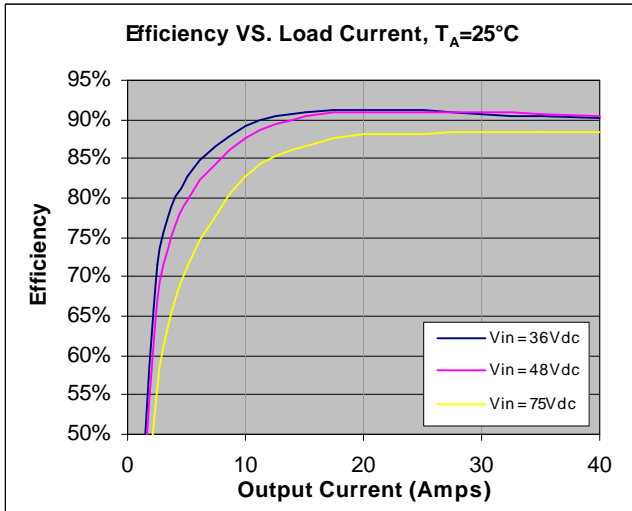

Figure 5. Efficiency vs. Load Current Curves at $T_A=25^\circ\text{C}$ for different input voltages with 300 LFM airflow directed from Pins 3 to 1.

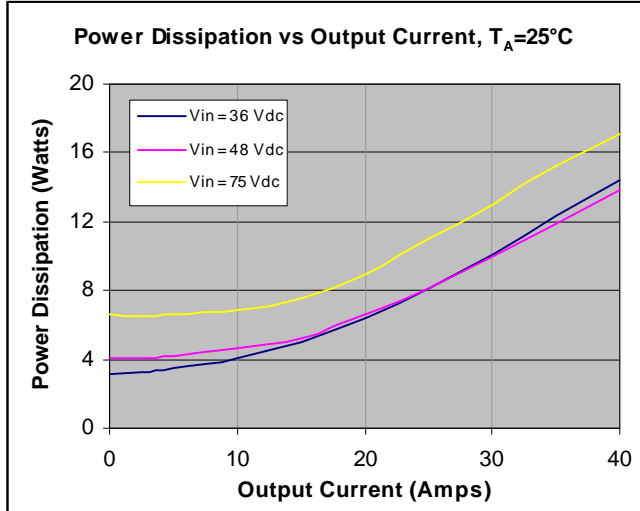

Figure 6. Power Dissipation vs. Load Current at $T_A=25^\circ\text{C}$ for different input voltages with 300 LFM airflow directed from Pins 3 to 1.

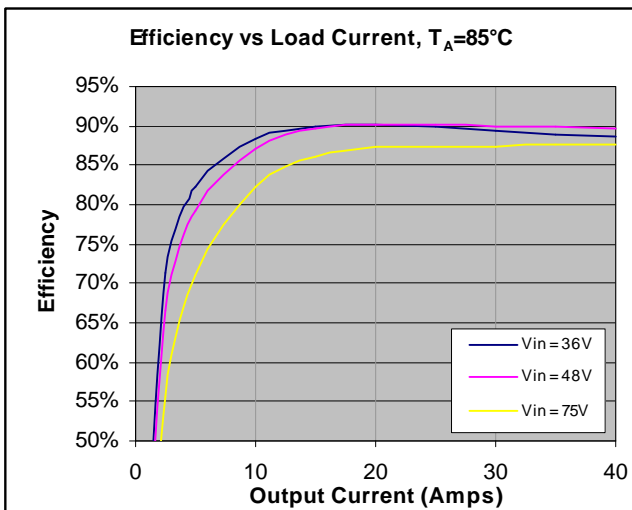

Figure 7. Efficiency vs. Load Current Curves at $T_A=85^\circ\text{C}$ for different input voltages with 300 LFM airflow directed from Pins 3 to 1.

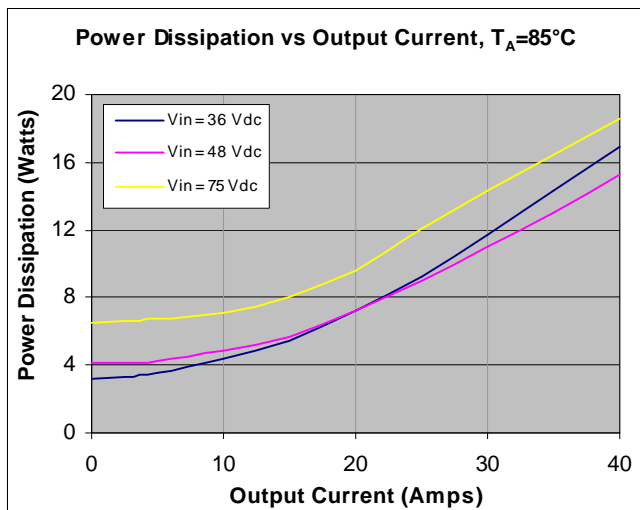

Figure 8. Power Dissipation vs. Load Current at $T_A=85^\circ\text{C}$ for different input voltages with 300 LFM airflow directed from Pins 3 to 1.



Technical Reference Notes
ALQ40/50 Series
(Open Frame Single Output Quarter Brick)



Performance Curves (continued)

ALQ50G48 (2.5V) SERIES

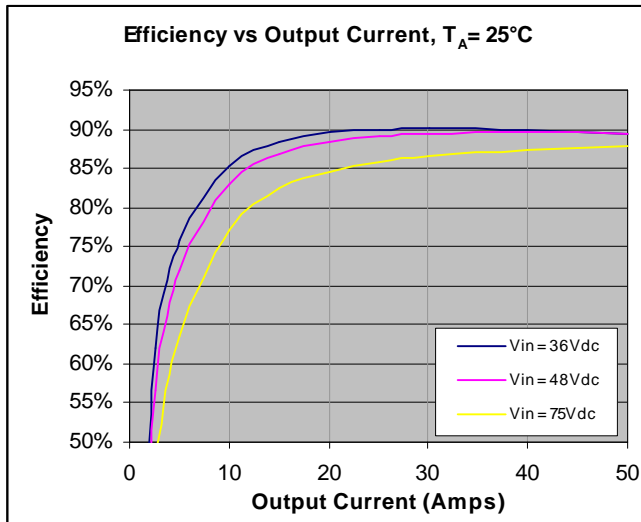

Figure 9. Efficiency vs. Load Current Curves at $T_A=25^{\circ}\text{C}$ for different input voltages with 300 LFM airflow directed from Pins 3 to 1.

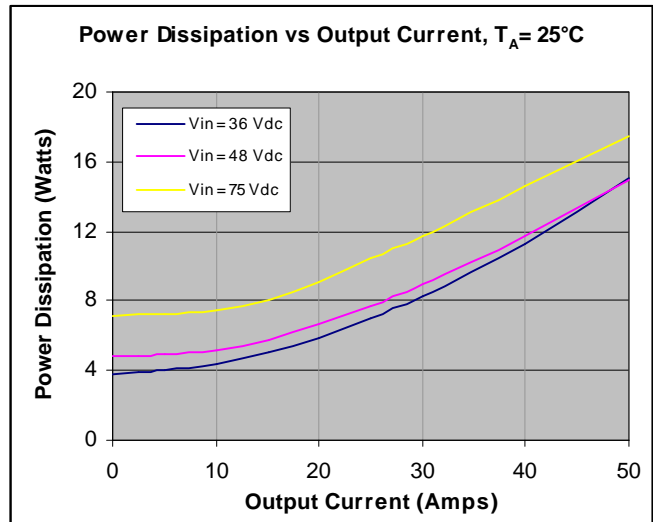

Figure 10. Power Dissipation vs. Load Current at $T_A=25^{\circ}\text{C}$ for different input voltages with 300 LFM airflow directed from Pins 3 to 1.

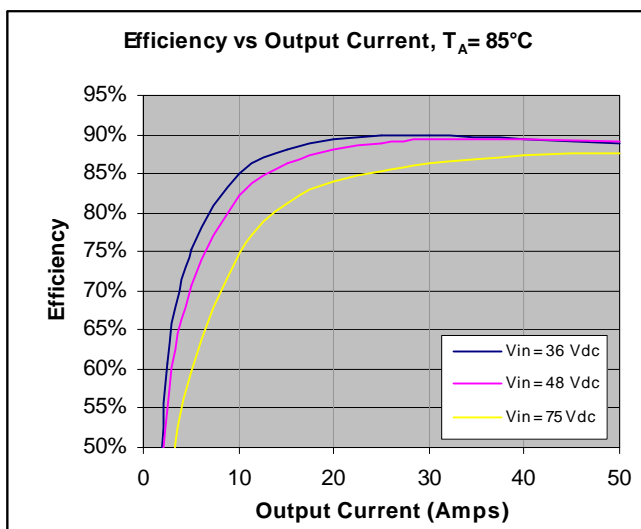

Figure 11. Efficiency vs. Load Current Curves at $T_A=85^{\circ}\text{C}$ for different input voltages with 300 LFM airflow directed from Pins 3 to 1.

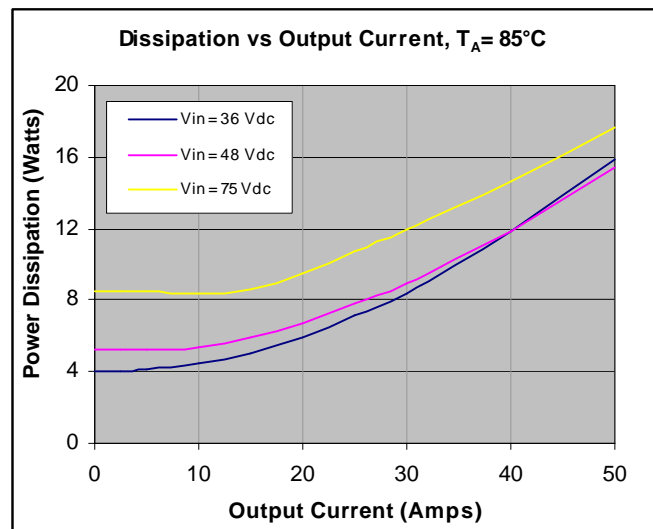

Figure 12. Power Dissipation vs. Load Current at $T_A=85^{\circ}\text{C}$ for different input voltages with 300 LFM airflow directed from Pins 3 to 1.



Technical Reference Notes
ALQ40/50 Series
(Open Frame Single Output Quarter Brick)



Performance Curves (continued)

ALQ50Y48 (1.8V) SERIES

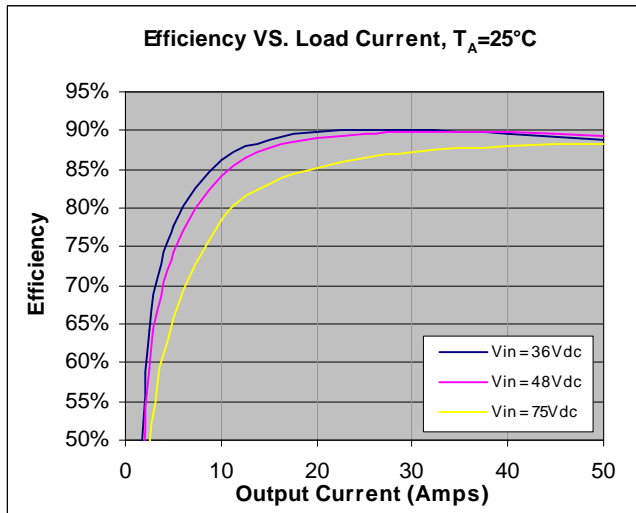

Figure 13. Efficiency vs. Load Current Curves at $T_A=25^\circ\text{C}$ for different input voltages with 300 LFM airflow directed from Pins 3 to 1.

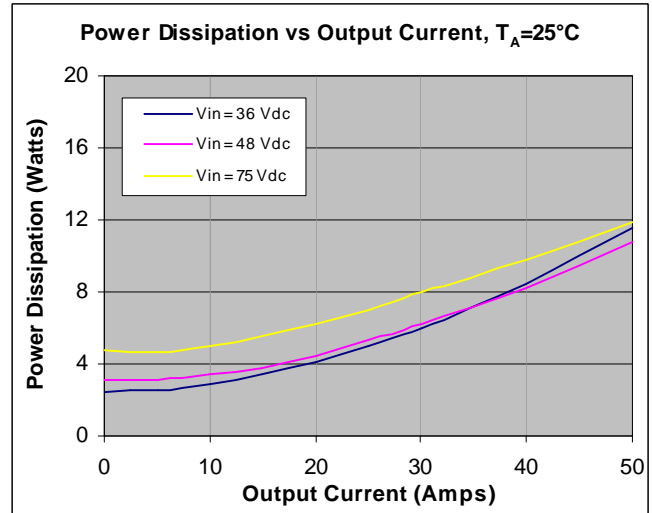

Figure 14. Power Dissipation vs. Load Current at $T_A=25^\circ\text{C}$ for different input voltages with 300 LFM airflow directed from Pins 3 to 1.

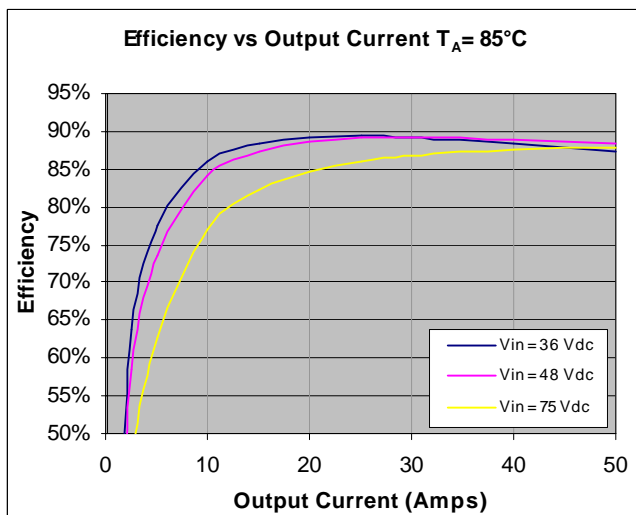

Figure 15. Efficiency vs. Load Current Curves at $T_A=85^\circ\text{C}$ for different input voltages with 300 LFM airflow directed from Pins 3 to 1.

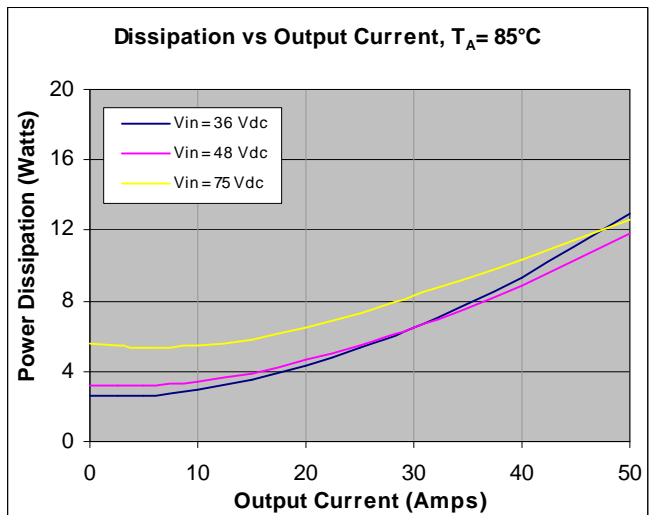

Figure 16. Power Dissipation vs. Load Current at $T_A=85^\circ\text{C}$ for different input voltages with 300 LFM airflow directed from Pins 3 to 1.



Technical Reference Notes
ALQ40/50 Series
(Open Frame Single Output Quarter Brick)



Performance Curves (continued)

ALQ50K48 (1.2V) SERIES

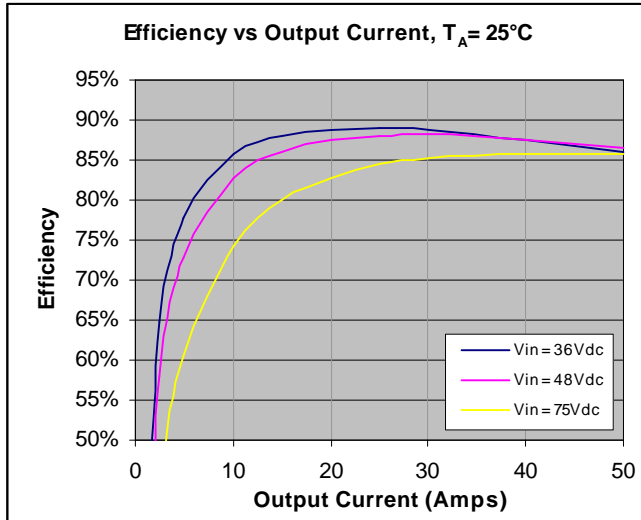

Figure 17. Efficiency vs. Load Current Curves at $T_A=25^\circ\text{C}$ for different input voltages with 300 LFM airflow directed from Pins 3 to 1.

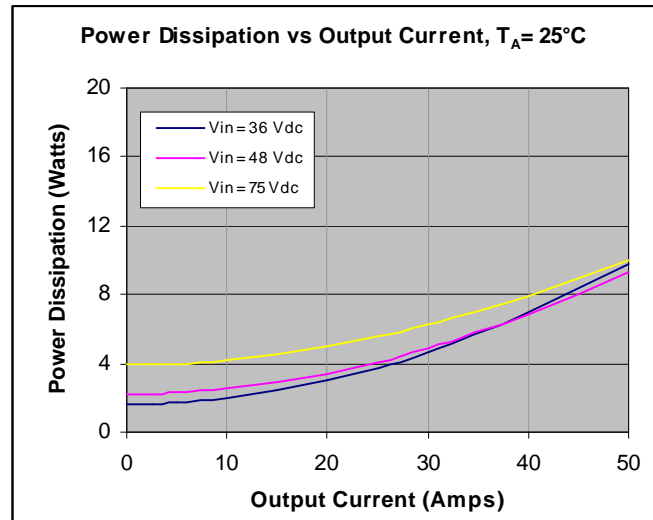

Figure 18. Power Dissipation vs. Load Current at $T_A=25^\circ\text{C}$ for different input voltages with 300 LFM airflow directed from Pins 3 to 1.

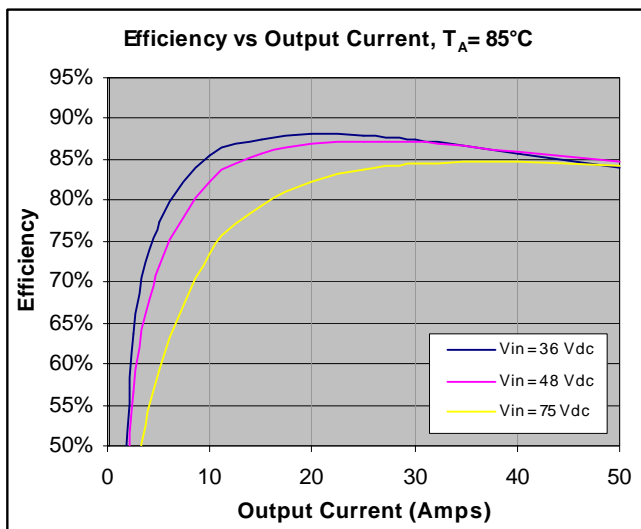

Figure 19. Efficiency vs. Load Current Curves at $T_A=85^\circ\text{C}$ for different input voltages with 300 LFM airflow directed from Pins 3 to 1.

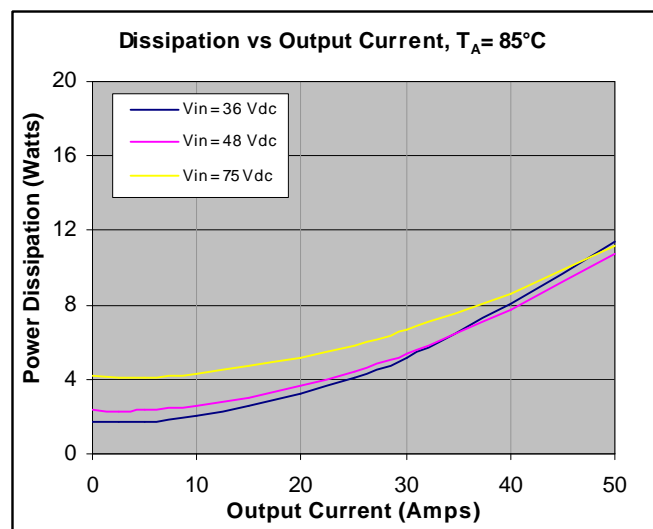

Figure 20. Power Dissipation vs. Load Current at $T_A=85^\circ\text{C}$ for different input voltages with 300 LFM airflow directed from Pins 3 to 1.



Technical Reference Notes
ALQ40/50 Series
(Open Frame Single Output Quarter Brick)



Performance Curves (continued)

CURRENT VS. TEMPERATURE CURVES

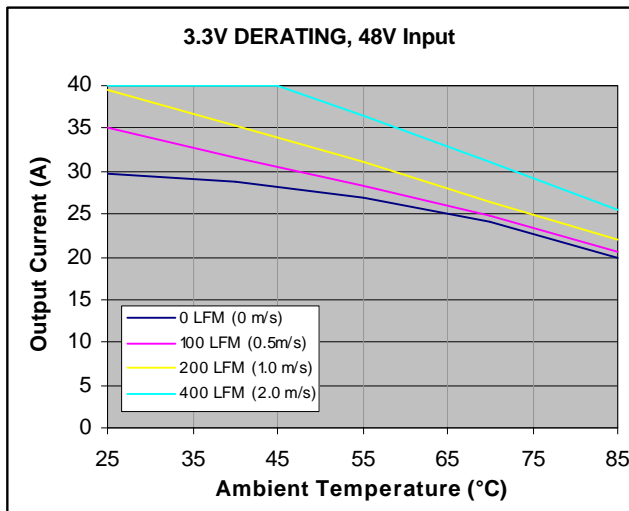

Figure 21. ALQ40F48 (3.3V) Output Derating curves at various airflow conditions directed across PIN 3 to 1 with the module mounted vertically.

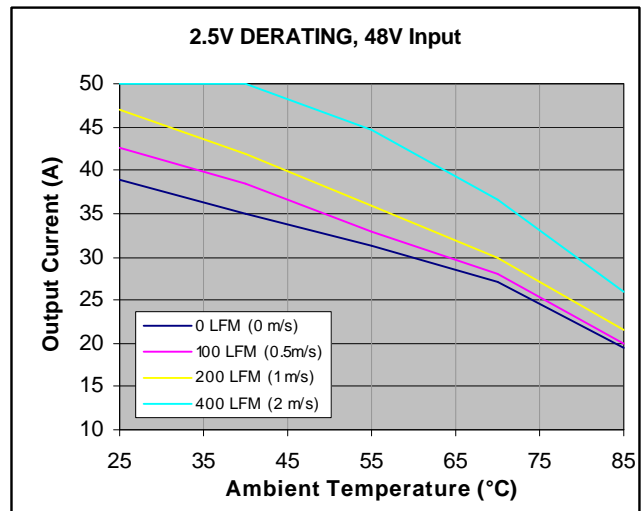

Figure 22. ALQ50G48 (2.5V) Output Derating curves at various airflow conditions directed across PIN 3 to 1 with the module mounted vertically.

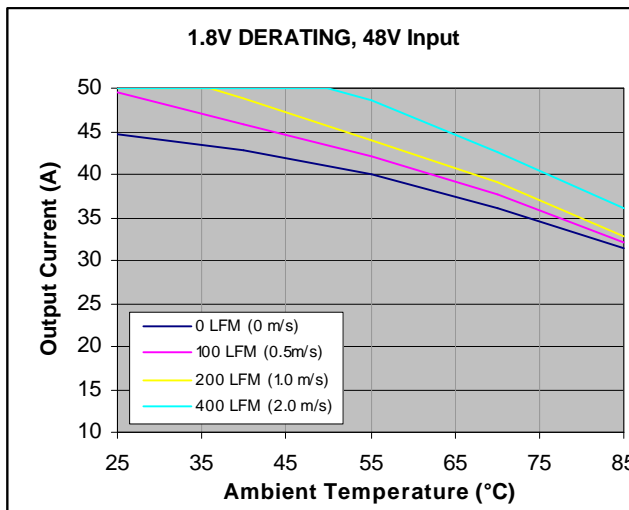

Figure 23. ALQ50Y48 (1.8V) Output Derating curves at various airflow conditions directed across PIN 3 to 1 with the module mounted vertically.

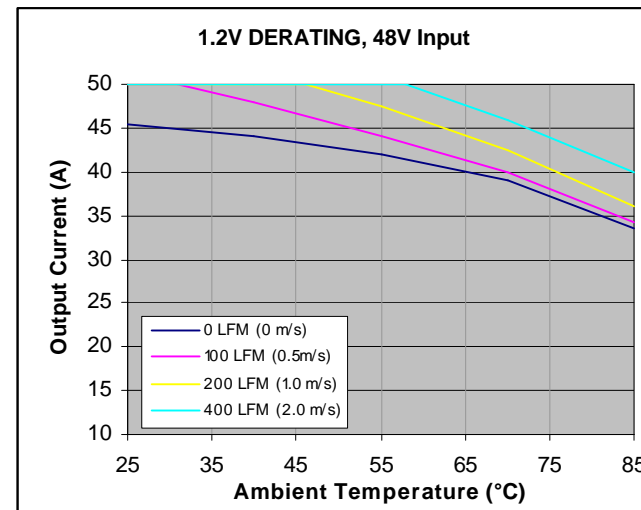

Figure 24. ALQ50K48 (1.2V) Output Derating curves at various airflow conditions directed across PIN 3 to 1 with the module mounted vertically.



Technical Reference Notes ALQ40/50 Series (Open Frame Single Output Quarter Brick)



Mechanical Specifications

Parameter	Device	Symbol	Min	Typ	Max	Unit
Dimension	All	L	-	2.30 [58.42]	-	in [mm]
		W	-	1.48 [37.59]	-	in [mm]
		H	-	0.36 [9.10]	-	in [mm]
Weight			-			g [oz]
PIN ASSIGNMENT						
1		+V _{IN}		5		-SENSE
2		ENABLE		6		TRIM
3		-V _{IN}		7		+SENSE
4		-V _O		8		+V _O

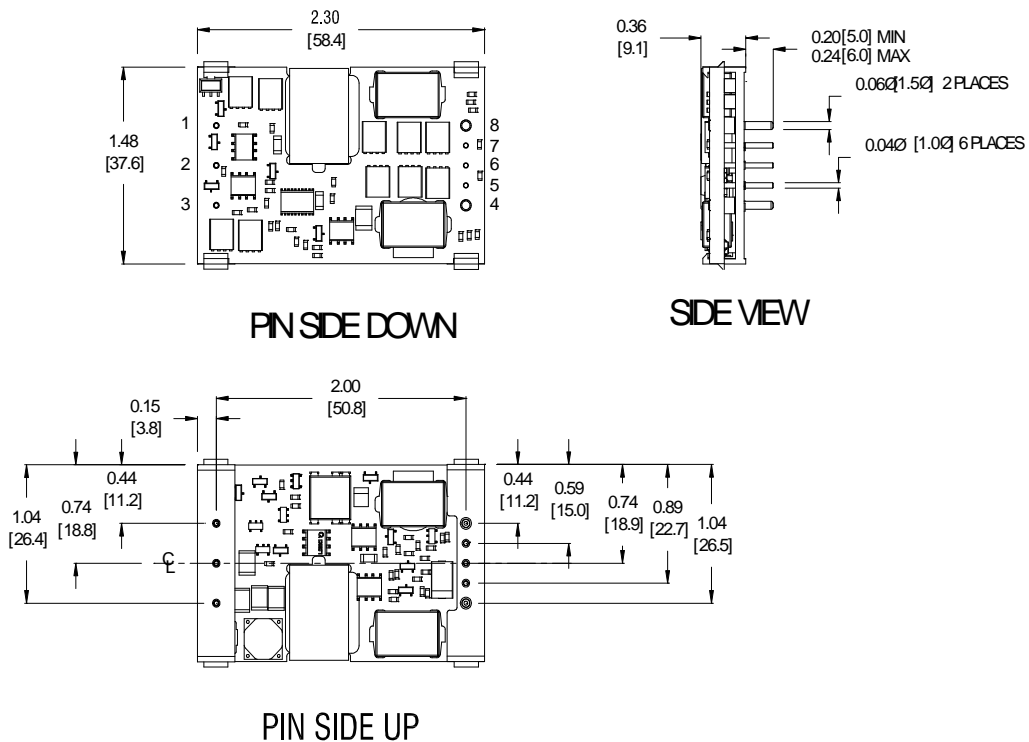

Figure 25. ALQ50 Series Mechanical Outline Drawing



Technical Reference Notes
ALQ40/50 Series
(Open Frame Single Output Quarter Brick)



Mechanical Specifications *(continued)*

SOLDERING CONSIDERATIONS

The ALQ50 series converters are compatible with standard wave soldering techniques. When wave soldering, the converter pins should be preheated for 20-30 seconds at 110°C and wave soldered at 260°C for less than 10 seconds.

When hand soldering, the iron temperature should be maintained at 425°C and applied to the converter pins for less than 5 seconds. Longer exposure can cause internal damage to the converter. Cleaning can be performed with cleaning solvent IPA or with water.

PART NUMBERING SCHEME FOR ORDERING

	OUTPUT VOLTAGE		ENABLE LOGIC
ALQ40 / 50	x	48	y
	F = 3.3V G = 2.5V Y = 1.8V K = 1.2V		N = Negative Enable "Blank" = Positive Enable (Default)

Please call 1-888-41-ASTEC for further inquiries
or visit us at www.astecpower.com