

**PART No. 2CLP44818**

for more information visit

[www.hammfg.com](http://www.hammfg.com)

Data subject to change without notice

Isometric drawing Not to Scale

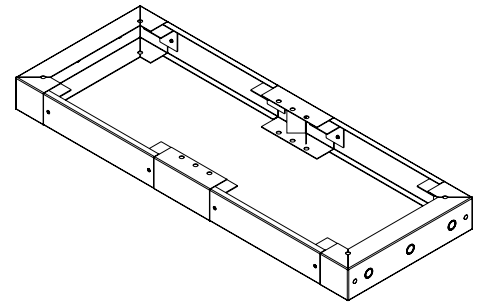

**ISOMETRIC VIEW**

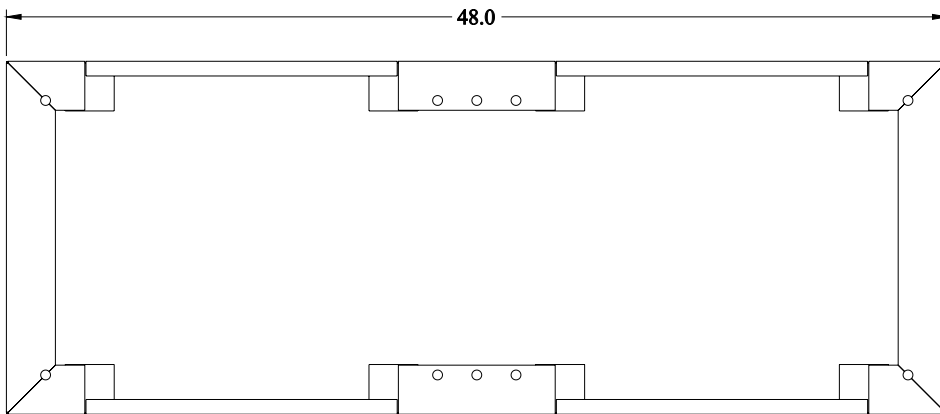

**TOP VIEW**

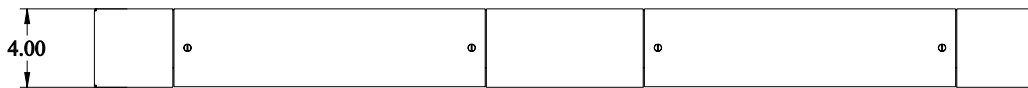

**FRONT VIEW**

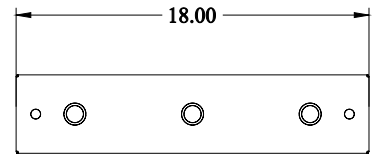

**RIGHT SIDE VIEW**