

20V N-Channel Power MOSFET

UM2302S SOT23-3

UM2302P SOT323

General Description

The UM2302 is a low threshold N-channel MOSFET, have extremely low on-resistance. This benefit provides the designer with an extremely efficient device for use in battery and load management applications. The device uses a space-saving, small-outline SOT23-3 or SOT323 package.

Applications

- Battery Packs
- Battery-powered Portable Equipment
- Cellular and Cordless Telephones

Features

- Drain-Source Voltage(max): 20V
- Low On-Resistance:
90mΩ@V_{GS}=4.5V
150mΩ@V_{GS}=2.5V
- Continuous Drain Current(max):
2A@25°C (SOT23-3)
1.6A@25°C (SOT323)

Pin Configurations

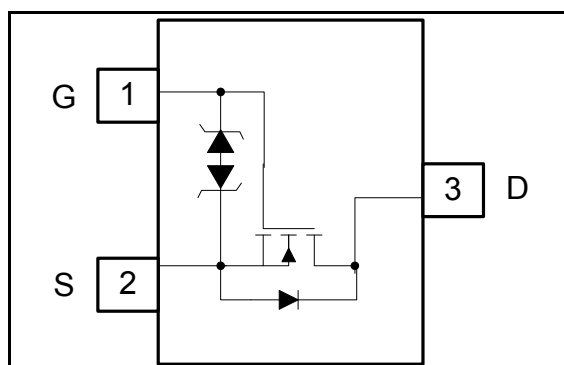

Top View

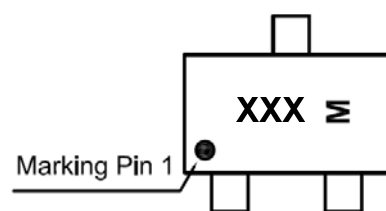

M: Month Code
XXX: UM2302S 10B
UM2302P VLC

Ordering Information

Part Number	Packaging Type	Marking Code	Shipping Qty
UM2302S	SOT23-3	10B	3000pcs/7 Inch Tape & Reel
UM2302P	SOT323	VLC	

Absolute Maximum Ratings

Symbol	Parameter	Value	Units
V _{DSS}	Drain-Source voltage	20	V
V _{GS}	Gate-Source voltage	±8	V
I _D	Continuous Drain Current (5s)	SOT23-3	2
		SOT323	1.6
I _{DP}	Drain Current Pulsed (Pulse Width ≤ 10μs, Duty Cycle ≤ 1%)	5	A

P _D	Power Dissipation	SOT23-3	0.86	W
		SOT323	0.5	
T _J	Junction Temperature		-55~150	°C
T _{stg}	Storage Temperature		-55~150	°C
R _{θJA}	Thermal Resistance, Junction-to-Ambient (≤5s)	SOT23-3	145	°C/W
		SOT323	250	
ESD	ESD Method 3015.8		2000	V

Electrical Characteristics (T_J=25°C, Unless otherwise noted)

Symbol	Parameter	Test Condition	Min	Typ	Max	Unit
Off Characteristics						
BV _{DSS}	Drain to Source Breakdown Voltage	V _{GS} =0V, I _D =250μA	20			V
I _{DSS}	Zero Gate Voltage Drain Current	V _{DS} =20V, V _{GS} =0V			0.1	μA
I _{GSS}	Gate-to-Source Leakage Current	V _{GS} =±8V, V _{DS} =0V			±10	μA
On Characteristics						
R _{DS(ON)}	Static Drain-to-Source On-Resistance ^a	V _{GS} =4.5V, I _D =1.0A		90	150	mΩ
		V _{GS} =2.5V, I _D =1.0A		150	200	
V _{GS(TH)}	Gate-Source Threshold Voltage	V _{DS} =V _{GS} , I _D =250μA	0.40		0.90	V
g _{fs}	Forward Transconductance ^a	V _{DS} =5V, I _D =2A		4.5		S
Dynamic Characteristics^b						
C _{iss}	Input Capacitance	V _{GS} =0V, V _{DS} =10V, f=1.0MHz		150		pF
C _{oss}	Output Capacitance			50		
C _{rss}	Reverse Transfer Capacitance			40		
Switching Characteristics^b						
td(on)	Turn-on Delay Time	V _{DD} =10V, R _L =2.78Ω, I _D =3.6A, V _{GEN} =4.5V, R _G =1Ω		8	15	ns
tr	Rise Time			10	25	
td(off)	Turn-off Delay Time			30	45	
tf	Fall Time			25	40	
Drain-Source Diode Characteristics and Maximum Ratings						
V _{SD}	Forward Diode Voltage	I _S =0.95A, V _{GS} =0V		0.7	1.2	V

a: Pulse test: pulse width ≤ 300μs, duty cycle ≤ 2%.

b: Guaranteed by design, not subject to production testing.

Typical Characteristics (T_J=25°C, Unless otherwise noted)

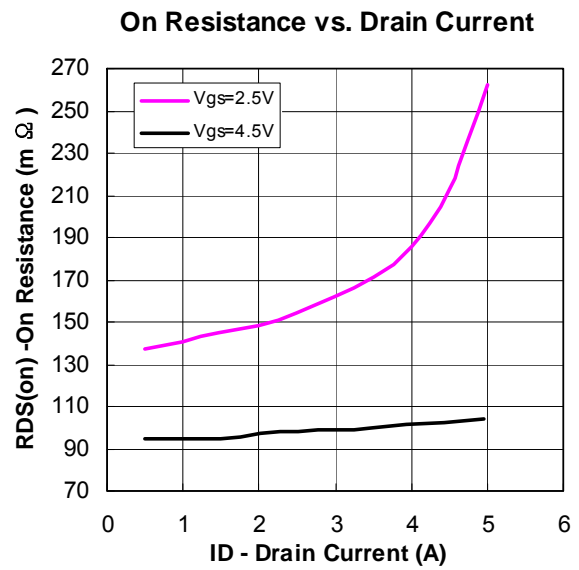
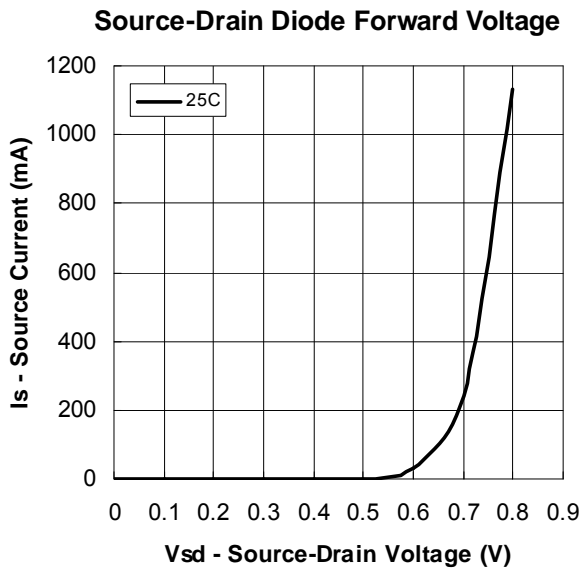
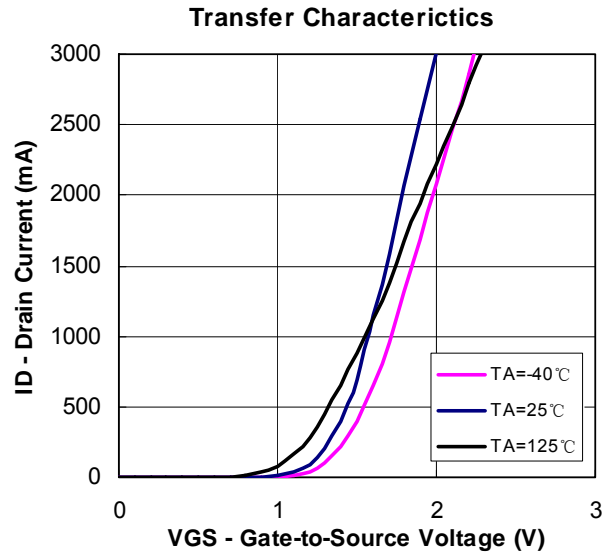
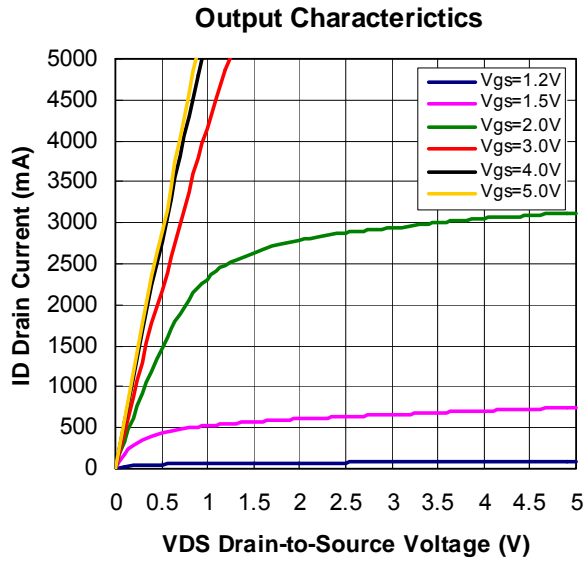

Typical Characteristics ($T_J=25^\circ\text{C}$, Unless otherwise noted)

On-Resistance vs. Gate-to-Source Voltage

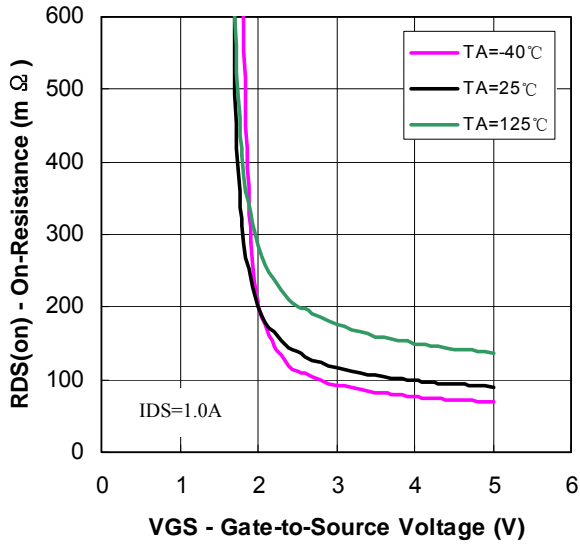

On-Resistance vs. Ambient Temperature

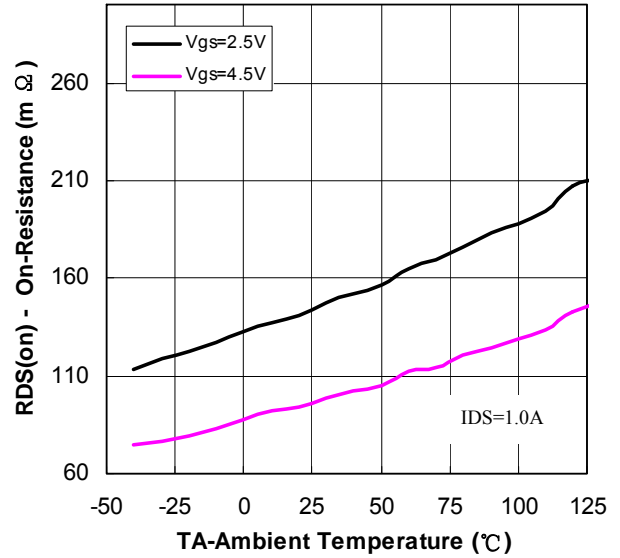

Threshold Voltage vs. Ambient Temperature

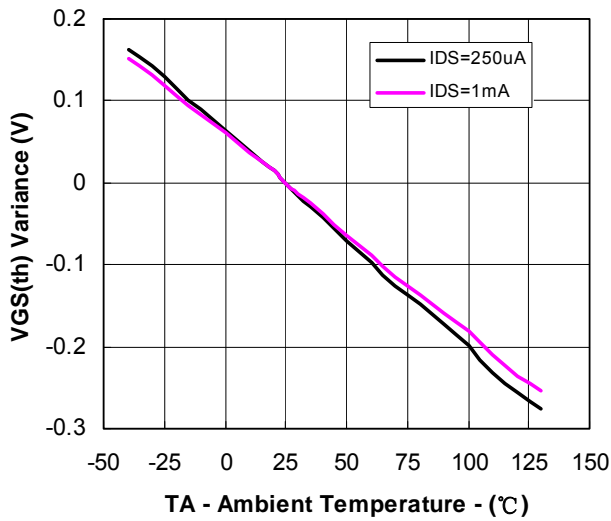

Package Information

UM2302S SOT23-3

Outline Drawing

DIMENSIONS				
Symbol	MILLIMETERS		INCHES	
	Min	Max	Min	Max
A	1.050	1.250	0.041	0.049
A1	0.000	0.100	0.000	0.004
A2	1.050	1.150	0.041	0.045
b	0.300	0.500	0.012	0.020
c	0.100	0.200	0.004	0.008
D	2.820	3.020	0.111	0.119
E	1.500	1.700	0.059	0.067
E1	2.650	2.950	0.104	0.116
e	0.950REF		0.037REF	
e1	1.800	2.000	0.071	0.079
L	0.550REF		0.022REF	
L1	0.300	0.600	0.012	0.024
θ	0°	8°	0°	8°

Land Pattern

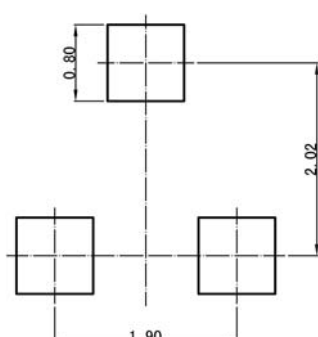
	<p>NOTES:</p> <ol style="list-style-type: none"> Compound dimension: 2.92×1.60; Unit: mm; General tolerance ±0.05mm unless otherwise specified; The layout is just for reference.
---	---

Tape and Reel Orientation



UM2302P SOT323

Outline Drawing

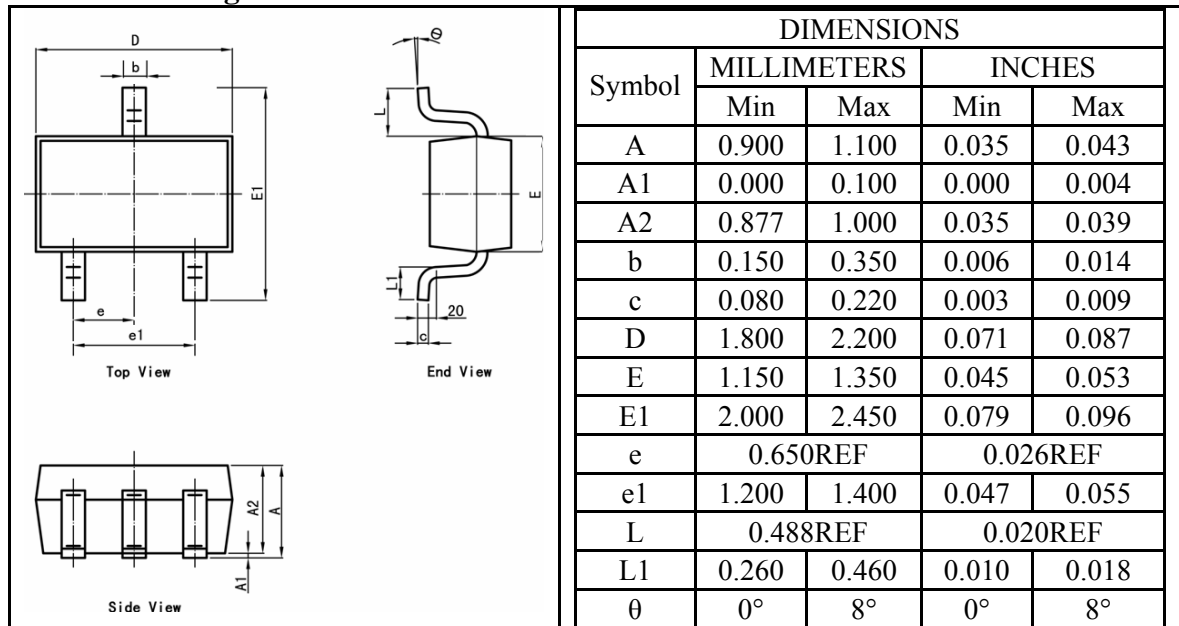

Land Pattern

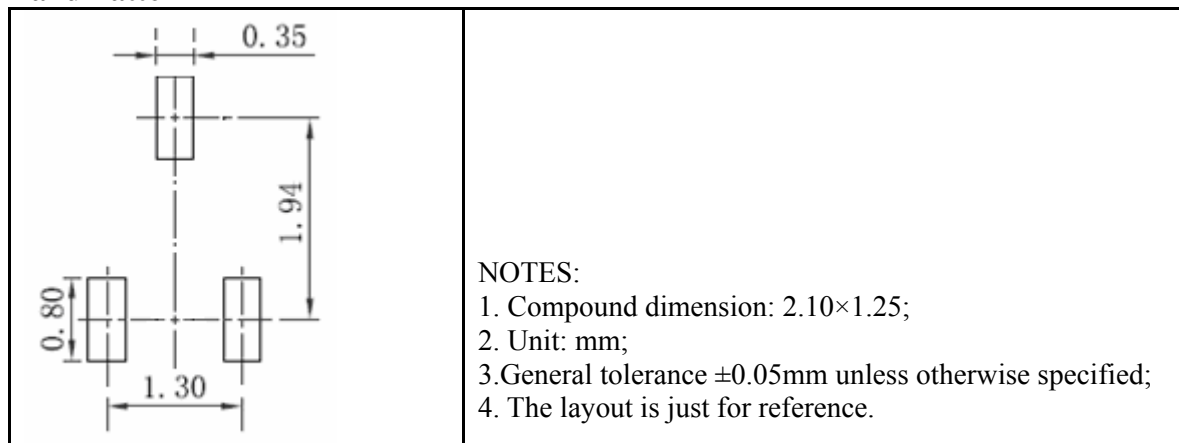

Tape and Reel Orientation



IMPORTANT NOTICE

The information in this document has been carefully reviewed and is believed to be accurate. Nonetheless, this document is subject to change without notice. Union assumes no responsibility for any inaccuracies that may be contained in this document, and makes no commitment to update or to keep current the contained information, or to notify a person or organization of any update. Union reserves the right to make changes, at any time, in order to improve reliability, function or design and to attempt to supply the best product possible.



Union Semiconductor, Inc

Add: 2F, No. 3, Lane 647 Songtao Road, Shanghai 201203

Tel: 021-51093966

Fax: 021-51026018

Website: www.union-ic.com